

High Quality Dental Instruments



SNAZAN
INTERNATIONAL



✉ info@snazanintl.com

☎ +92 306 7524947

☎ +92 52 3505094

www.snazanintl.com

📍 **Address:** New Adalat Garha
Sialkot 51310, PAKISTAN



Zahnzangen, Englische Form
 Extracting Forceps, English Pattern
 Pinze per estrazione, Forma Inglese
 Pinzas da extracción, Forma Inglesa
 Daviers, Forme Anglaise

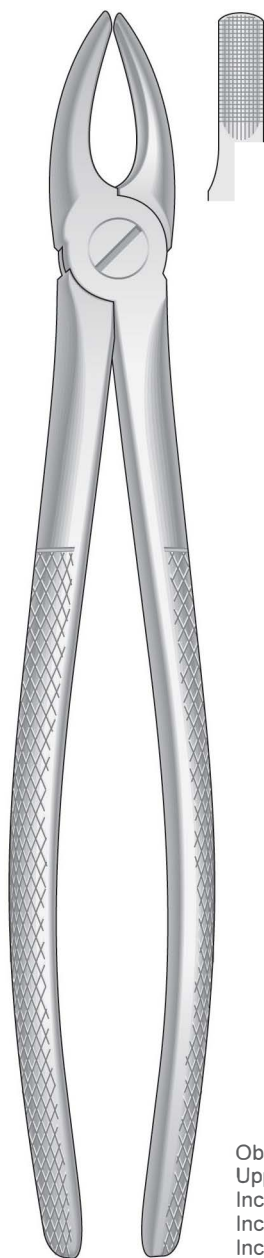

WI-10001
 Fig. 1

Obere Schneide- und Eckzähne
 Upper Incisors and cuspids
 Incisivi e canini superiori
 Incisivos y caninos superiores
 Incisives et canines supérieures

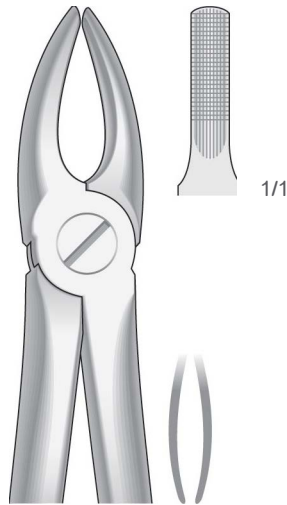

WI-10002
 Fig. 2

Obere Schneide- und Eckzähne
 Upper Incisors and cuspids
 Incisivi e canini superiori
 Incisivos y caninos superiores
 Incisives et canines supérieures



WI-10003
 Fig. 7

Obere Prämolaren
 Upper premolars
 Premolari superiori
 Premolares superiores
 Prémolaires supérieures

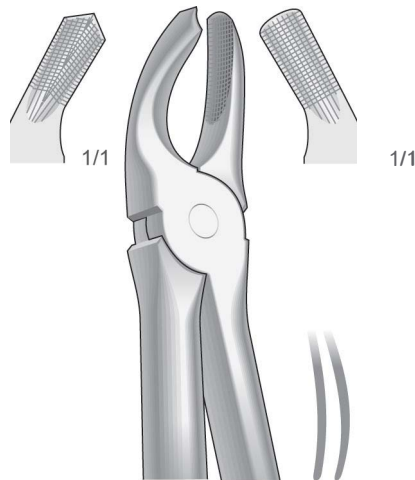

WI-10004
 Fig. 17

Obere Molaren, rechts
 Upper molars, right
 Molari superiori, destra
 Molares superiores, derechos
 Molaires supérieures, droites

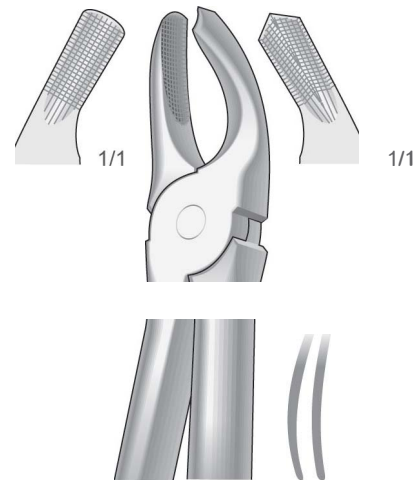

WI-10005
 Fig. 18

Obere Molaren, links
 Upper molars, left
 Molari superiori, sinistra
 Molares superiores, izquierdos
 Molaires supérieures, gauches



Zahnzangen, Englische Form
 Extracting Forceps, English Pattern
 Pinze per estrazione, Forma Inglese
 Pinzas da extracción, Forma Inglesa
 Daviers, Forme Anglaise

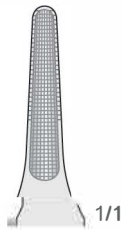

1/1

Obere Wurzeln und Schneidezähne
 Upper Roots and incisors
 Radici e incisivi superiori
 Raíces y incisivos superiores
 Racines et incisives supérieures

WI-10006
 Fig. 29

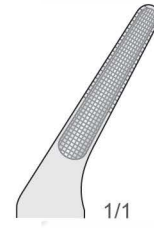

1/1

Obere Wurzeln
 Upper Roots
 Radici superiori
 Raíces superiores
 Racines supérieures

WI-10007
 Fig. 30



Zahnzangen, Englische Form
 Extracting Forceps, English Pattern
 Pinze per estrazione, Forma Inglese
 Pinzas da extracción, Forma Inglesa
 Daviers, Forme Anglaise

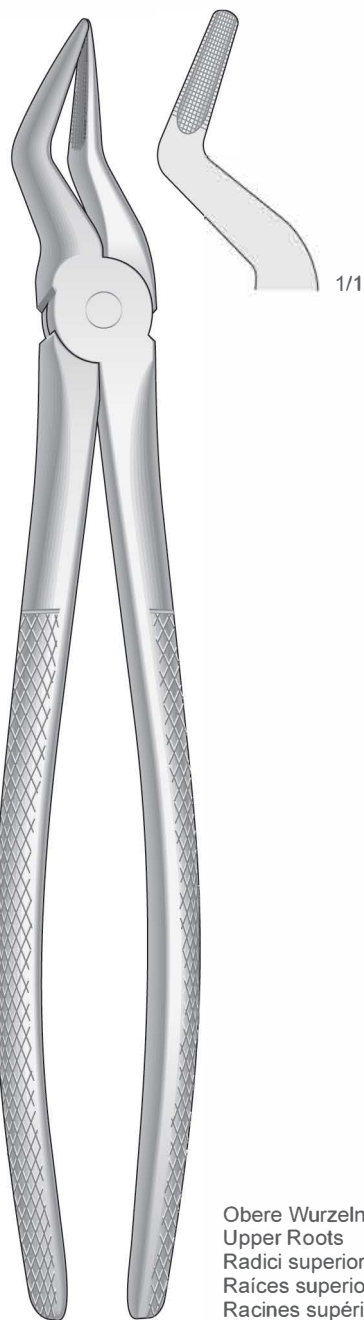

WI-10011
 Fig. 51

Obere Wurzeln
 Upper Roots
 Radici superiori
 Raíces superiores
 Racines supérieures

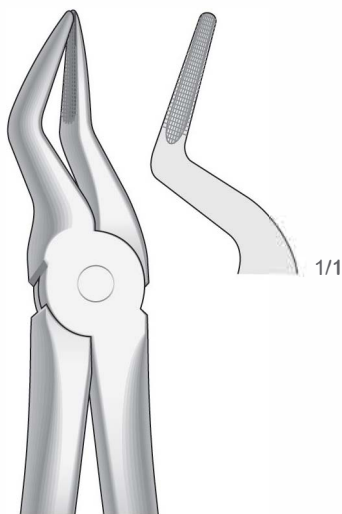

WI-10008
 Fig. 51A

Obere Wurzeln
 Upper Roots
 Radici superiori
 Raíces superiores
 Racines supérieures

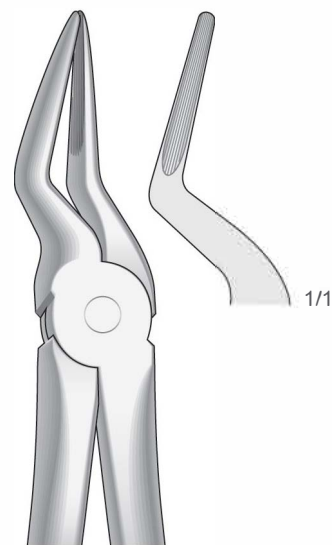

WI-10009
 Fig. 51AL

Obere Wurzeln
 Upper Roots
 Radici superiori
 Raíces superiores
 Racines supérieures

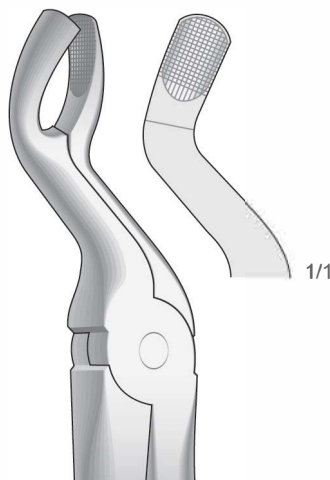

WI-10010
 Fig. 67A

Obere Dritte Molaren - Für Obere Weisheitszähne
 Upper molars - For Upper wisdom teeth
 Ottavi superiori - Per denti del giudizio superiori
 Molares superiores - Para muelas del juicio superiores
 Molaires supérieures - Pour dents de sagesse supérieures



Zahnzangen, Englische Form
 Extracting Forceps, English Pattern
 Pinze per estrazione, Forma Inglese
 Pinzas da extracción, Forma Inglesa
 Daviers, Forme Anglaise

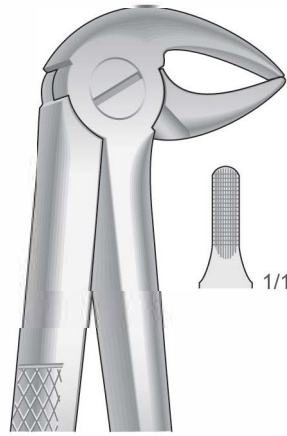

WI-10012
 Fig. 33

Untere Prämolaren, Schneidezähne und Wurzeln
 Lower incisors, premolars and roots
 Incisivi, premolari e radici inferiori
 Incisivos, premolares y raíces inferiores
 Incisives, prémolaires et racines inférieures

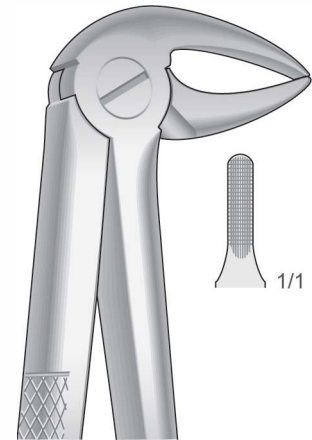

WI-10013
 Fig. 33A

Untere Wurzeln, schlankes Maul
 Lower roots, Slender jaw
 Radici inferiori, morso stretto
 Raíces inferiores, boca estrecha
 Racines inférieures, avec un bec très fin

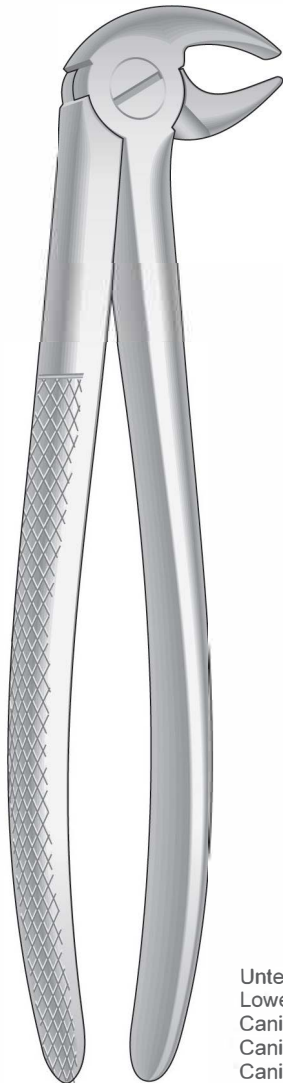

WI-10016
 Fig. 13

Untere Eckzähne und Prämolaren
 Lower cuspids and premolars
 Canini e premolari inferiori
 Caninos y premolares inferiores
 Canines et prémolaires inférieures

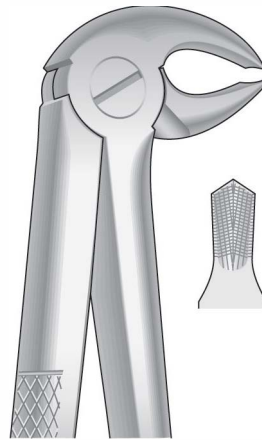
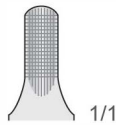

wi-10014
 Fig. 22

Untere Molaren
 Lower molars
 Molari inferiori
 Molares inferiores
 Molaires inférieures

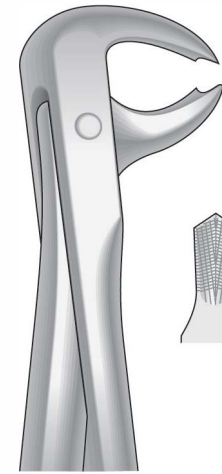
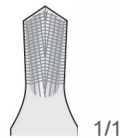

WI-10015
 Fig. 73

Untere Molaren
 Lower molars
 Molari inferiori
 Molares inferiores
 Molaires inférieures

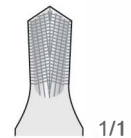



Zahnzangen, Englische Form
 Extracting Forceps, English Pattern
 Pinze per estrazione, Forma Inglese
 Pinzas da extracción, Forma Inglesa
 Daviers, Forme Anglaise

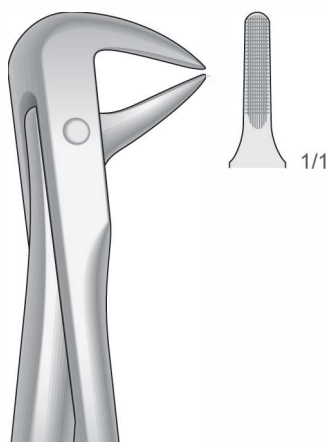

WI-10017
 Fig. 74N

Untere Wurzeln, schneide-und Eckzähne
 Lower roots, Incisors and bicuspid
 Radici, incisivi e canini inferiori
 Raíces, incisivos y caninos inferiores
 Racines, incisives et canines inférieures

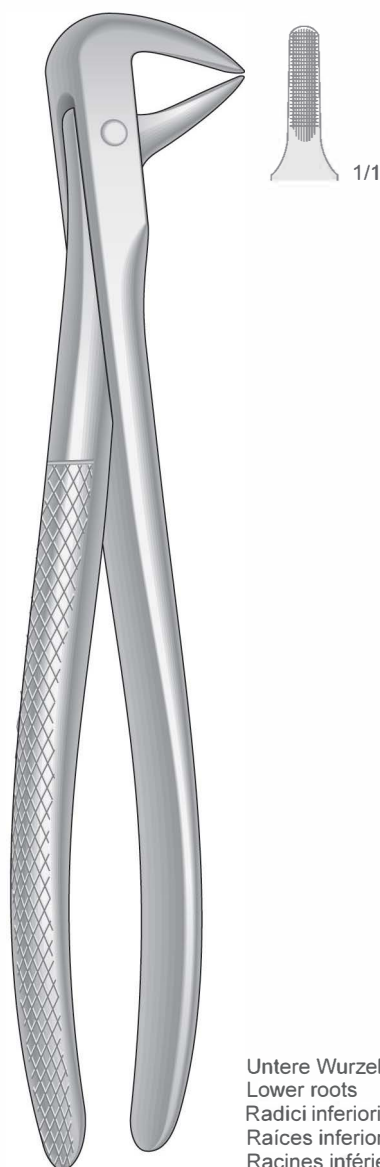

WI-10019
 Fig. 74

Untere Wurzeln
 Lower roots
 Radici inferiori
 Raíces inferiores
 Racines inférieures



WI-10018
 Fig. 75

Untere Eckzähne und Prämolaren
 Lower Cuspids and bicuspid
 Canini e premolari inferiori
 Caninos y premolares inferiores
 Canines et prémolaires inférieures



WI-10018A
 Fig. 86A

Untere Molaren
 Lower molars
 Molari inferiori
 Molares inferiores
 Molaires inférieures



Zahnzangen, Englische Form
 Extracting Forceps, English Pattern
 Pinze per estrazione, Forma Inglese
 Pinzas da extracción, Forma Inglesa
 Daviers, Forme Anglaise

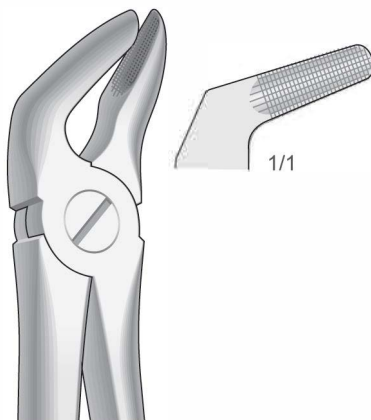

WI-10020
 Fig. 8

Untere Prämolaren
 Lower premolars
 Premolari inferiori
 Premolares inferiores
 Prémolaires inférieures

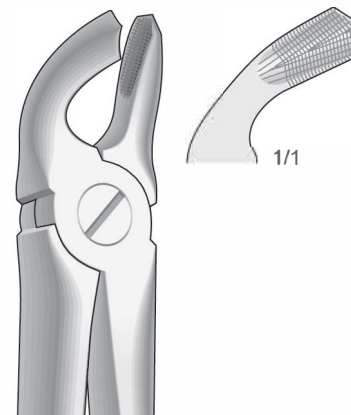

WI-10021
 Fig. 21

Untere Weisheitszähne und Molaren
 Lower wisdom teeth and molars
 Denti del giudizio e molari inferiori
 Muelas del juicio y Molares inferiores
 Dents de sagesse et molaires inférieures



WI-10024
 Fig. 4

Untere Schneide- und Eckzähne
 Lower Incisors and cuspids
 Incisivi e canini inferiori
 Incisivos y caninos inferiores
 Incisives et canines inférieures

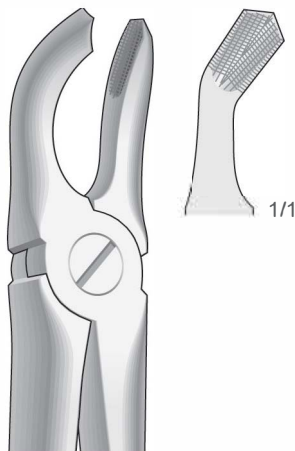
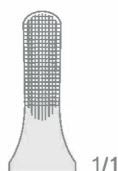

WI-10022
 Fig. 79

Untere Weisheitszähne
 Lower wisdom teeth
 Denti del giudizio inferiori
 Muelas del juicio inferiores
 Dent de sagesse inférieures

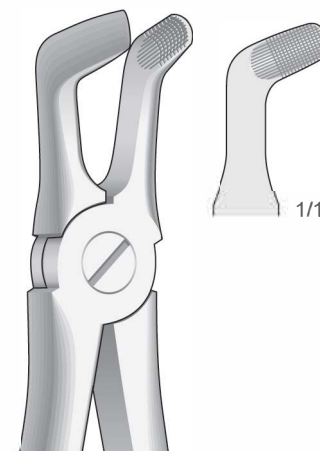

WI-10023
 Fig. 79A

Untere Molaren und Weisheitszähne
 Lower molars and wisdom teeth
 Molari e denti del giudizio inferiori
 Molares y muelas del juicio inferiores
 Molaires et dent de sagesse inférieures



Zahnzangen, Englische Form
 Extracting Forceps, English Pattern
 Pinze per estrazione, Forma Inglese
 Pinzas da extracción, Forma Inglesa
 Daviers, Forme Anglaise

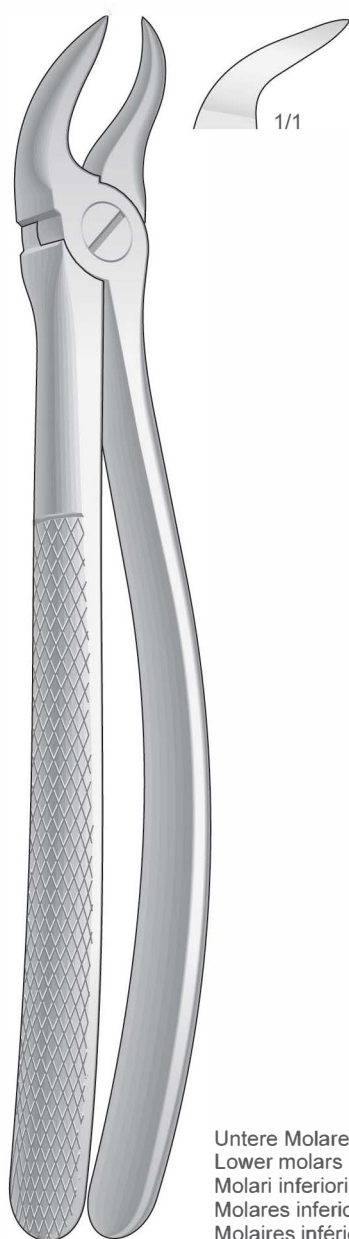

wi-10027
 Fig. 87

Untere Molaren
 Lower molars
 Molari inferiori
 Molares inferiores
 Molaires inférieures

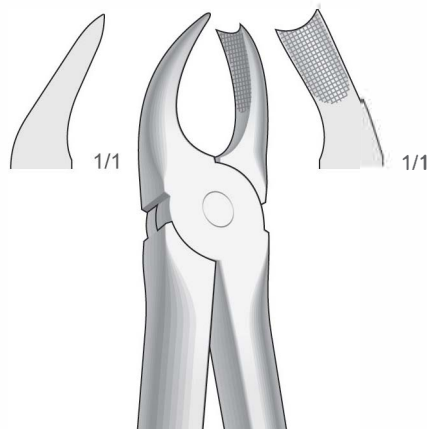

WI-10025
 Fig. 89

Obere Molaren, rechts
 Upper molars, right
 Molari superiori, destra
 Molares superiores, derechos
 Molaires supérieures, droites

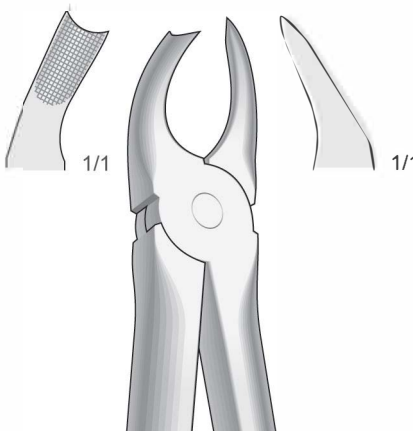

WI-10026
 Fig. 90

Obere Molaren, links
 Upper molars, left
 Molari superiori, sinistra
 Molares superiores, izquierdos
 Molaires supérieures, gauches



Zahnzangen, Englische Form
 Extracting Forceps, English Pattern
 Pinze per estrazione, Forma Inglese
 Pinzas da extracción, Forma Inglesa
 Daviers, Forme Anglaise



WI-10031
 Fig. 68

Untere Wurzeln
 Lower Roots
 Radici inferiori
 Raíces inferiores
 Racines inférieures



WI-10030
 Fig. 68A

Untere Wurzeln
 Lower Roots
 Radici inferiori
 Raíces inferiores
 Racines inférieures

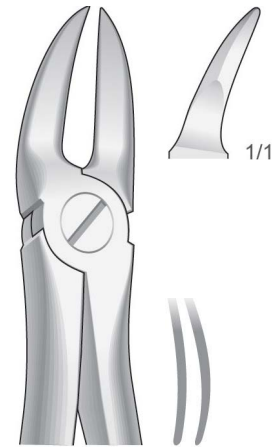

wi-10028
 Fig. 55

Zum Trennen oberer Molarenwurzeln
 For separating upper molar roots
 Per radici dei molari superiori, presa in profondità
 Para partir raíces de molares superiores, profundo
 Pour séparer les racines des molaires supérieures

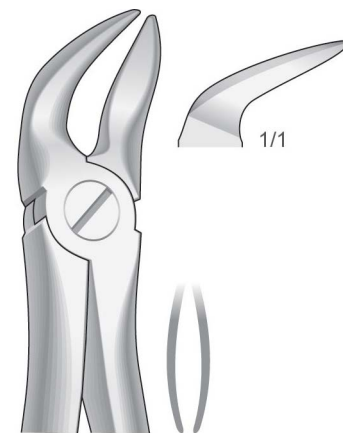

WI-10029
 Fig. 56

Zum Trennen Unterer Molarenwurzeln
 For separating lower molar roots
 Per radici dei molari inferiori, presa in profondità
 Para partir raíces de molares inferiores, profundo
 Pour séparer les racines des molaires inférieures



Zahnzangen, Englische Form
 Extracting Forceps, English Pattern
 Pinze per estrazione, Forma Inglese
 Pinzas da extracción, Forma Inglesa
 Daviers, Forme Anglaise

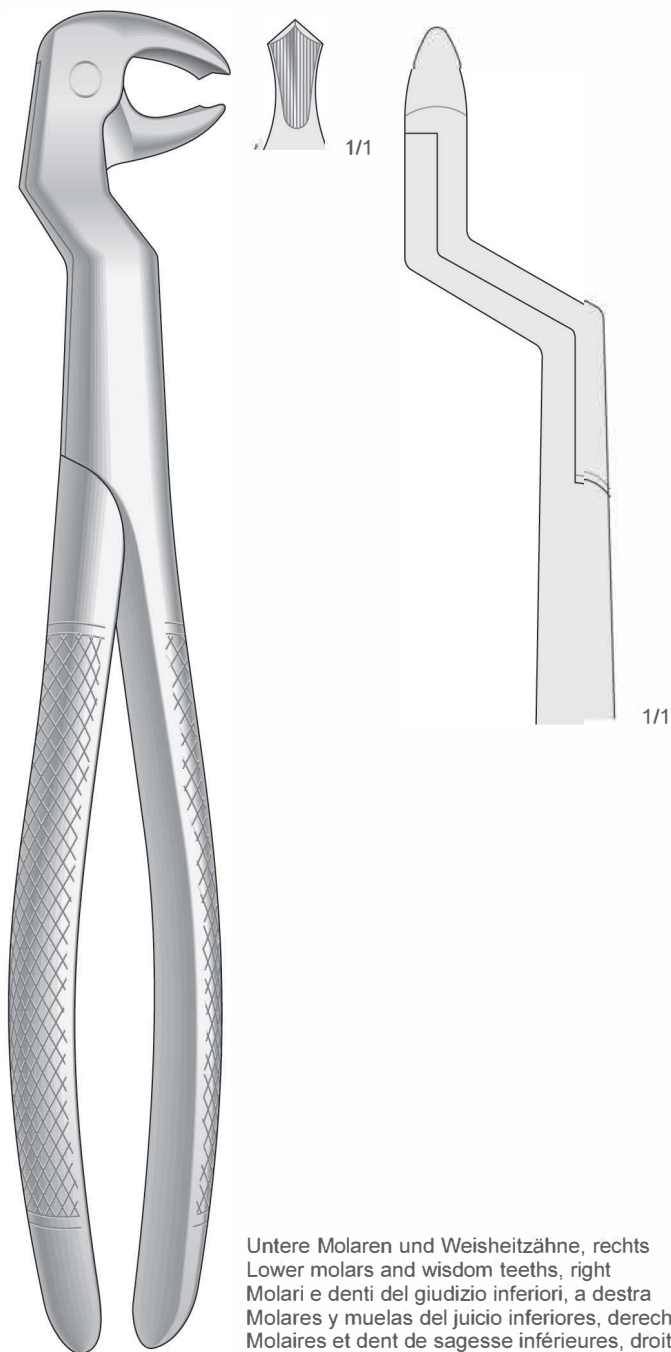

Untere Molaren und Weisheitszähne, rechts
 Lower molars and wisdom teeth, right
 Molari e denti del giudizio inferiori, a destra
 Molares y muelas del juicio inferiores, derecha
 Molaire et dent de sagesse inférieures, droites

WI-10031A

ROUTURIER
 22 ½ R

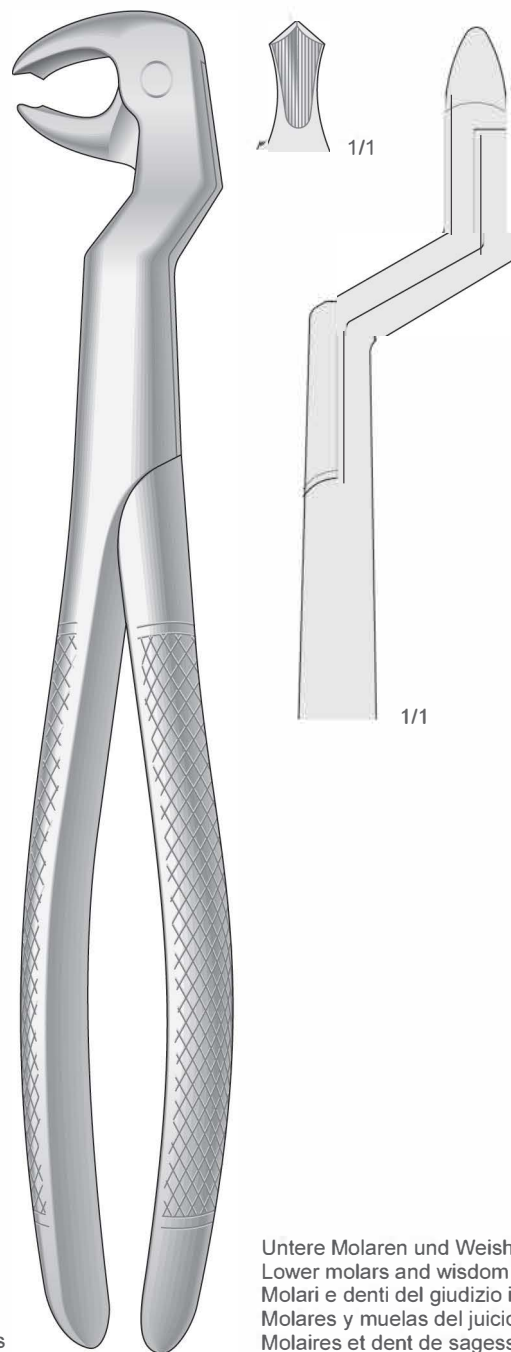

Untere Molaren und Weisheitszähne, links
 Lower molars and wisdom teeth, left
 Molari e denti del giudizio inferiori, a sinistra
 Molares y muelas del juicio inferiores, izquierda
 Molaire et dent de sagesse inférieures, gauches

WI-10031B

ROUTURIER
 22 ½ L



Zahnzangen, Englische Form
 Extracting Forceps, English Pattern
 Pinze per estrazione, Forma Inglese
 Pinzas da extracción, Forma Inglesa
 Daviers, Forme Anglaise

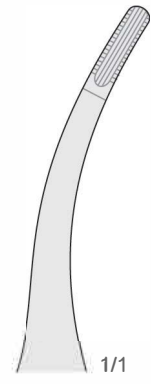
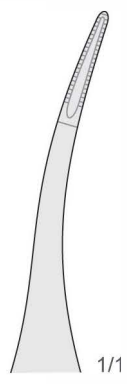
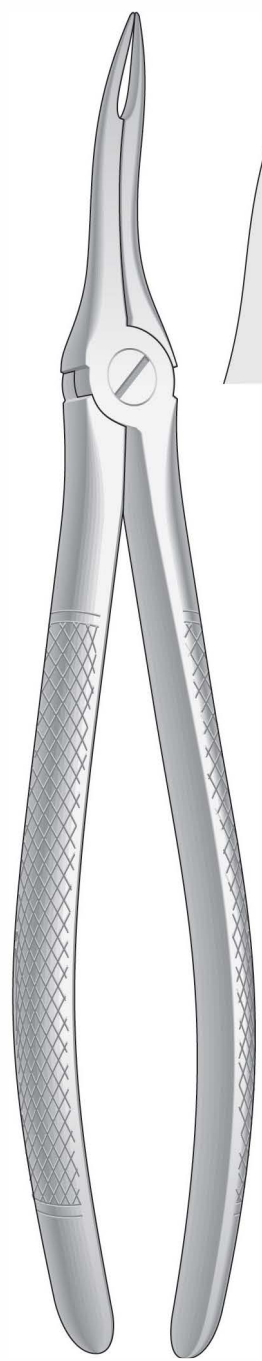

WI-10032
 Fig. 48 - 44

Obere Wurzeln
 Upper roots
 Radici superiori
 Raíces superiores
 Racines supérieures

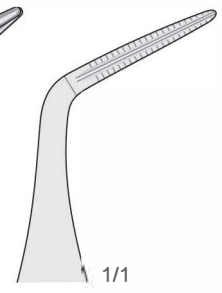
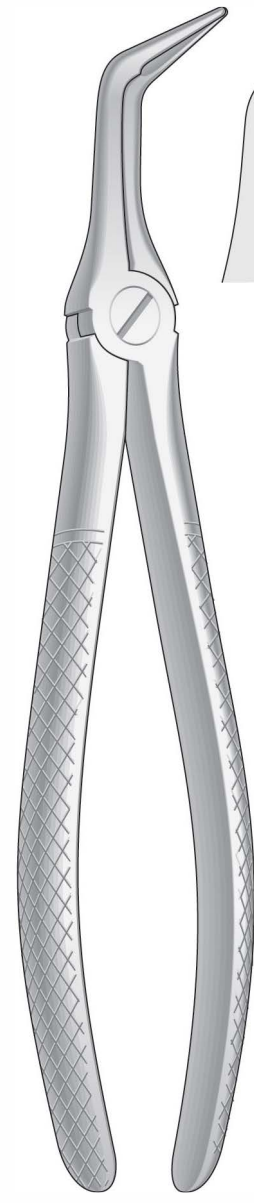

WI-10033
 Fig. 46L

Untere Wurzeln
 Lower roots
 Radici inferiori
 Raíces inferiores
 Racines inférieures

WI-10034
 Fig. 49

Obere Wurzeln sehr feine
 Upper very fine roots
 Radici superiori molto sottili
 Raíces superiores muy finas
 Racines supérieures très fines



Zahnzangen, Paßformgriff
 Extracting Forceps, Anatomical Handle
 Pinze per estrazione, Manico anatomico
 Pinzas da extracción, Mango anatómico
 Daviers, Manche anatomique

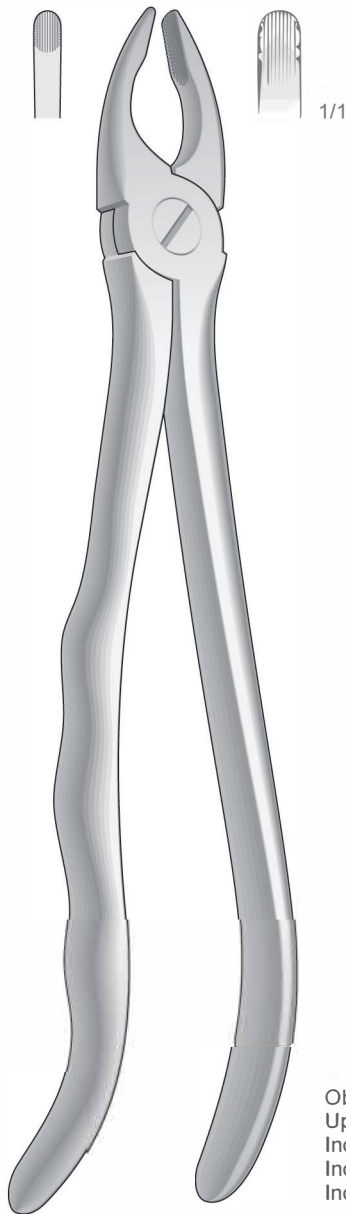

WI-10038
 Fig. 3

Obere Schneide- und Eckzähne
 Upper incisors and cuspids
 Incisivi e canini superiori
 Incisivos y caninos superiores
 Incisives et canines supérieures

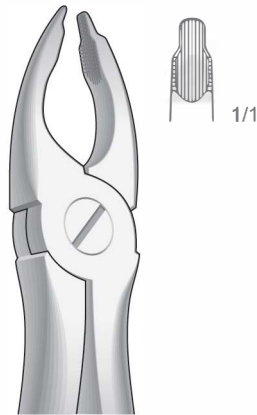

WI-10035
 Fig. 34

Obere Schneide- und Eckzähne
 Upper incisors and cuspids
 Incisivi e canini superiori
 Incisivos y caninos superiores
 Incisives et canines supérieures

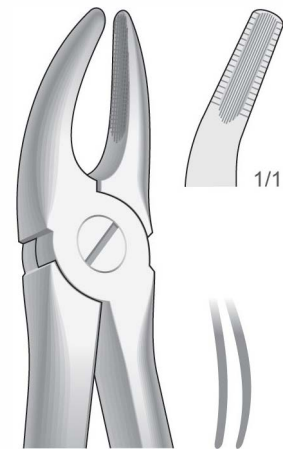

WI-10036
 Fig. 7

Obere Prämolaren
 Upper premolars
 Premolari superiori
 Premolares superiores
 Prémolaires supérieures

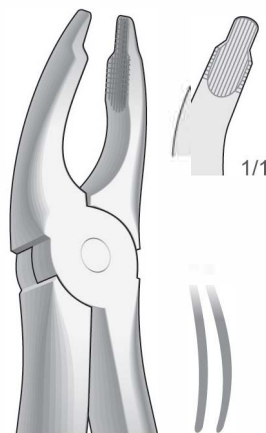

WI-10037
 Fig. 35

Obere Schneidezähne und Prämolaren, tiefgreifend
 Upper incisors and bicuspid, deep-gripping
 Incisivi e premolari superiori, presa in profondità
 Incisivos y premolares superiores, a gran calado
 Incisives et prémolaires supérieures, à attaque profonde



Zahnzangen, Paßformgriff
 Extracting Forceps, Anatomical
 Handle Pinze per estrazione,
 Manico anatomico Pinzas da
 extracción, Mango anatómico
 Daviers, Manche anatomique

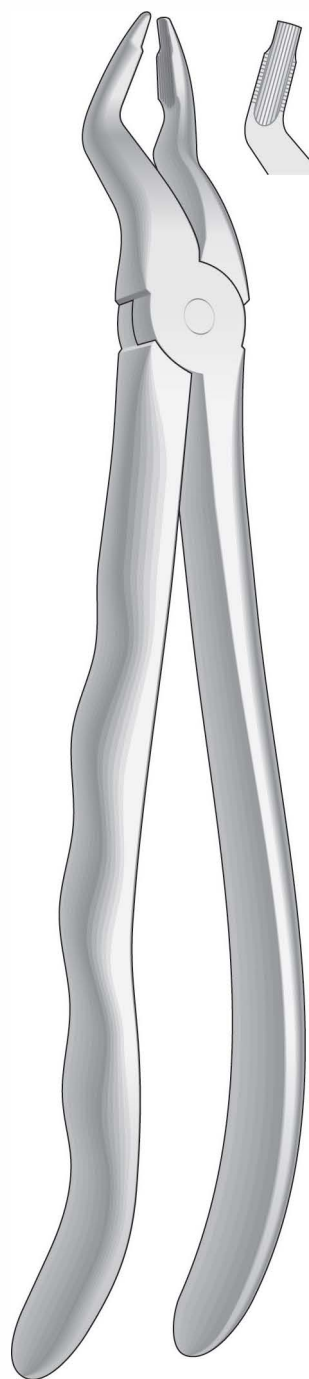

WI-10041
 Fig. 31

Obere Prämolaren
 Upper premolars
 Premolari superiori
 Premolares superiores
 Prémolaires supérieures

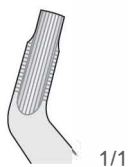

1/1

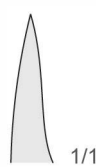

1/1

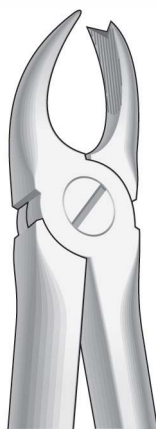

WI-10039
 Fig. 66R (89)

Obere Molaren, rechts
 Upper molars, right
 Molari superiori, destra
 Molares superiores, derechos
 Molaires supérieures, droites



1/1



1/1

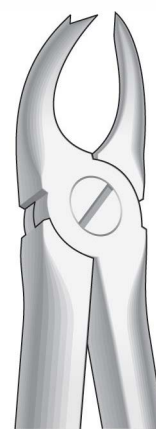

WI-10040
 Fig. 66L (90)

Obere Molaren, links
 Upper molars, left
 Molari superiori, sinistra
 Molares superiores, izquierdos
 Molaires supérieures, gauches

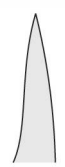

1/1



Zahnzangen, Paßformgriff
 Extracting Forceps, Anatomical Handle
 Pinze per estrazione, Manico anatomico
 Pinzas da extracción, Mango anatómico
 Daviers, Manche anatomique

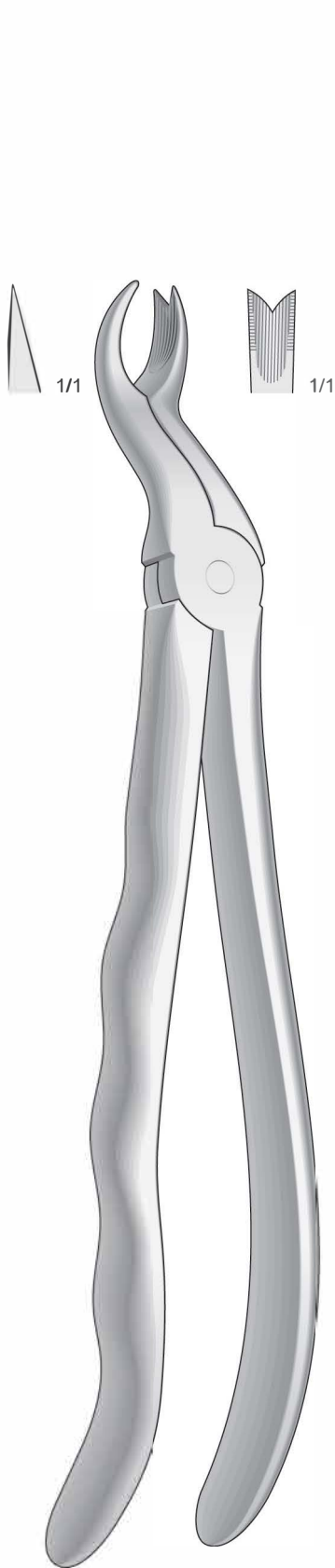

WI-10044
 Fig. 67R

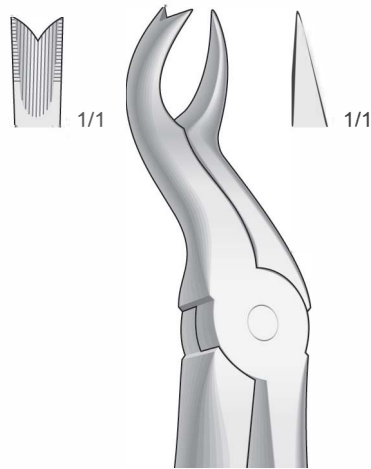

WI-10042
 Fig. 67L

Obere Molaren, links
 Upper molars, left
 Molari superiori, sinistra
 Molares superiores, izquierdos
 Molaires supérieures, gauches

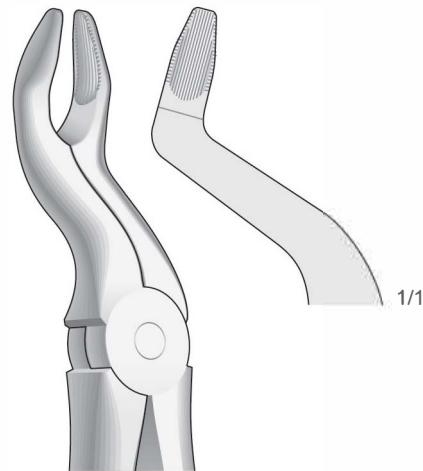

WI-10043
 Fig. 67N

Obere Molaren
 Upper molars
 Molari superiori
 Molares superiores
 Molaires supérieures

Obere Molaren, rechts
 Upper molars, right
 Molari superiori, destra
 Molares superiores, derechos
 Molaires supérieures, droites



Zahnzangen, Paßformgriff
 Extracting Forceps, Anatomical Handle
 Pinze per estrazione, Manico anatomico
 Pinzas da extracción, Mango anatómico
 Daviers, Manche anatomique

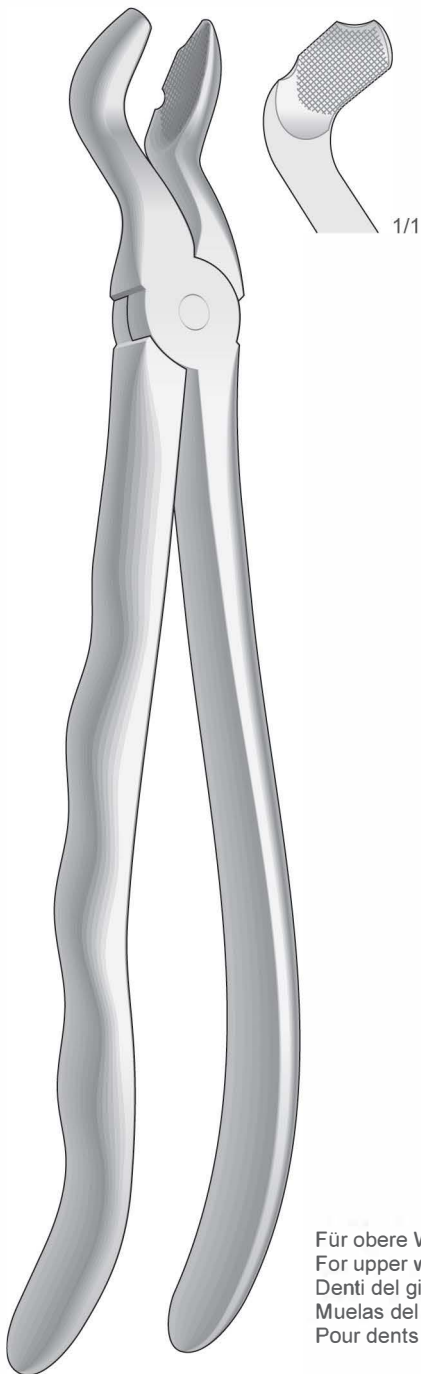

WI-10048
 FELSCH
 Fig. 80

Für obere Weisheitszähne, mit Fangvorrichtung
 For upper wisdom teeth, with retaining device
 Denti del giudizio superiori, con dispositivo di presa
 Muelas del juicio superiores, con dispositivo de retencion
 Pour dents de sagesse supérieures, mors conçus pour recueillir la dent

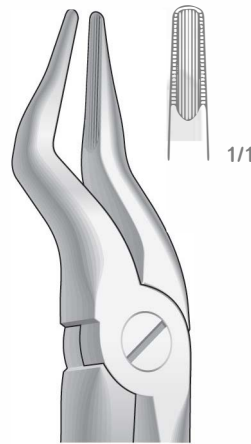

WI-10045
 Fig. 51B

Obere Dritte Molaren
 Upper molars
 Ottavi superiori
 Molares superiores
 Molaires supérieures

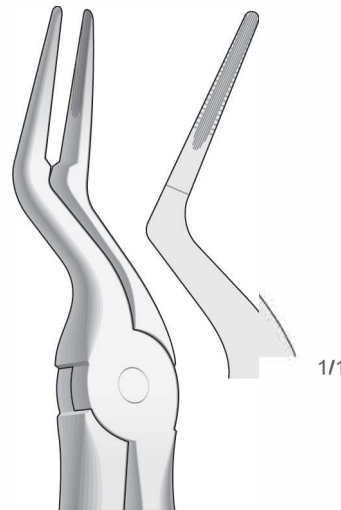

WI-10046
 Fig. 97

Obere Wurzelplitterzange
 Upper Root Fragments
 Frammenti e radici superiori
 Fragmentos de raíces superiores
 Fragments des racines supérieures

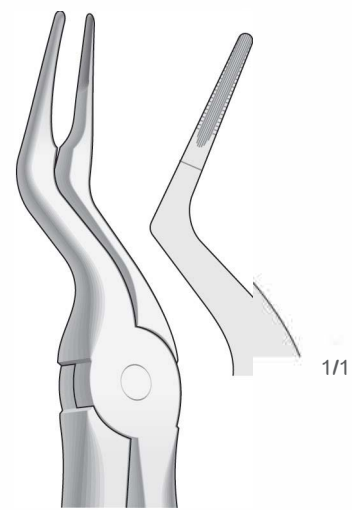

WI-10047
 Fig. 97B

Obere Wurzelplitterzange
 Upper Root Fragments
 Frammenti e radici superiori
 Fragmentos de raíces superiores
 Fragments des racines supérieures



Extracting Forceps, Anatomical Handle
Pinze per estrazione, Manico anatomico
Pinzas da extracción, Mango anatómico
Daviers, Manche anatomique

Obere Wurzeln sehr feine
Upper very fine roots
Radici superiori molto sottili
Raíces superiores muy finas
Racines supérieures très fines

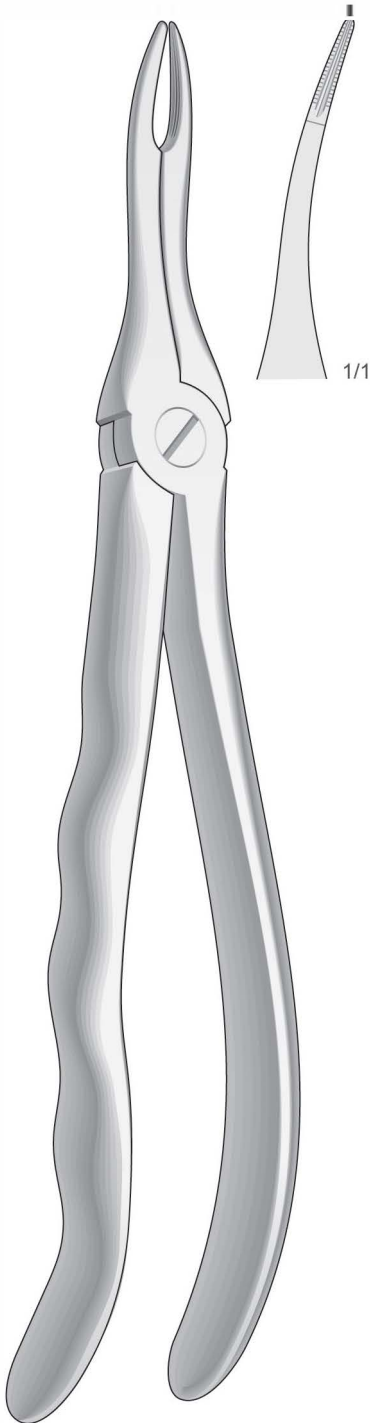

WI-10049
Fig. 49

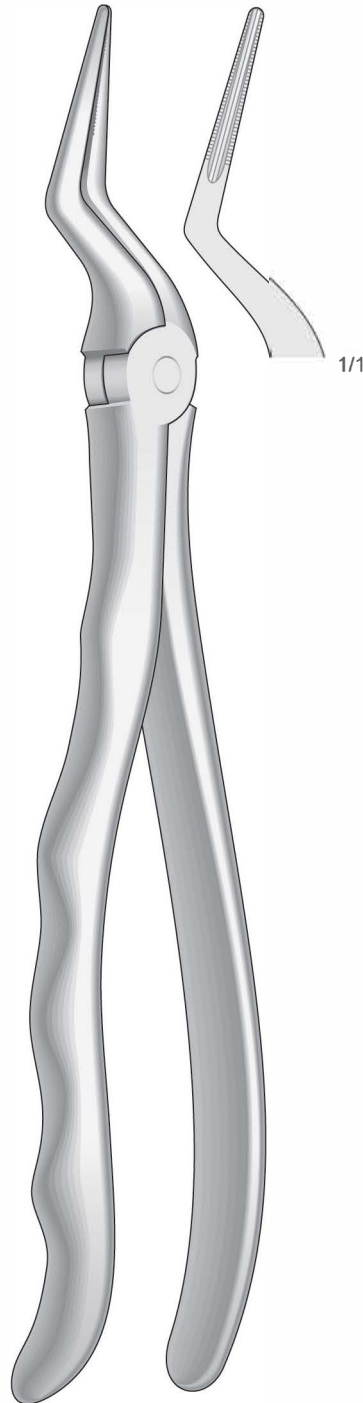

WI-10050
Fig. 51LX

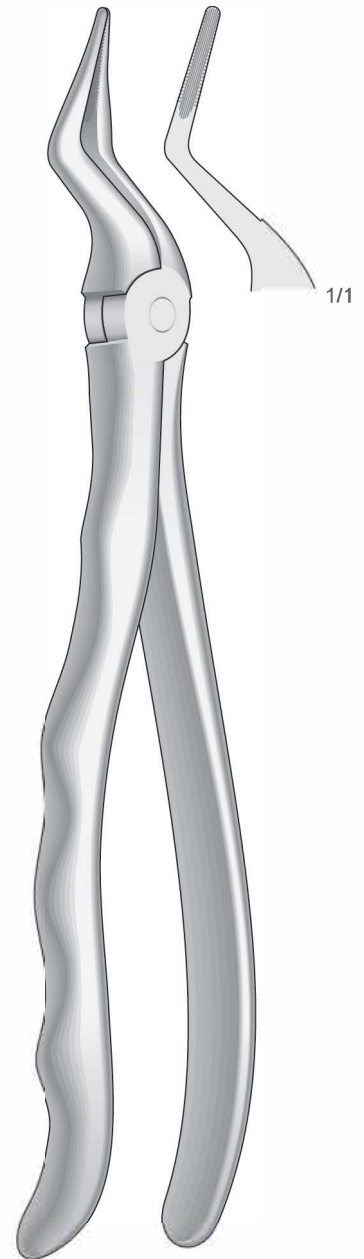

WI-10051
Fig. 351S



Zahnzangen, Paßformgriff
 Extracting Forceps, Anatomical Handle
 Pinze per estrazione, Manico anatomico
 Pinzas da extracción, Mango anatómico
 Daviers, Manche anatomique

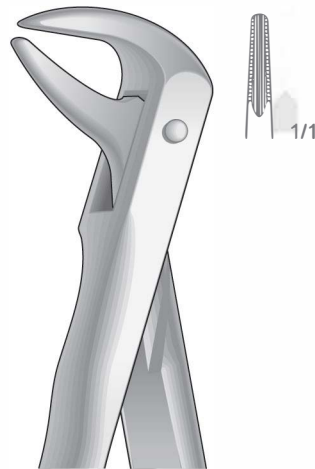

WI-I0052
 Fig. 74N

Untere Wurzeln Schneide- und Eckzähne
 Lower roots, incisors and cuspids
 Radici, incisivi e canini inferiori
 Raíces, incisivos y caninos inferiores
 Racines, incisives et canines inférieures

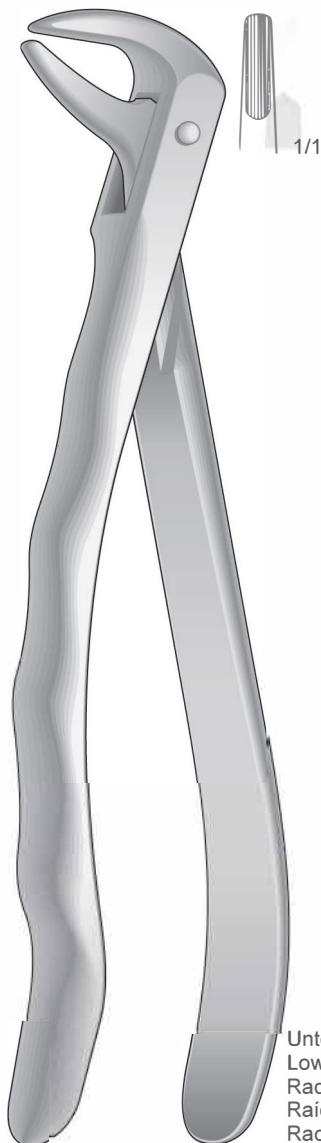

WI-I0055
 Fig. 74

Untere Wurzeln Schneide- und Eckzähne
 Lower roots, incisors and cuspids
 Radici, incisivi e canini inferiori
 Raíces, incisivos y caninos inferiores
 Racines, incisives et canines inférieures



WI-I0053
 Fig. 36

Untere Wurzeln Schneide- und Eckzähne
 Lower roots, incisors and cuspids
 Radici, incisivi e canini inferiori
 Raíces, incisivos y caninos inferiores
 Racines, incisives et canines inférieures



WI-I0054
 Fig. 36N

Untere Wurzeln Schneide- und Eckzähne
 Lower roots, incisors and cuspids
 Radici, incisivi e canini inferiori
 Raíces, incisivos y caninos inferiores
 Racines, incisives et canines inférieures



Zahnzangen, Paßformgriff
 Extracting Forceps, Anatomical Handle
 Pinze per estrazione, Manico anatomico
 Pinzas da extracción, Mango anatómico
 Daviers, Manche anatomique



WI-I0056
 Fig. 59

Untere Wurzelplitterzange
 Lower Root Fragments
 Frammenti e radici inferiori
 Fragmentos de raíces inferiores
 Fragments des racines inférieures



wi-I0057
 Fig. 86C

Untere Molaren mit kariesen oder abgebrochenen Kronen
 Lower molars with carious or broken caps
 Molari inferiori con corone cariate o spezzate
 Molares inferiores con coronas rotas o cariadas
 Molaires inférieures avec couronnes cariées ou cassées

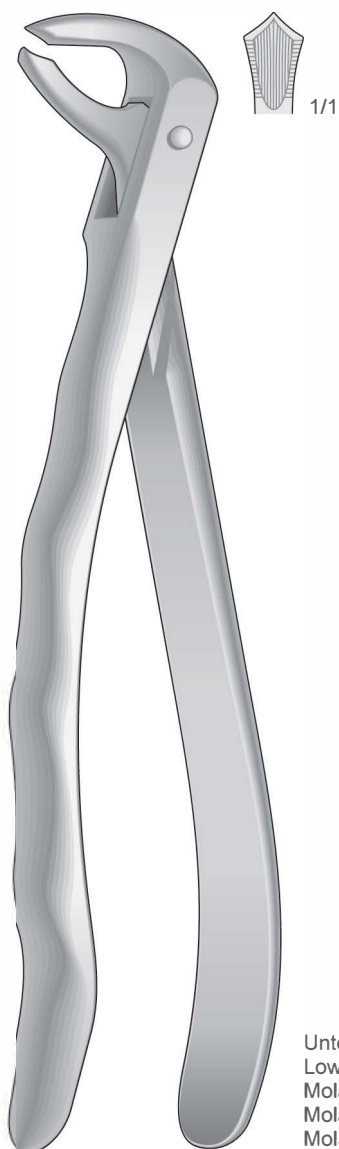

WI-I0059
 Fig. 73

Untere Molaren
 Lower molars
 Molari inferiori
 Molares inferiores
 Molaires inférieures

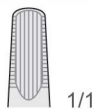

WI-I0057A
 Fig. 13

Untere Prämolaren und Eckzähne
 Lower premolars and cuspids
 Canini e premolari inferiori
 Caninos y premolares inferiores
 Canines et prémolaires inférieures

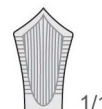

WI-I0058
 Fig. 22

Untere Molaren
 Lower molars
 Molari inferiori
 Molares inferiores
 Molaires inférieures



Zahnzangen, Paßformgriff
 Extracting Forceps, Anatomical Handle
 Pinze per estrazione, Manico anatomico
 Pinzas da extracción, Mango anatómico
 Daviers, Manche anatomique

Untere Weisheitszähne
 Lower wisdom teeth
 Denti del giudizio inferiori
 Muelas del juicio inferiores
 Dent de sagesse inférieures

Untere Prämolaren
 Lower premolars
 Premolari inferiori
 Premolares inferiores
 Prémolaires inférieures

Untere Molaren
 Lower Molars
 Molari inferiori
 Molares inferiores
 Molaires inférieures

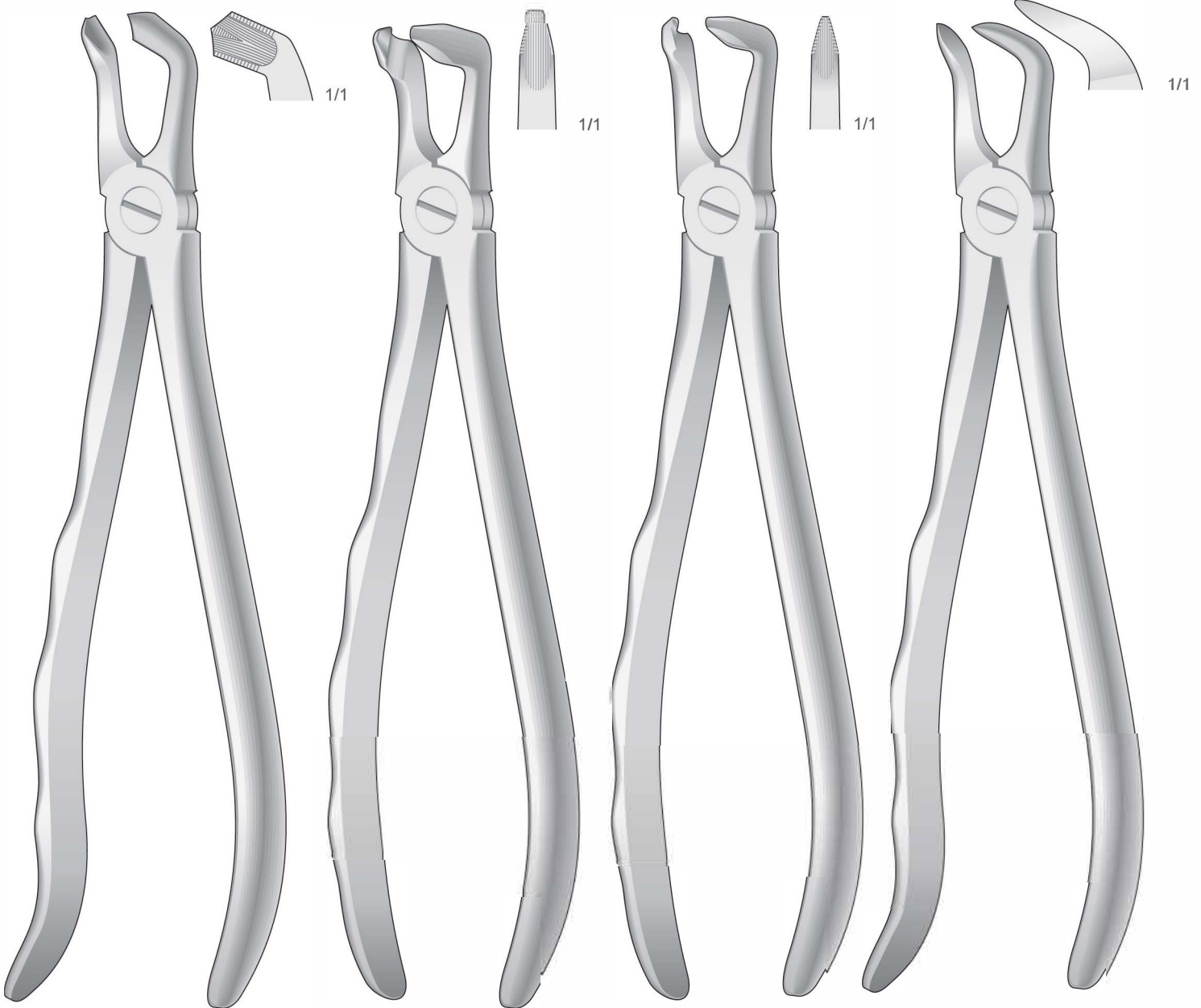

WI-I0060
 Fig. 79

WI-I0061
 Fig. 79N

WI-I0062
 Fig. 46N

WI-I0063
 Fig. 87



Zahnzangen, Paßformgriff
Extracting Forceps, Anatomical Handle
Pinze per estrazione, Manico anatomico
Pinzas da extracción, Mango anatómico
Daviers, Manche anatomique



WI-10064
Fig. 46LX

Untere Wurzeln
Lower roots
Radici inferiori
Raíces inferiores
Racines inférieures



WI-10065
Fig. 46L

Untere Wurzeln
Lower roots
Radici inferiori
Raíces inferiores
Racines inférieures



Zahnzangen, Paßformgriff
Extracting Forceps, Anatomical Handle
Pinze per estrazione, Manico anatomico
Pinzas da extracción, Mango anatómico
Daviers, Manche anatomique

Untere Molaren und Weisheitszähne
Lower molars and wisdom teeth
Molari e denti del giudizio inferiori
Molares y muelas del juicio inferiores
Molaires et dent de sagesse inférieures



1/1

Links
Left
Sinistra
Izquierdos
Gauches

WI-I0065A

I-22 ½ L

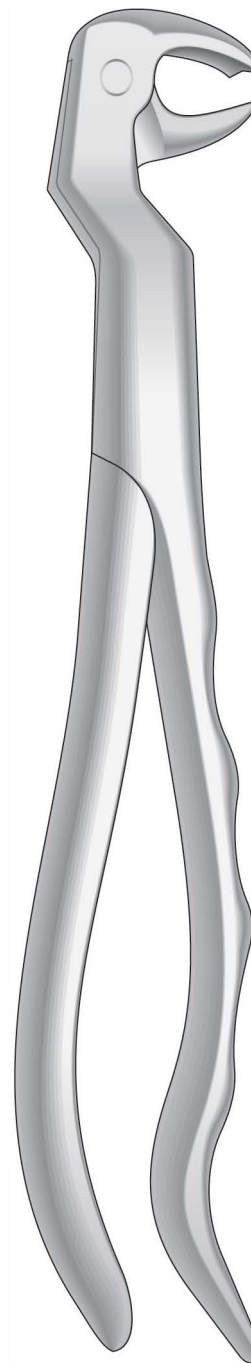

1/1

Rechts
Right
Destra
Derechos
Droites

WI-I0065B

I-22 ½ R



Zahnzangen, Paßformgriff
 Extracting Forceps, Anatomical Handle
 Pinze per estrazione, Manico anatomico
 Pinzas da extracción, Mango anatómico
 Daviers, Manche anatomique

Untere Wurzeln sehr feine
 Lower very fine roots
 Radici inferiori molto sottili
 Raíces inferiores muy finas
 Racines inférieures très fines

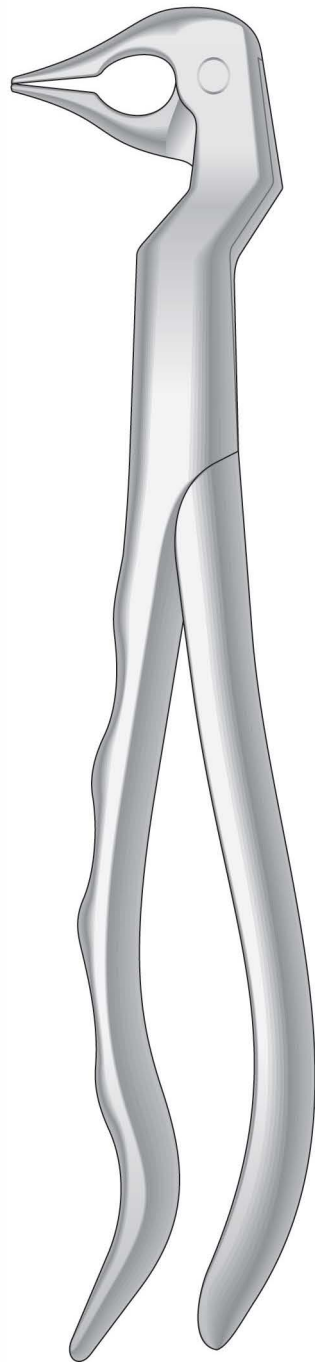

Links
 Left
 Sinistra
 Izquierdos
 Gauches

WI-10066
 Fig.133

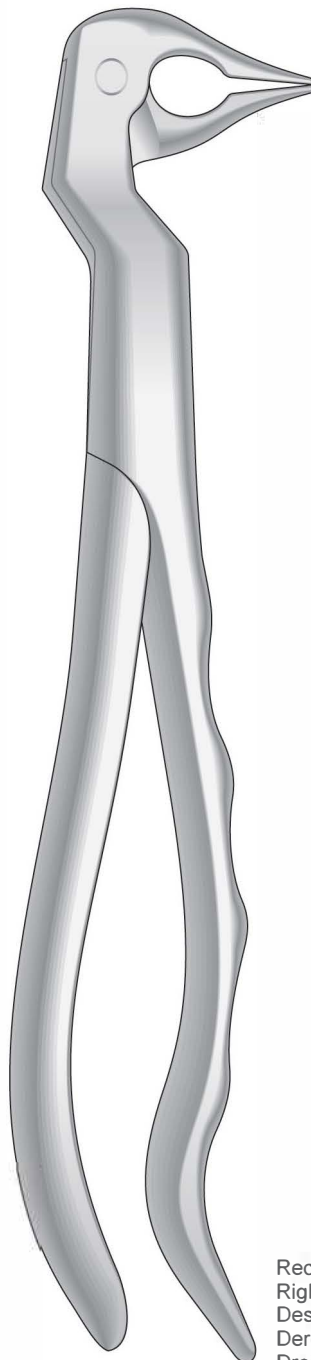

Rechts
 Right
 Destra
 Derechos
 Droites

WI-I0067
 Fig.133



WI-I0068
 Fig.333S



Zahnzangen, Amerikanische Form
 Extracting Forceps, American Pattern
 Pinze per estrazione, Forma Americana
 Pinzas da extracción, Forma Americana
 Daviers, Forme Américaine



WI-10072
 Fig. 1

Obere Schneide- und Eckzähne
 Upper incisors and cuspids
 Incisivi e canini superiori
 Incisivos y caninos superiores
 Incisives et canines supérieures

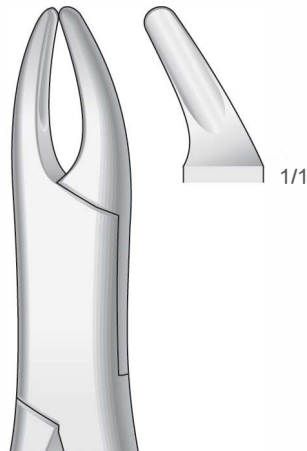

CRYER
WI-10069
 Fig. 150

Obere Prämolaren, Schneidezähne, Wurzeln
 Upper Bicuspids, incisors and roots
 Premolari, incisivi e radici superiori
 Premolares, incisivos y raíces superiores
 Prémolaires, incisives et racines supérieures

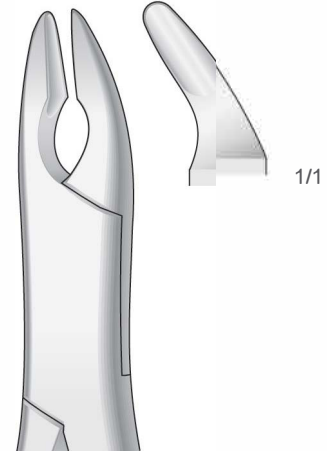

CRYER
WI-10070
 Fig. 150A

Obere Prämolaren, Schneidezähne, Wurzeln
 Upper Bicuspids, incisors and roots
 Premolari, incisivi e radici superiori
 Premolares, incisivos y raíces superiores
 Prémolaires, incisives et racines supérieures

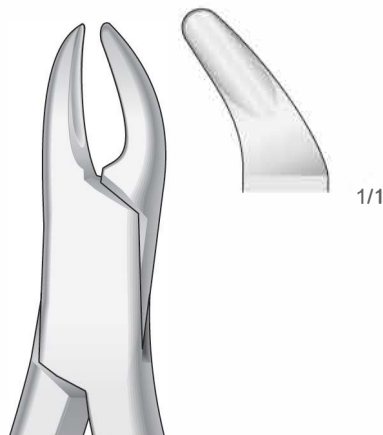

wi-10071
 Fig. 62

Schneidezähne, Prämolaren, Milchzähne
 Incisors, premolars, deciduous teeth
 Incisivi, premolari, denti da latte
 Incisivos, premolares, dientes de leche
 Incisives, prémolaires, dents de lait



Zahnzangen, Amerikanische Form
 Extracting Forceps, American Pattern
 Pinze per estrazione, Forma Americana
 Pinzas da extracción, Forma Americana
 Daviers, Forme Américaine



WI-10076
 Fig. 53R

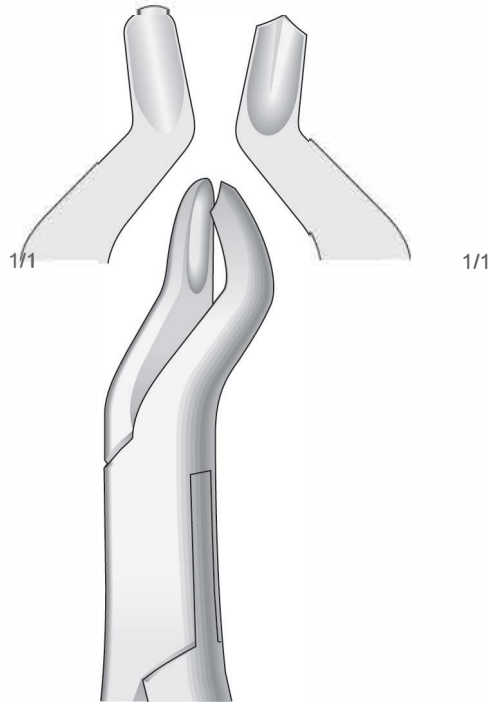

WI-10073
 Fig. 53L

Obere Molaren, Links
 Upper Molars, Left
 Molari superiori, Sinistra
 Molares superiores, Izquierdos
 Molaires supérieures, Gauches

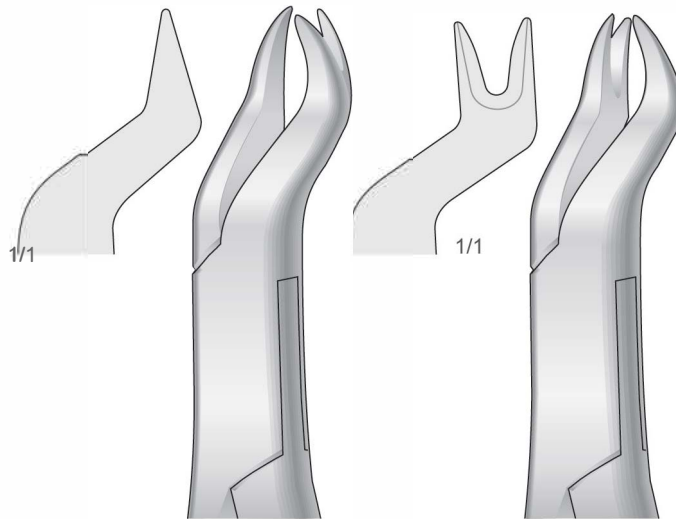

NEVIUS
WI-10074
 Fig. 88R

Obere Molaren, Rechts
 Upper Molars, Right
 Molari superiori, Destra
 Molares superiores, Derechos
 Molaires supérieures, Droites

NEVIUS
WI-10075
 Fig. 88L

Obere Molaren, Links
 Upper Molars, Left
 Molari superiori, Sinistra
 Molares superiores, Izquierdos
 Molaires supérieures, Gauches



Zahnzangen, Amerikanische Form
 Extracting Forceps, American Pattern
 Pinze per estrazione, Forma Americana
 Pinzas da extracción, Forma Americana
 Daviers, Forme Américaine

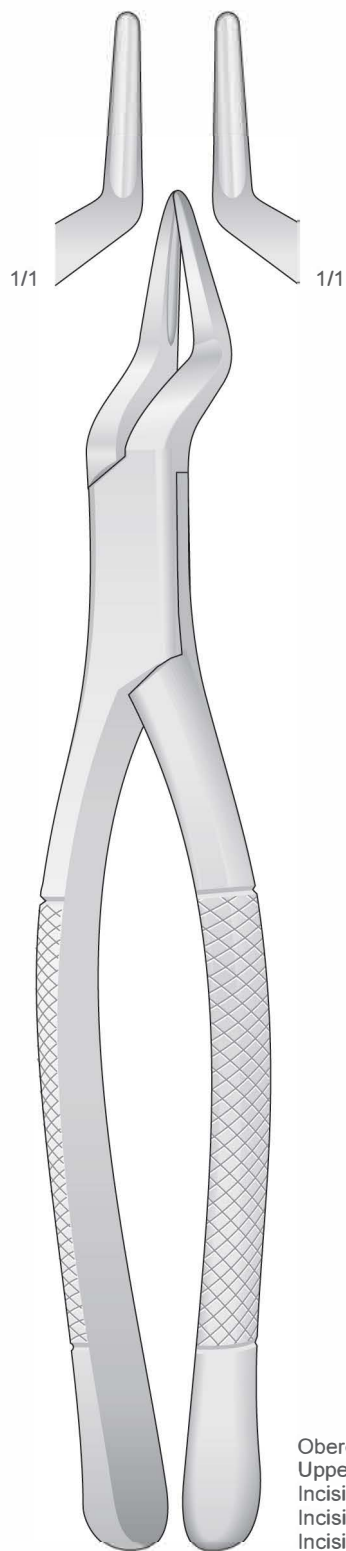

WI-10079
 Fig.65

Obere Schneidezähne und Wurzeln
 Upper Incisors and Roots
 Incisivi e radici superiori
 Incisivos y raíces superiores
 Incisives et racines supérieures

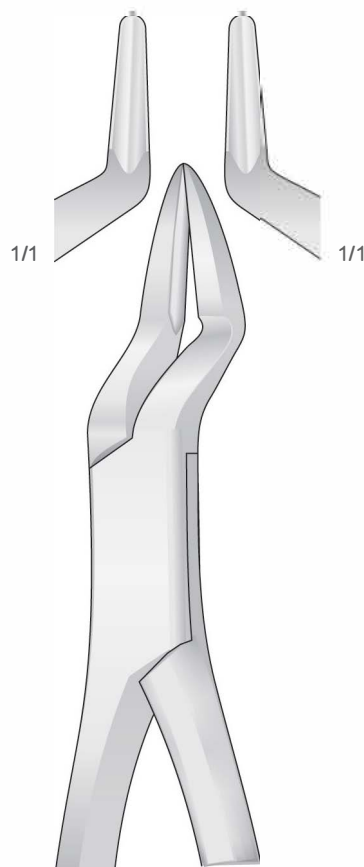

PARMLY
WI-10077
 Fig. 32A

Obere Wurzeln und Prämolaren
 Upper Roots and Premolars
 Radici e premolari superiori
 Raices y premolares superiores
 Racines et prémolaires supérieures

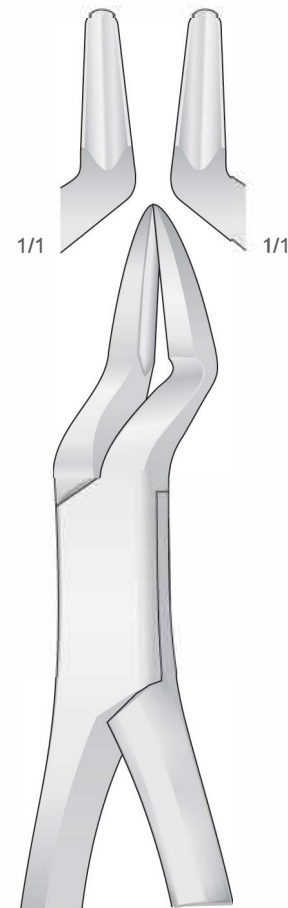

PARMLY
WI-10078
 Fig. 32

Obere Prämolaren und Molaren
 Upper Premolars and Molars
 Premolari e molari superiori
 Premolares y Molares superiores
 Prémolaires et Molaires supérieures



Zahnzangen, Amerikanische Form
 Extracting Forceps, American Pattern
 Pinze per estrazione, Forma Americana
 Pinzas da extracción, Forma Americana
 Daviers, Forme Américaine

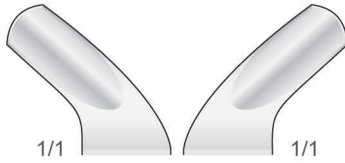
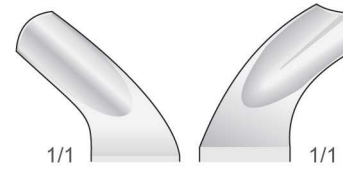
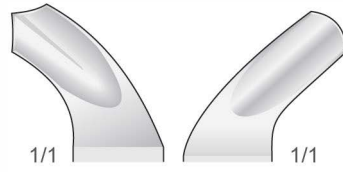

HARRIS
WI-10080
 Fig. 18R

Obere Molaren, Rechts
 Upper Molars, Right
 Molari superiori, Destra
 Molares superiores, Derechos
 Molaires supérieures, Droites

HARRIS
WI-10081
 Fig. 18L

Obere Molaren, Links
 Upper Molars, Left
 Molari superiori, Sinistra
 Molares superiores, Isquierdos
 Molaires supérieures, Gauches



WI-10082
 Fig. 24

Obere Molaren
 Upper Molars
 Molari superiori
 Molares superiores
 Molaires supérieures

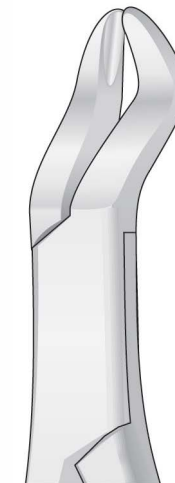

WI-10083
 Fig. 210

Obere Molaren
 Upper Molars
 Molari superiori
 Molares superiores
 Molaires supérieures



Zahnzangen, Amerikanische Form
 Extracting Forceps, American Pattern
 Pinze per estrazione, Forma Americana
 Pinzas da extracción, Forma Americana
 Daviers, Forme Américaine

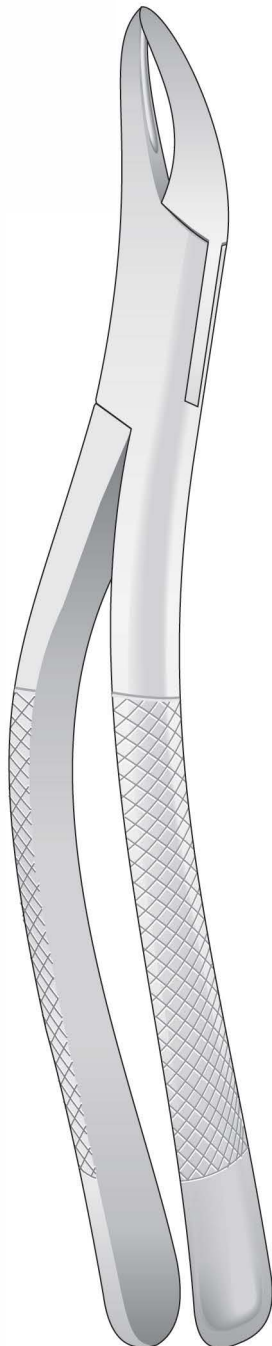
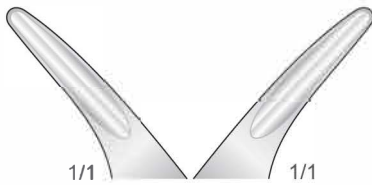

TOMES
WI-10084
 Fig.69

Obere und Untere
 Upper and lower
 Superiori e inferiori
 Superiores y inferiores
 Supérieures et inférieures

Wurzeln
 Roots
 Radici
 Raíces
 Racines

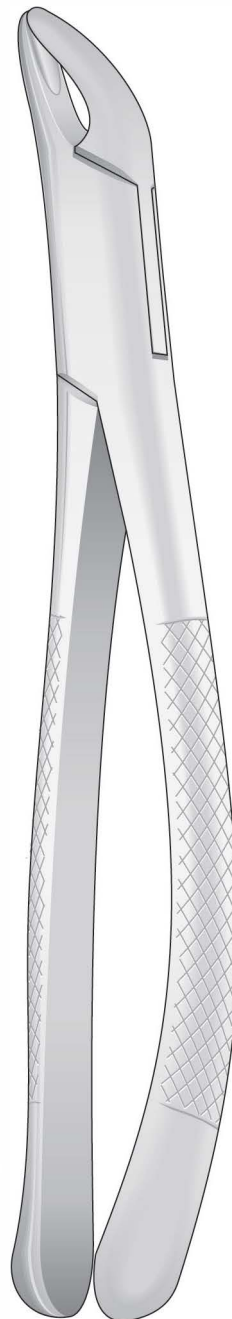
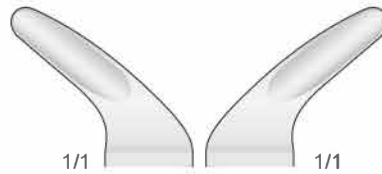

CRYER
WI-10085
 Fig.151

Untere
 Lower
 Inferiori
 Inferiores
 Inférieures

Schneidezähne, Prämolaren, Wurzeln
 Incisors, Premolars, Roots
 Incisivi, premolari, radici
 Incisivos, premolares, raíces
 Incisives, prémolaires, racines

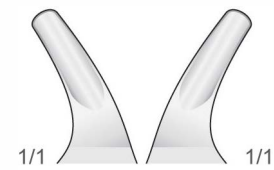

HULL
WI-10086
 Fig. 101

Für Eckzähne und Prämolaren,
 Universalzange und Kinderzange
 For canines and Premolars,
 Universal and Tooth forceps for children
 Canini e premolari,
 universale e per bambini
 Caninos y premolares,
 universal y para niños
 Canines et prémolaires,
 universel et pour enfants



Zahnzangen, Amerikanische Form
 Extracting Forceps, American Pattern
 Pinze per estrazione, Forma Americana
 Pinzas da extracción, Forma Americana
 Daviers, Forme Américaine

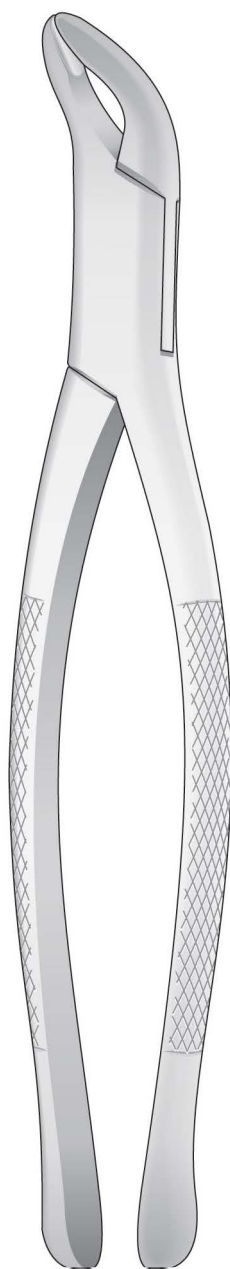
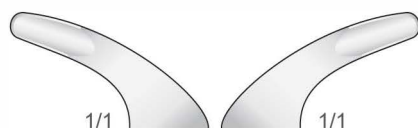

WI-10089
 Fig. 203

Untere Schneidezähne, Prämolaren, Wurzeln
 Lower Incisors, Premolars, Roots
 Incisivi, premolari, radici inferiori
 Incisivos, premolares, raices inferiores
 Incisives, prémolaires, racines inférieures

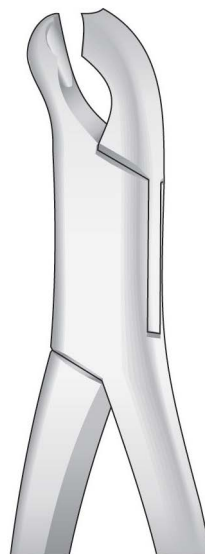
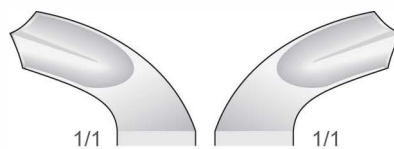

WI-10087
 Fig. 17

Untere Molaren
 Lower Molars
 Molari inferiori
 Molares inferiores
 Molaires inférieures

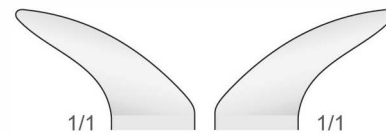

WI-10088
 Fig. 23

Untere Molaren
 Lower Molars
 Molari inferiori
 Molares inferiores
 Molaires inférieures



Zahnzangen, Amerikanische Form
 Extracting Forceps, American Pattern
 Pinze per estrazione, Forma Americana
 Pinzas da extracción, Forma Americana
 Daviers, Forme Américaine

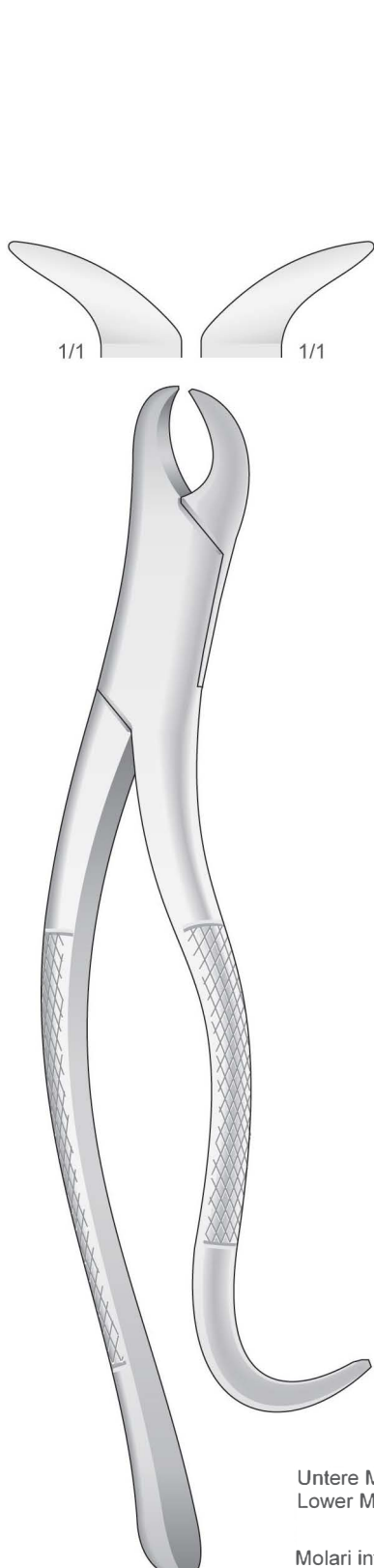

WI-10092

0
 Fig.
 16

Untere Molaren
 Lower Molars

Molari inferiori
 Molares inferiores
 Molaires inféneures

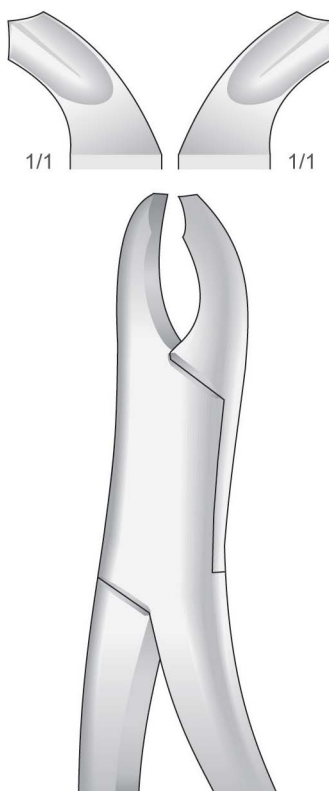

HARRIS
WI-1090

Fig
 Untere Molaren
 Lower Molars
 Molari inferiori

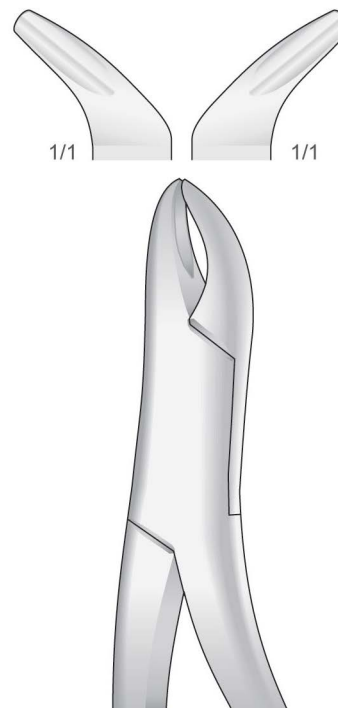

WI-10091
 Fig. 103



Zahnzangen, Amerikanische Form
 Extracting Forceps, American Pattern
 Pinze per estrazione, Forma Americana
 Pinzas da extracción, Forma Americana
 Daviers, Forme Américaine

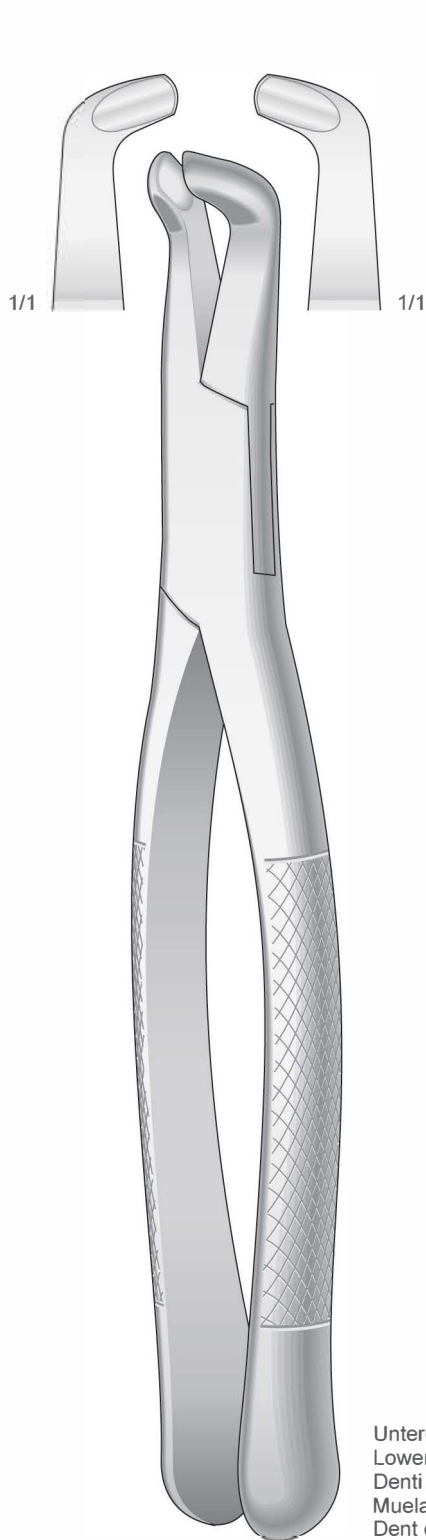

WI-10094
 Fig. 222

Untere Weisheitszähne
 Lower wisdom teeth
 Denti del giudizio inferiori
 Muelas del juicio inferiores
 Dent de sagesse inférieures

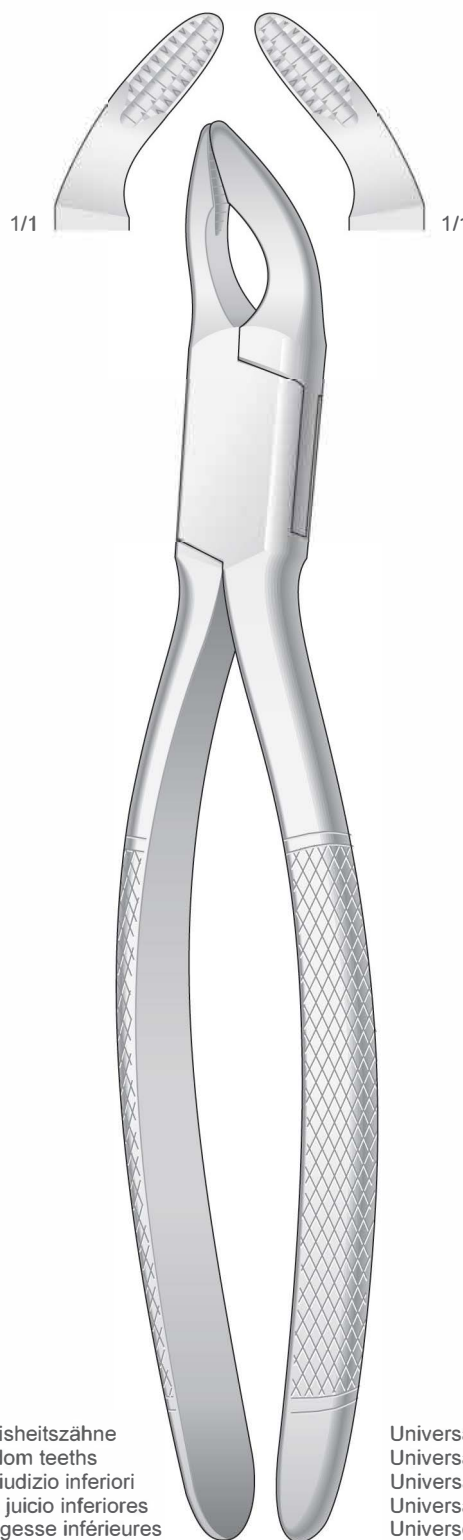

COHEN
WI-10095

Universal
 Universal
 Universale
 Universal
 Universel

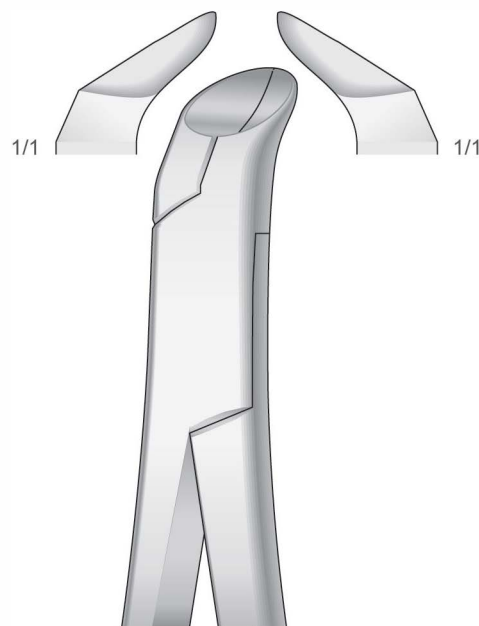

PHYSICK
WI-10093
 Fig. 5

Untere Weisheitszähne
 Lower wisdom teeth
 Denti del giudizio inferiori
 Muelas del juicio inferiores
 Dent de sagesse inférieures



Zahnzangen, Amerikanische Form
 Extracting Forceps, American Pattern
 Pinze per estrazione, Forma Americana
 Pinzas da extracción, Forma Americana
 Daviers, Forme Américaine

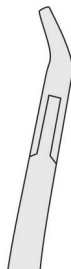
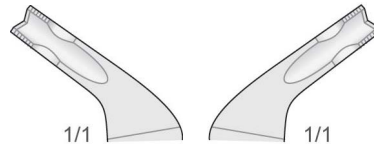
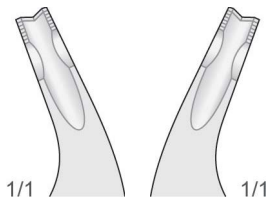

Obere
 Upper
 Superiori
 Superiores
 Supérieures

Prämolaren, Schneidezähne und Wurzeln
 Bicuspids, incisors and roots
 Premolari, incisivi e radici
 Premolares, incisivos y raíces
 Premolaires, incisives et racines

WI-10096
 Fig. 150AS



Untere
 Lower
 Inferiori
 Inferiores
 Inférieures

Prämolaren, Schneidezähne und Wurzeln
 Bicuspids, incisors and roots
 Premolari, incisivi e radici
 Premolares, incisivos y raíces
 Premolaires, incisives et racines

WI-10097
 Fig. 151AS



Zahnzangen, Amerikanische Form
 Extracting Forceps, American Pattern
 Pinze per estrazione, Forma Americana
 Pinzas da extracción, Forma Americana
 Daviers, Forme Américaine

Für Kinder
 For children
 Per bambini
 Para niños
 Pour enfants

Obere - Upper
 Superiori - Superiores
 Supérieures

Untere - Lower
 Inferiori - Inferiores
 Inférieures

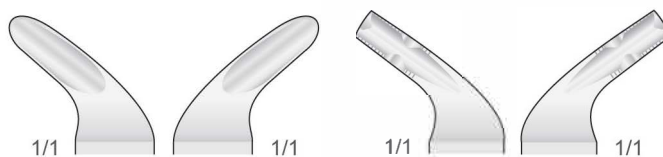
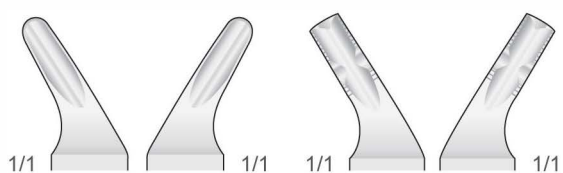

CRYER
WI-10098
 Fig.150 S

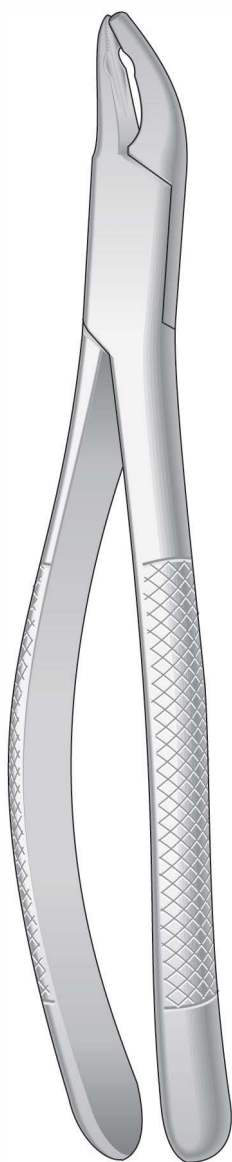

WI-10099
 Fig.150 XAS

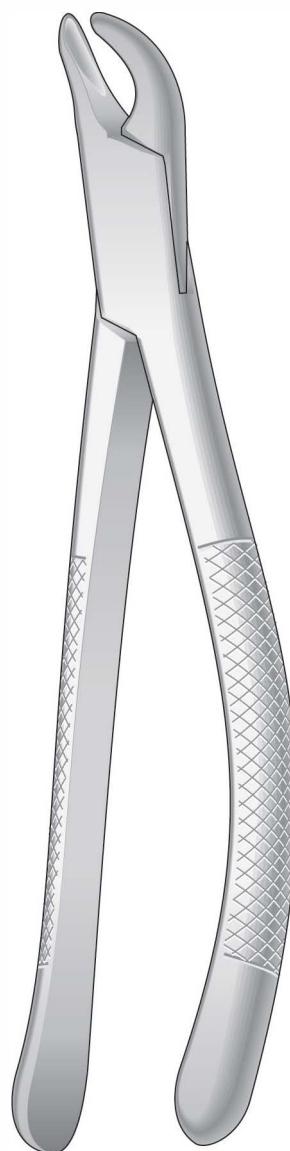

CRYER
WI-10100
 Fig.151 S

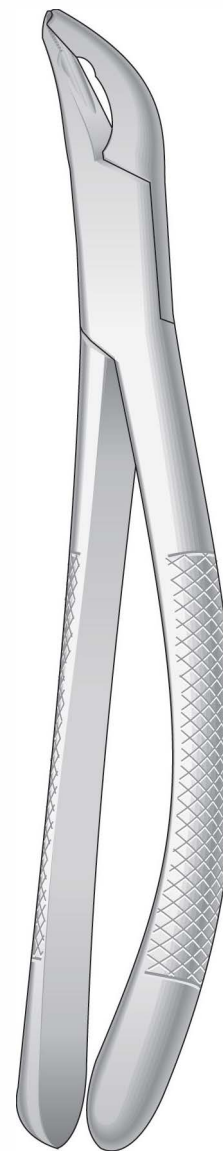

WI-10101
 Fig.151 XAS



Zahnzangen, Amerikanische Form
 Extracting Forceps, American Pattern
 Pinze per estrazione, Forma Americana
 Pinzas da extracción, Forma Americana
 Daviers, Forme Américaine

Geriefte - Serrated - Striata - Estriadas - Striées

Obere Schneidezähne, Prämolaren, Wurzeln
 Upper incisors, premolars, roots
 Incisivi, premolari e radici superiori
 Incisivos, premolares y raíces superiores
 Incisives, premolaires et racines supérieures

Untere Schneidezähne, Prämolaren, Wurzeln
 Lower incisors, premolars, roots
 Incisivi, premolari e radici inferiori
 Incisivos, premolares y raíces inferiores
 Incisives, premolaires et racines inférieures

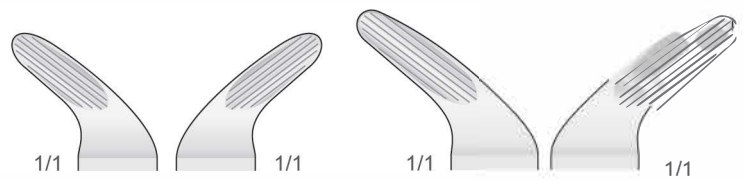
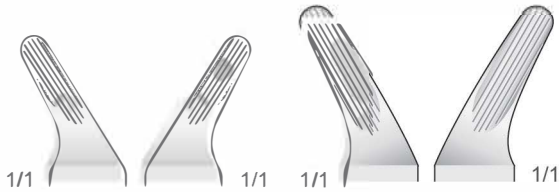

CRYER
WI-10102
 Fig. 150

Für Erwachsene
 For adults
 Per adulti
 Para adultos
 Pour adults

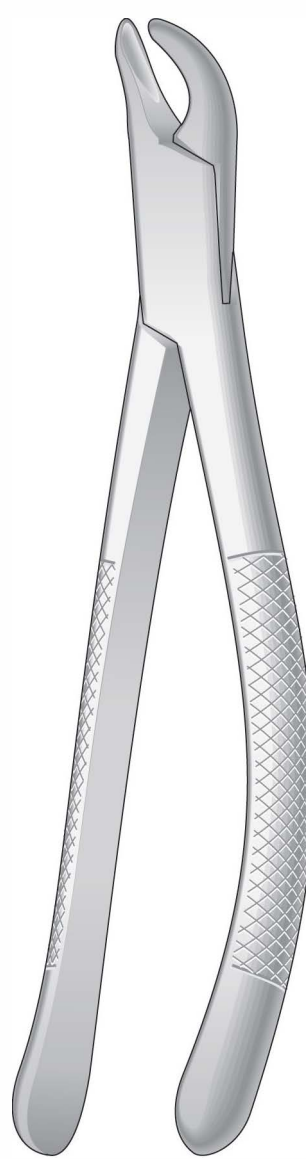

CRYER
WI-10103
 Fig. 151

Für Erwachsene
 For adults
 Per adulti
 Para adultos
 Pour adults

CRYER
wi-10104
 Fig.150 S

Für Kinder
 For children
 Per bambini
 Para niños
 Pour enfants

CRYER
WI-10105
 Fig.151 S

Für Kinder
 For children
 Per bambini
 Para niños
 Pour enfants



Zahnzangen
 Extracting Forceps
 Pinze per estrazione
 Pinzas da extracción
 Daviers

Schneidezähne, Eckzähne, Wurzeln
 Incisors, bicuspid and roots
 Incisivi, canini e radici
 Incisivos, caninos y raíces
 Incisives, canines et racines

Molaren
 Molars
 Molari
 Molares
 Molaïres

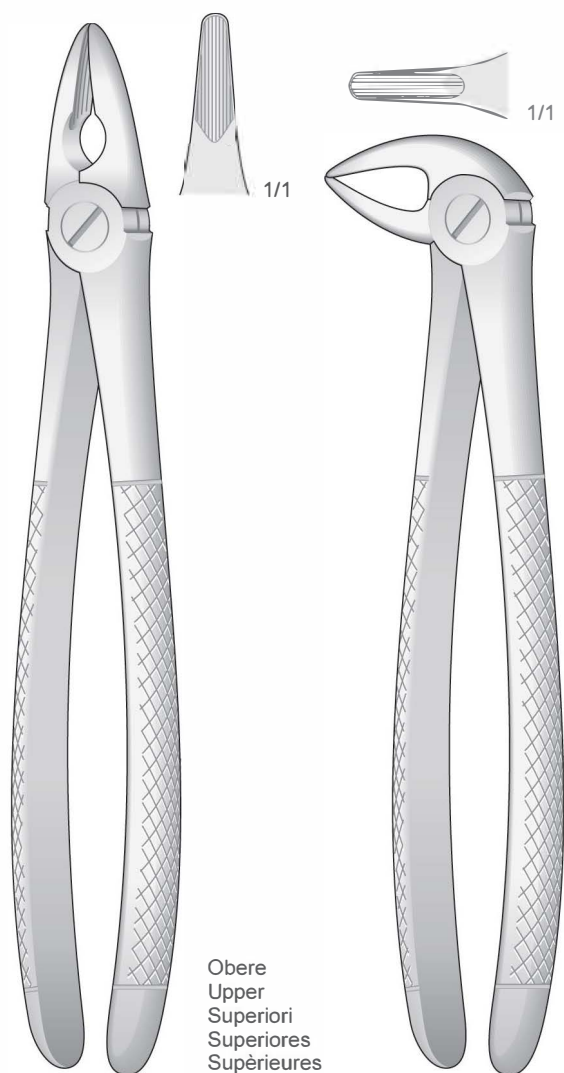

Obere
 Upper
 Superiori
 Superiores
 Supérieures

Untere
 Lower
 Inferiori
 Inferiores
 Inférieures

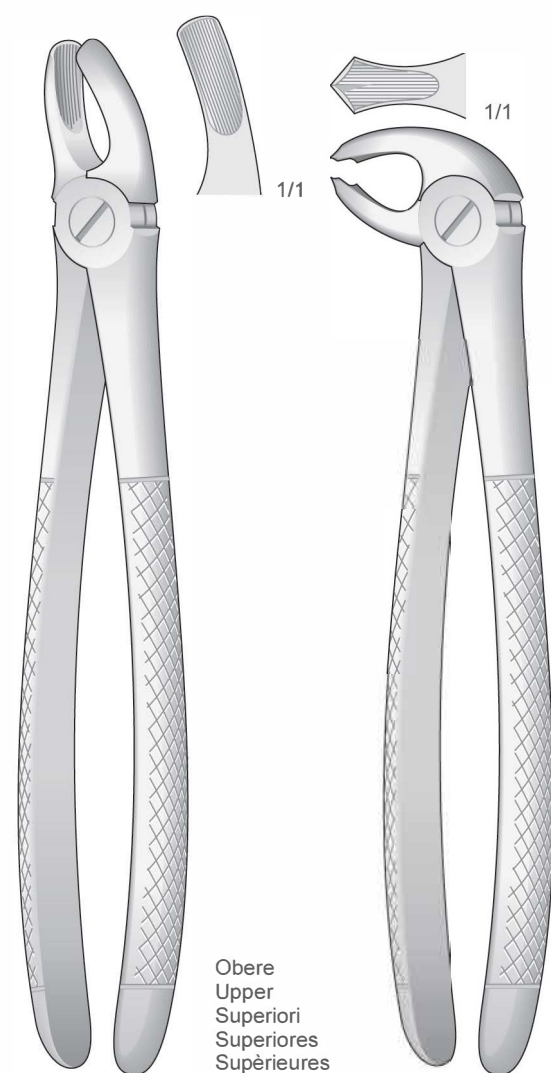

Obere
 Upper
 Superiori
 Superiores
 Supérieures

Untere
 Lower
 Inferiori
 Inferiores
 Inférieures

WI-10106
 MD-1

WI-10107
 MD-3

WI-10108
 MD-2

WI-10109
 MD-4



Kinderzahnzangen, Amerikanische Form
 Extracting Forceps for children, American Pattern
 Pinze per estrazione per bambini, Forma Americana
 Forceps dentales para niños, Forma Americana
 Daviers pour enfants, Forme Américaine

Molaren
 Pedo Lower Molars
 Molari
 Molares
 Molaires

Molaren
 Pedo Lower Molars
 Molari
 Molares
 Molaires

Zähne und wurzeln
 Pedo upper incisors
 Bicuspids and roots
 Denti e radici
 Dientes y raices
 Dentes et racines

Zähne und wurzeln
 Pedo lower incisors
 Bicuspids and roots
 Denti e radici
 Dientes y raices
 Dentes et racines

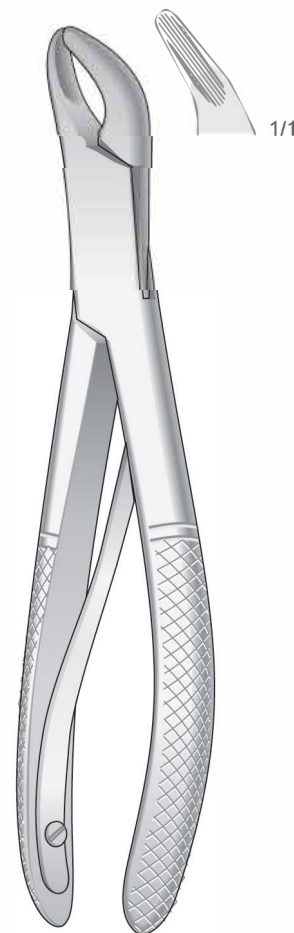
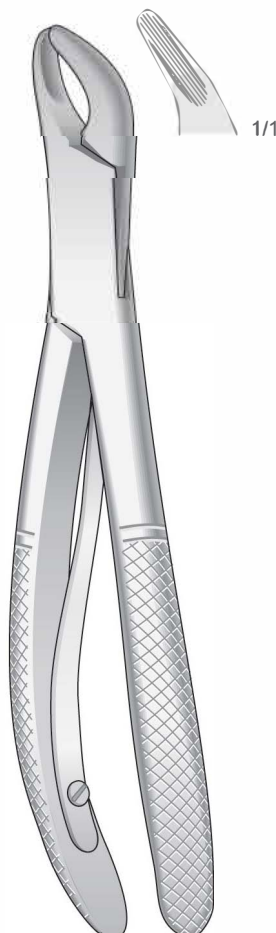
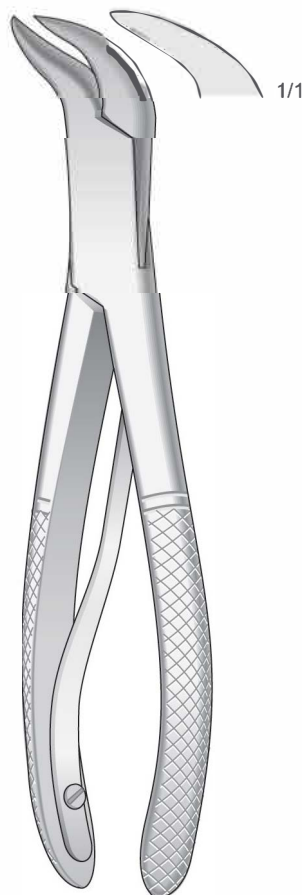
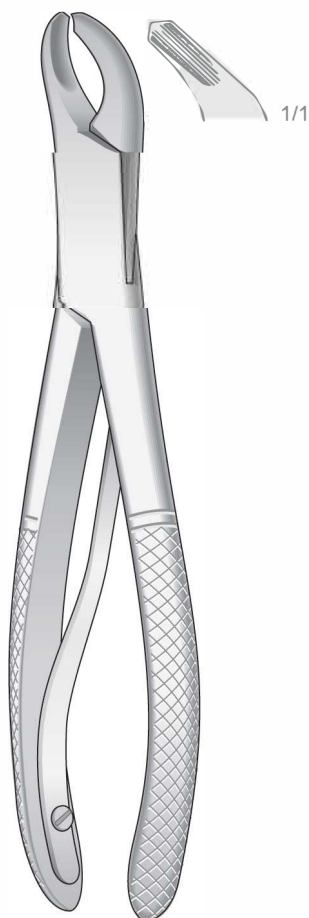

WI-10110
 Fig. 17SK

WI-10111
 Fig. 23SK

WI-10112
 Fig. 150SK

WI-10113
 Fig. 151SK



Kinderzahnzangen
 Extracting Forceps for children
 Pinze per estrazione per bambini
 Forceps dentales para niños
 Daviers pour enfants

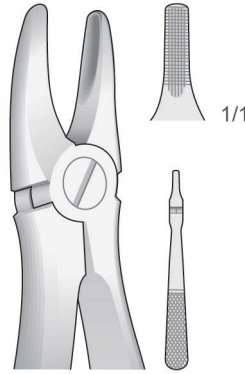

WI-10114A
 Fig. 137

Obere Schneidezähne
 Upper Incisors
 Incisivi superiori
 Incisivos superiores
 Incisives supérieures

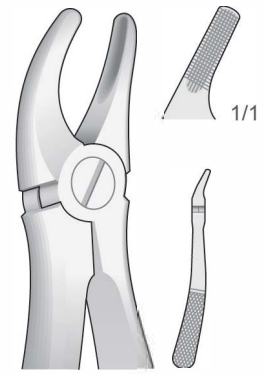

WI-10115
 Fig. 139

Obere Prämolaren
 Upper Premolars
 Premolari superiori
 Premolares superiores
 Prémolaires supérieures

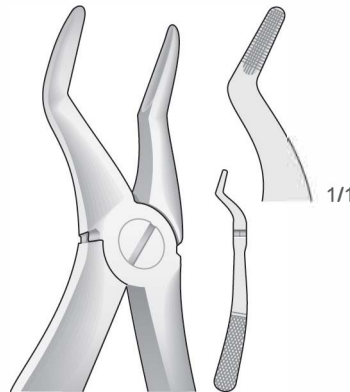

WI-10116
 Fig. 51S

Obere Wurzeln
 Upper roots
 Radici superiori
 Raíces superiores
 Racines supérieures

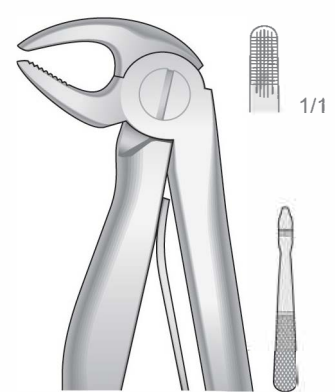

WI-10117
 Fig. 5

Untere Schneidezähne
 Lower incisors
 Incisivi inferiori
 Incisivos inferiores
 Incisives inférieures

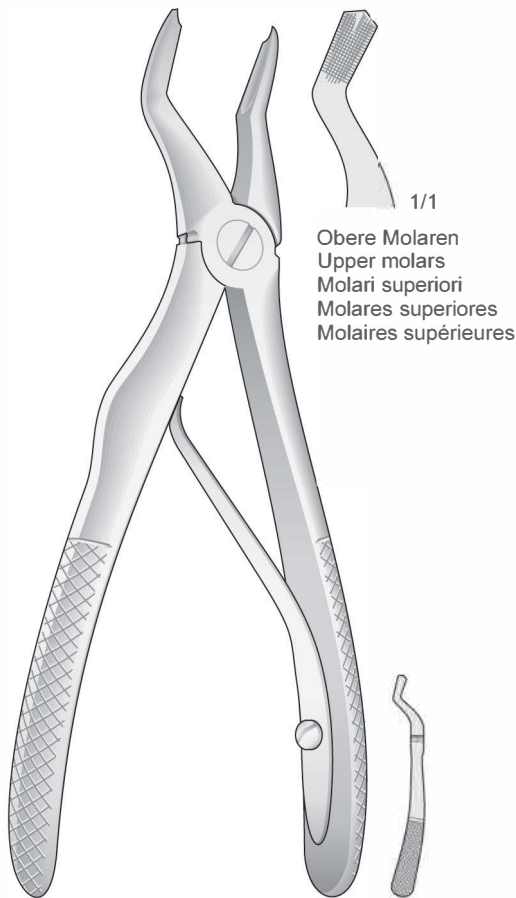

WI-10114
 PEB-3



WI-10118
 Fig. 6

Untere Molaren
 Lower molars
 Molari inferiori
 Molares inferiores
 Molaires inférieures

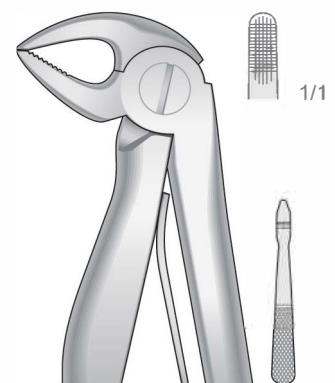

WI-10119
 Fig. 7

Untere Wurzeln
 Lower roots
 Radici inferiori
 Raíces inferiores
 Racines inférieures



Zahnzangen
 Extracting Forceps
 Pinzas per estrazione
 Pinzas da extracción
 Daviers

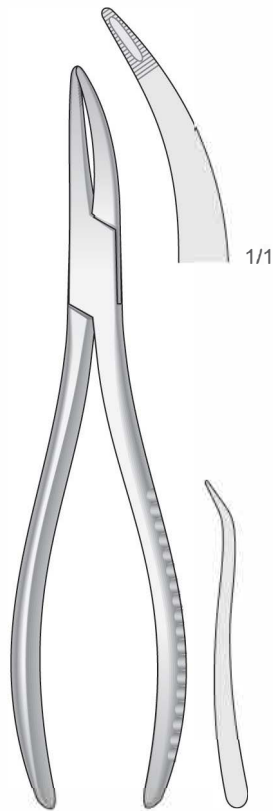

Obere Wurzeln, Universal
 Upper roots, Universal
 Radici superiori, Universale
 Raíces superiores, Universal
 Racines superieures, Universel

WITZEL
WI-10120
 170 mm

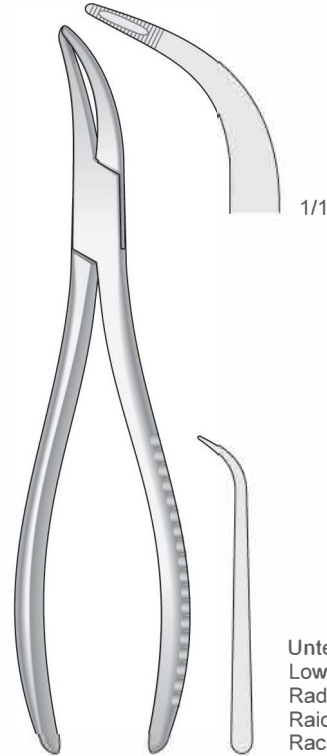

Untere Wurzeln, Universal
 Lower roots, Universal
 Radici inferiori, Universale
 Raíces inferiores, Universal
 Racines inferieures, Universel

WITZEL
wi-10121
 165 mm

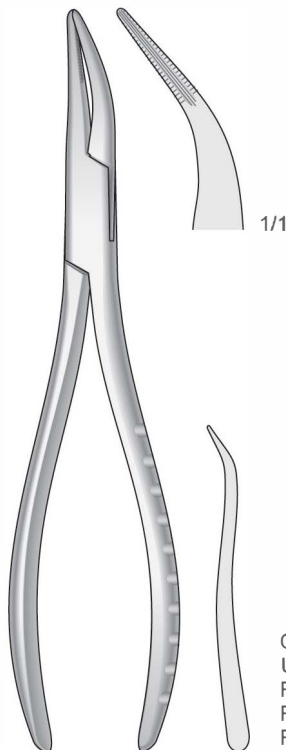

Obere Wurzeln, Universal
 Upper roots, Universal
 Radici superiori, Universale
 Raíces superiores, Universal
 Racines superieures, Universel

WI-10122
 165 mm

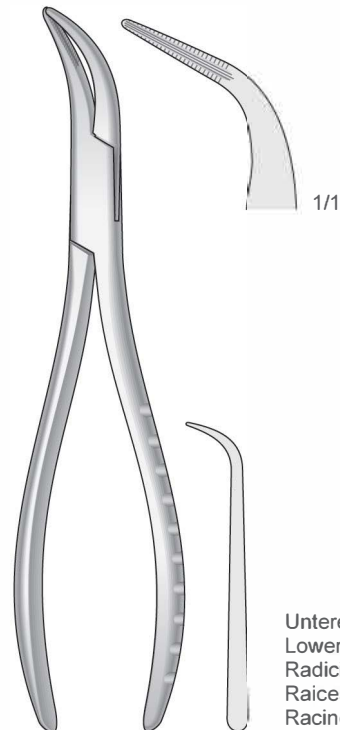

Untere Wurzeln, Universal
 Lower roots, Universal
 Radici inferiori, Universale
 Raíces inferiores, Universal
 Racines inferieures, Universel

WI-10123
 160 mm



Wurzelheber
 Root Elevators
 Leve per radici
 Elevadores para raíces
 Elevateurs à racines

SMALL HANDLE

Luxatoren - Luxators
 Lussatori - Luxadores
 Luxateurs

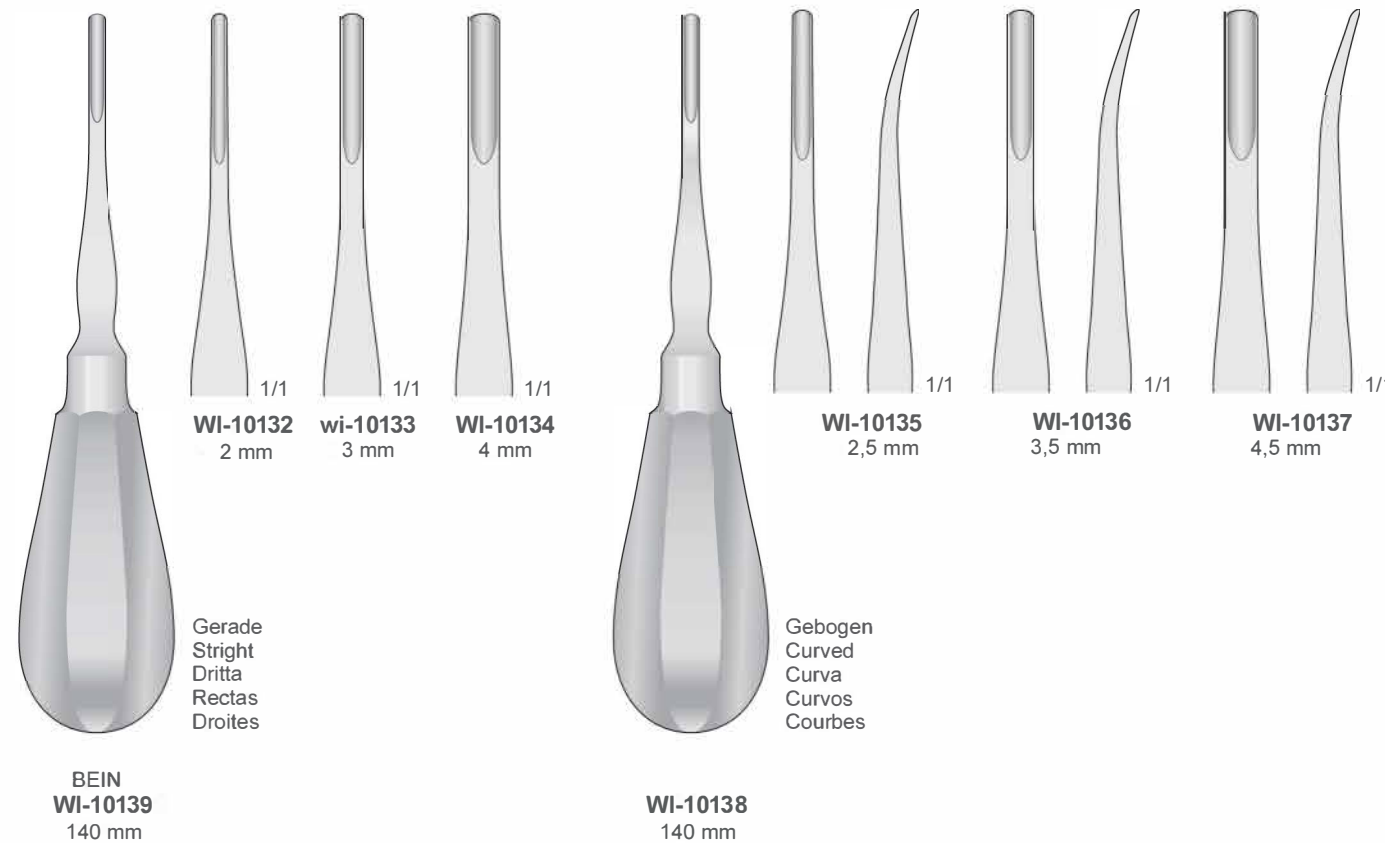
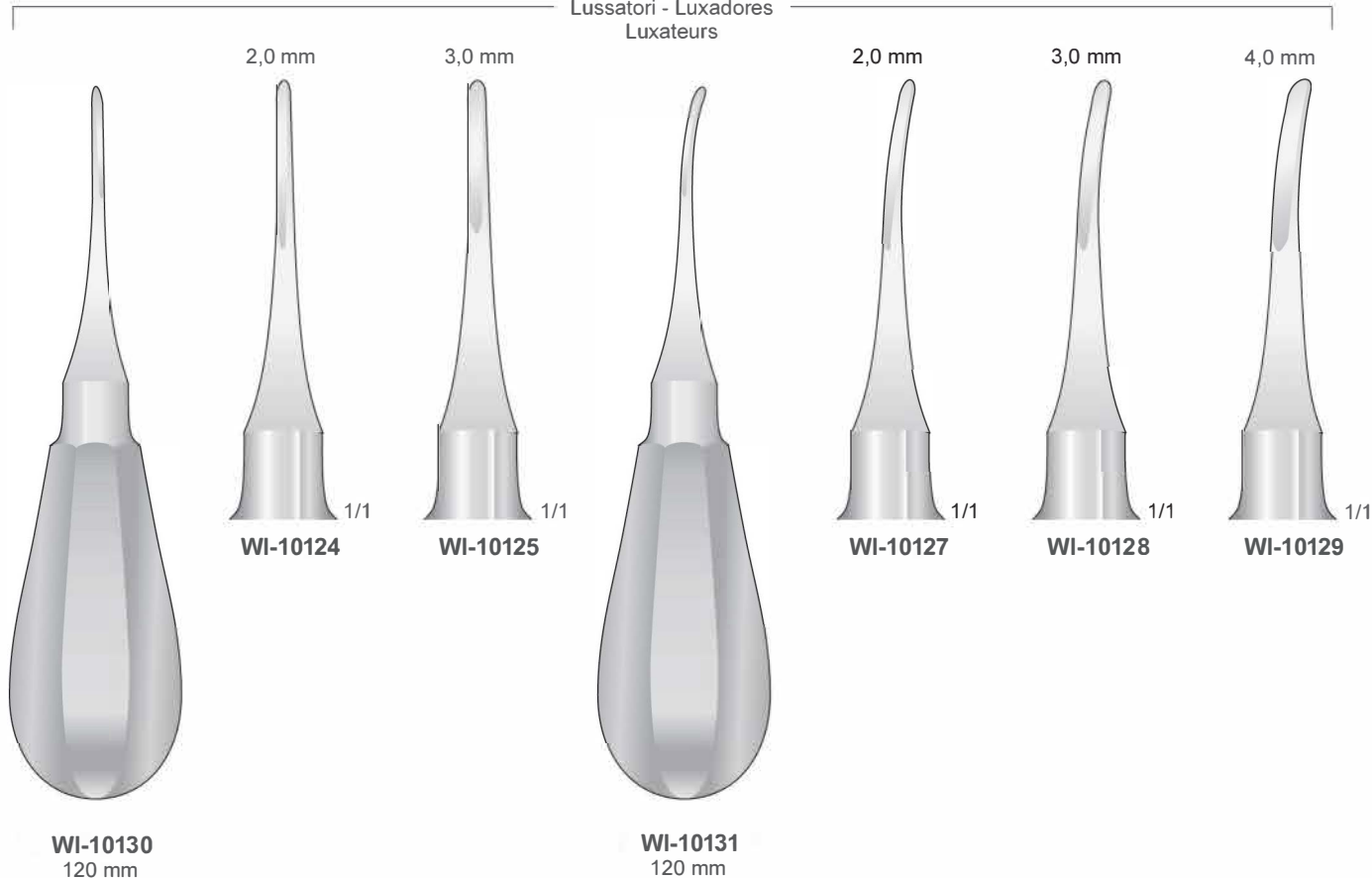



Wurzelheber
Root Elevators
Leve per radici
Elevadores para raíces
Elevateurs à racines

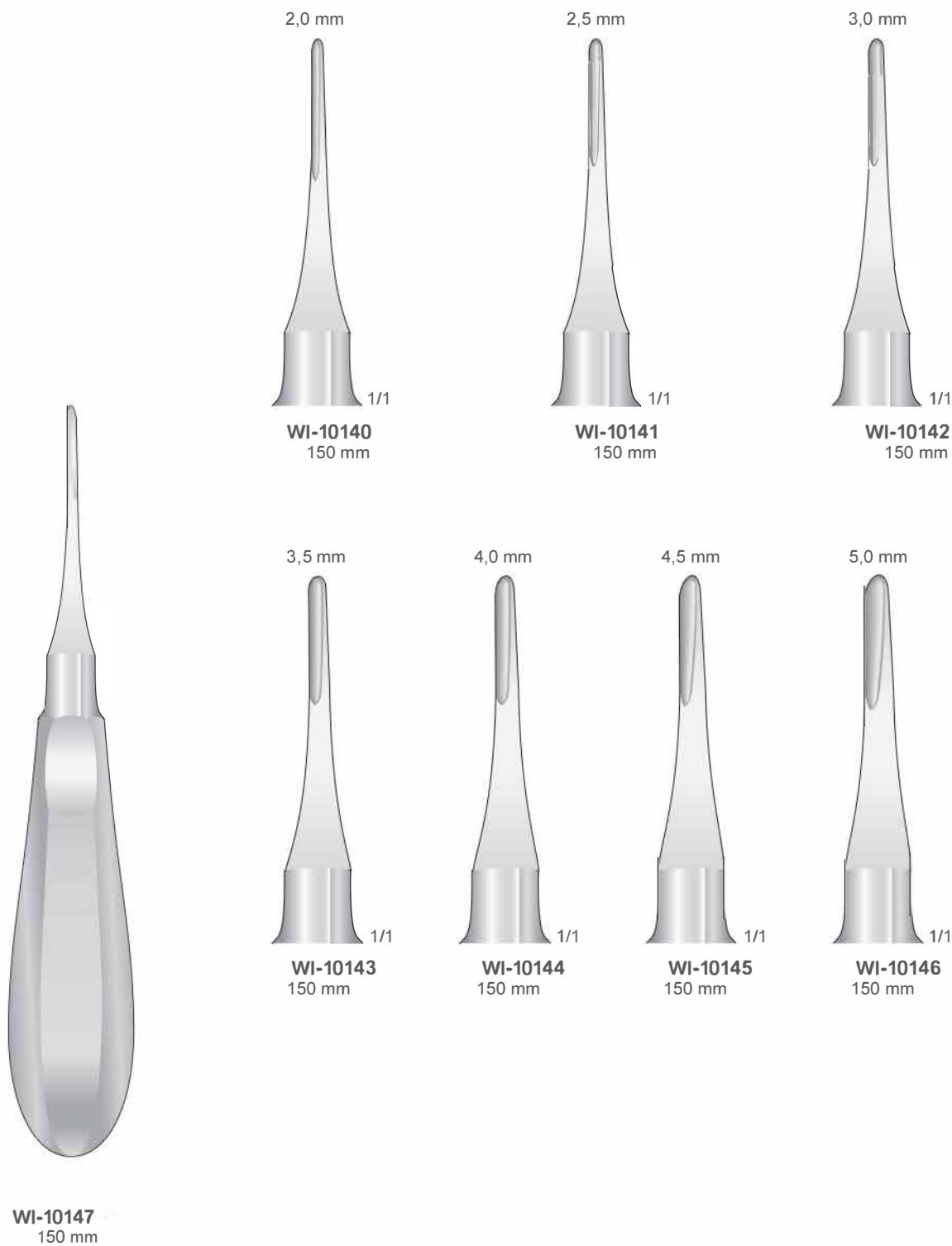



Wurzelheber
Root Elevators
Leve per radici
Elevadores para raíces
Elevateurs à racines

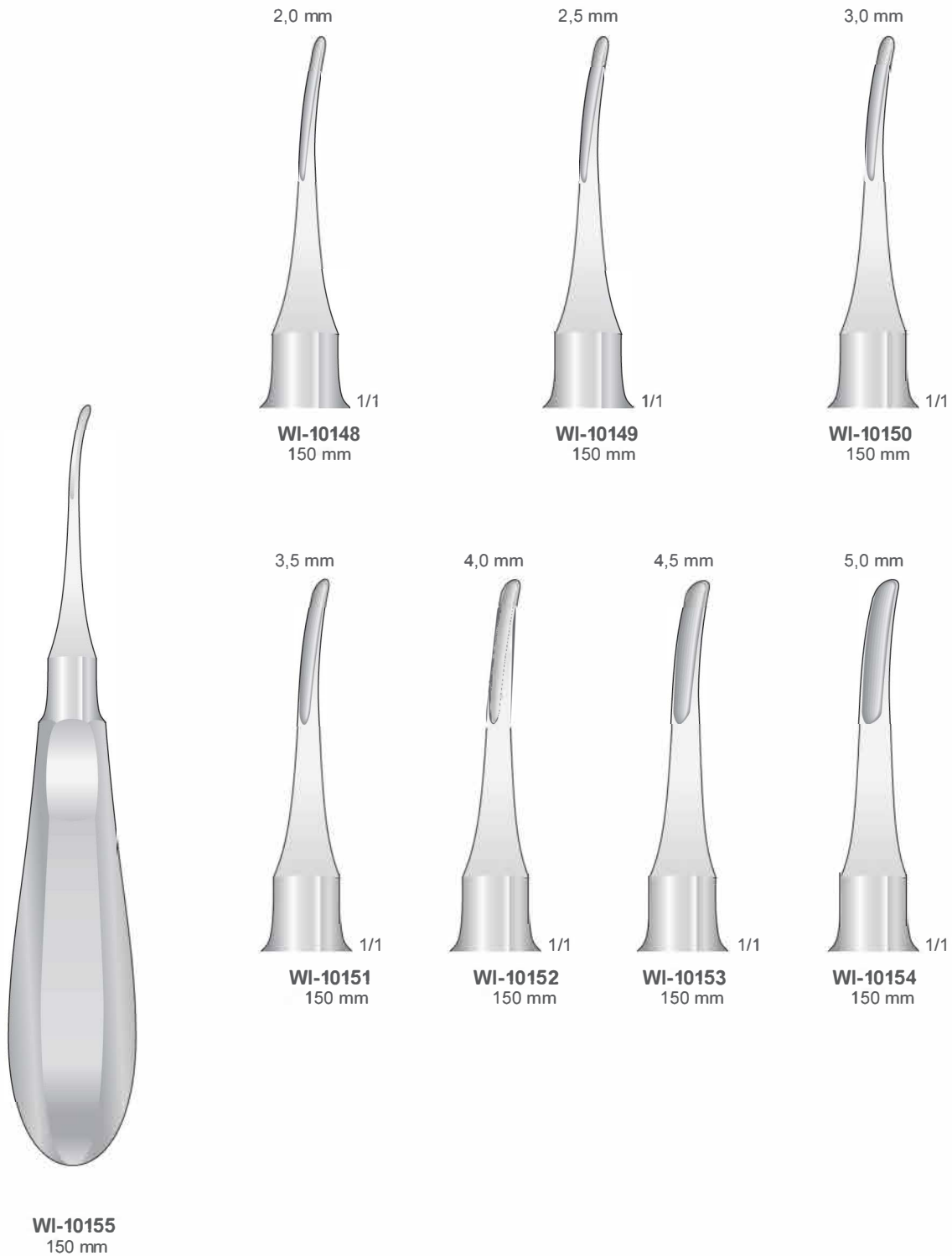



Wurzelheber
 Root Elevators
 Leve per radici
 Elevadores para raíces
 Elevateurs à racines

Luxatoren
 Luxators
 Lussatori
 Luxadores
 Luxateurs

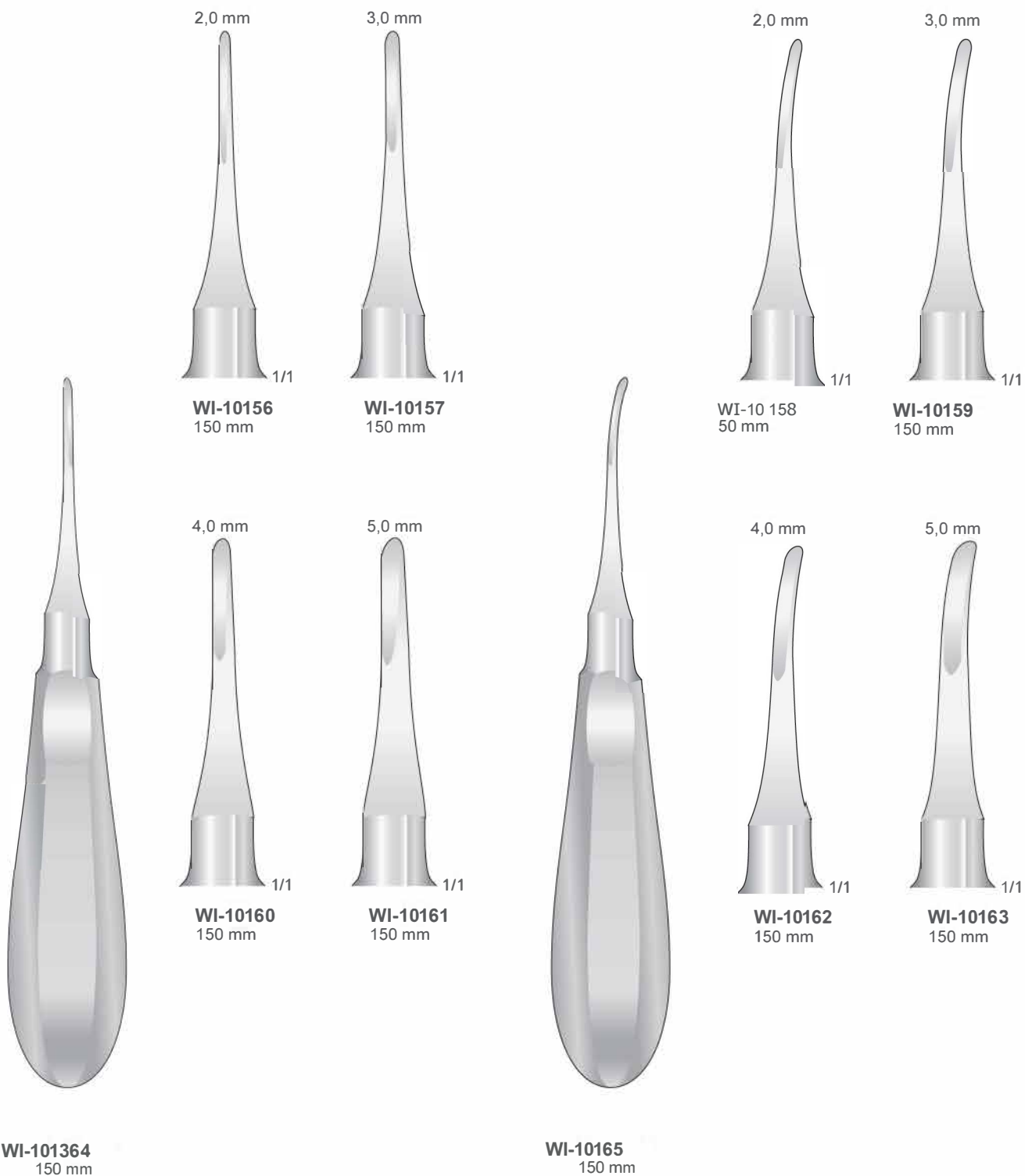



Wurzelheber
 Root Elevators
 Leve per radici
 Elevadores para raíces
 Elevateurs à racines

Wurzelspitzenheber
 Root fragment Elevators
 Leve per frammenti di radice
 Elevadores para fragmentos de raíces
 Elévateurs de fragments de racines

Gezahnt
 Serrated
 Dentellata
 Dentada
 Dentelé



HEIDBRINK
WI-10166
 140 mm



HEIDBRINK
WI-10167
 140 mm



HEIDBRINK
WI-10168
 140 mm

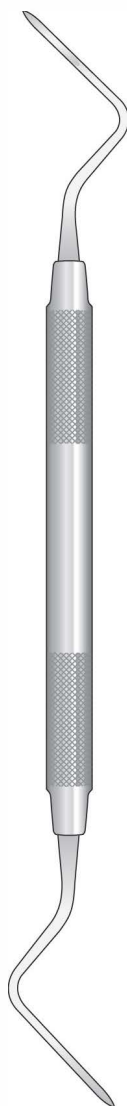

HEIDBRINK
WI-10169
 195 mm

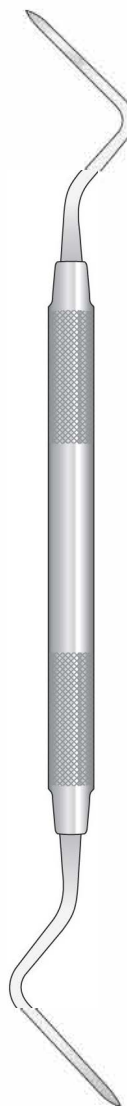

HEIDBRINK
WI-10170
 195 mm

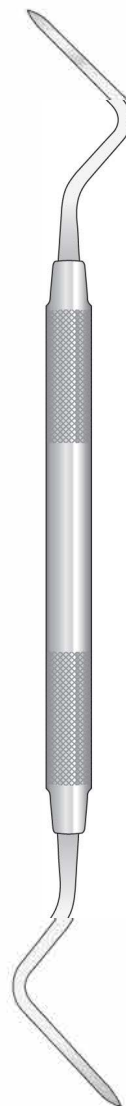

HEIDBRINK
WI-10171
 195 mm



HEIDBRINK
WI-10172
 195 mm



Wurzelheber
Root Elevators
Leve per radici
Elevadores para raíces
Elevateurs à racines

Extraktionshebel für obere Weisheitszähne
Luxator for upper wisdom teeth
Leva per estrazione dente del giudizio superiore
Elevador de extracción de muelas del juicio superiores
Lever d'extraction pour dent de sagesse supérieures

Wurzelheber
Root Elevators
Leve per radici
Elevadores para raíces
Elevateurs de racines



ROSIN
WI-10173
160 mm



WARWICK-JAMES
WI-10174
160 mm



WARWICK-JAMES
WI-10175
155 mm



WARWICK-JAMES
WI-10176
155 mm

Obere
Upper
Superiori
Superiores
Supérieures

Untere
Lower
Inferiori
Inferiores
Inférieures

Untere
Lower
Inferiori
Inferiores
Inférieures



Wurzelheber
 Root Elevators
 Leve per radici
 Elevadores para raíces
 Elevateurs à racines

Eine seite gezahnt
 One side serrated
 Un lato dentellato
 Dentadura mäs lado
 Dentelure sur un côté



Fig. 94



WI-10176A
155 mm

Fig. 95



WI-10177
155 mm

Fig. 100L



WI-10178
155 mm

Fig. 100R



WI-10179
155 mm



Wurzelheber
 Root Elevators
 Leve per radici
 Elevadores para raíces
 Elevateurs à racines

Gezahnt
 Serrated
 Dentellate
 Dentadas
 Dentelé



Fig. 301



APEXO
WI-10184
 160 mm

Fig. 302



APEXO
WI-10185
 160 mm

Fig. 303

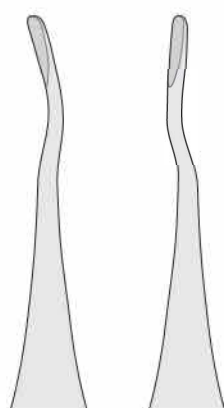

WI-10180

WI-10181

Fig. 77L



APEXO
WI-10186
 160 mm

Fig. 77R

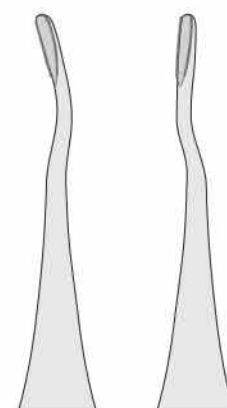

WI-10182

WI-10183



Wurzelheber
Root Elevators
Leve per radici
Elevadores para raíces
Elevateurs à racines

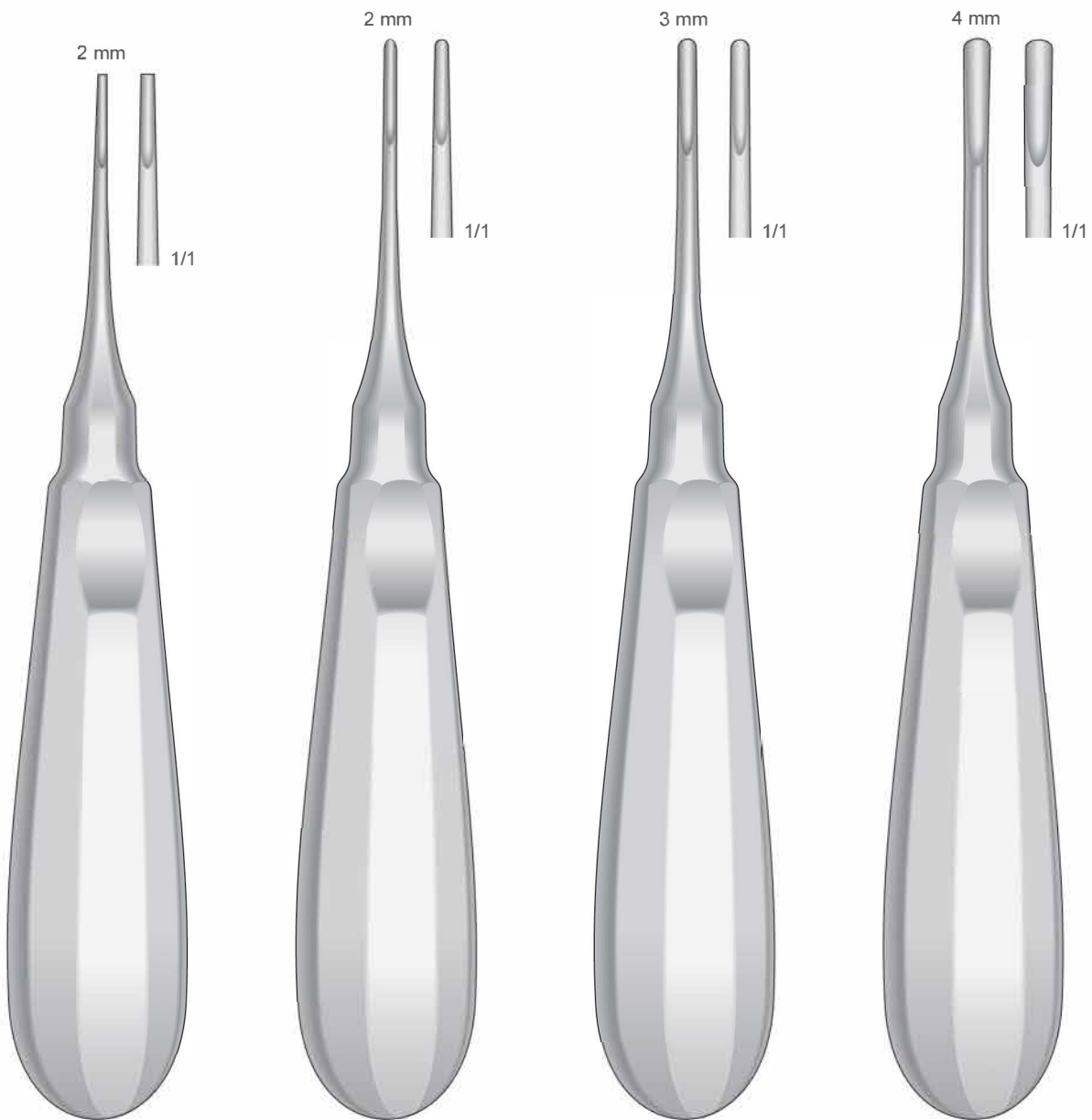

WI-10187
150 mm

WI-10188
155 mm

WI-10189
155 mm

WI-10190
155 mm



Wurzelheber
Root Elevators
Leve per radici
Elevadores para raíces
Elevateurs à racines

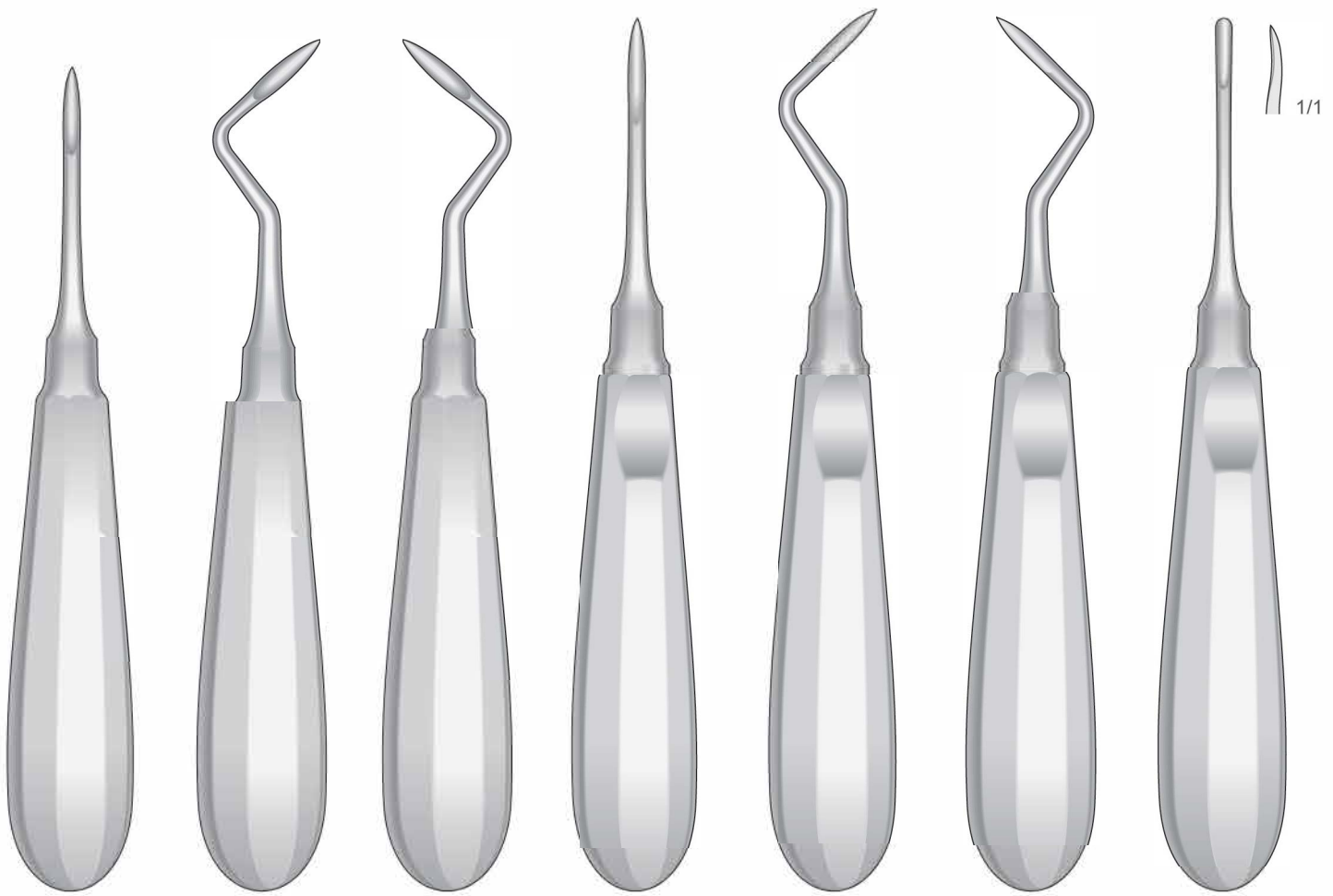

WI-10191
140 mm

WI-10192
150 mm

WI-10193
150 mm

WI-10194
155 mm

WI-10195
155 mm

WI-10196
155 mm

WI-10197
155 mm



Wurzelheber
 Root Elevators
 Leve per radici
 Elevadores para raíces
 Elevateurs à racines

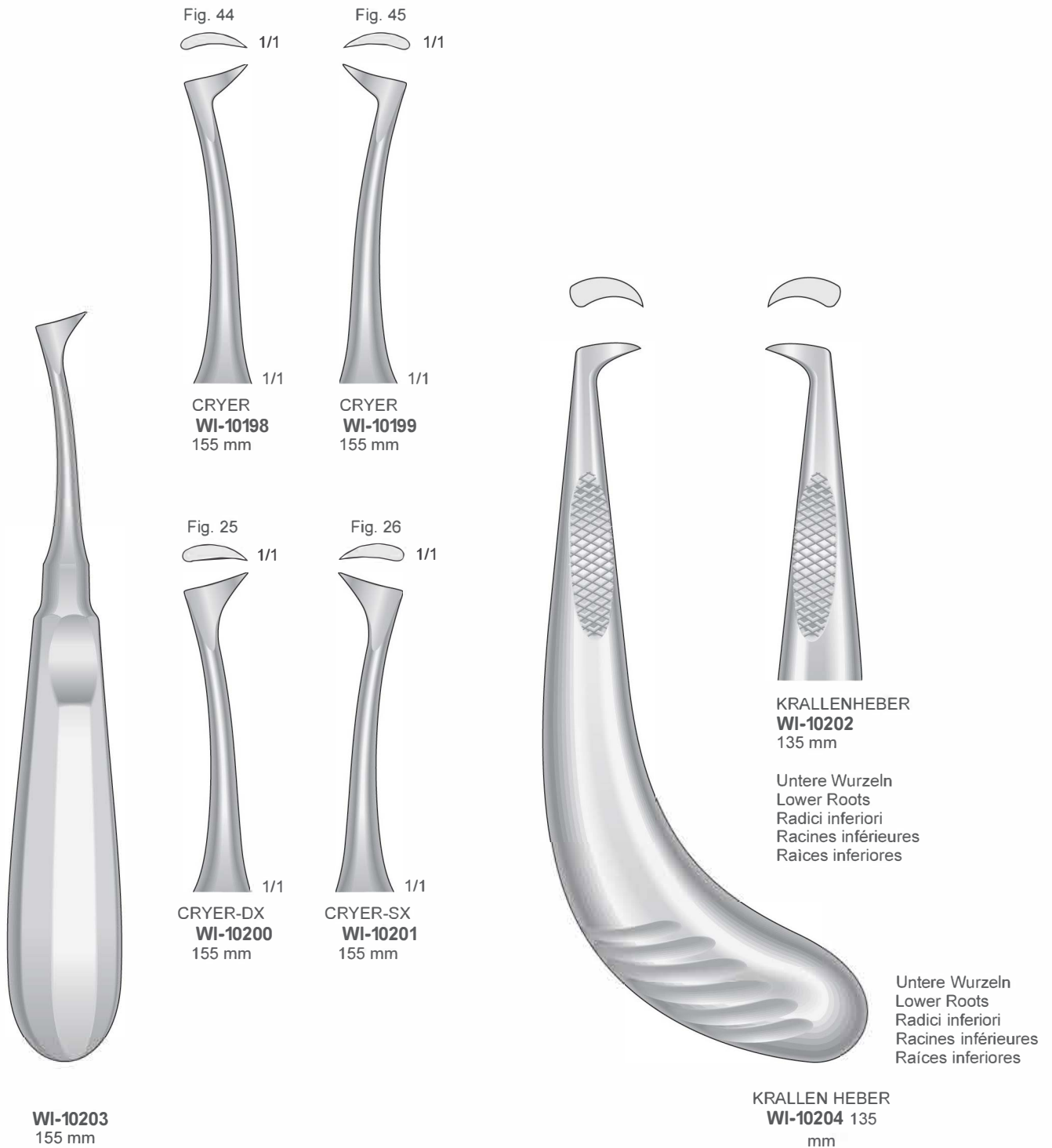



Wurzelheber
Root Elevators
Leve per radici
Elevadores para raíces
Elevateurs à racines



WI-10205
Large
160 mm
Angled IN

WI-10206
Large
160 mm
Angled OUT

WI-10207
Small
160 mm
Angled IN

WI-10208
Small
160 mm
Angled OUT

WI-10209
Straight
160 mm

WI-10210
Bayonet
160 mm

WI-10211
Curved
160 mm

Fig. 1
2,0 mm

Fig. 2
3,6 mm

Fig. 3
4,2 mm

Fig. 1
3,0 mm

Fig. 2
3,6 mm

Fig. 3
4,2 mm

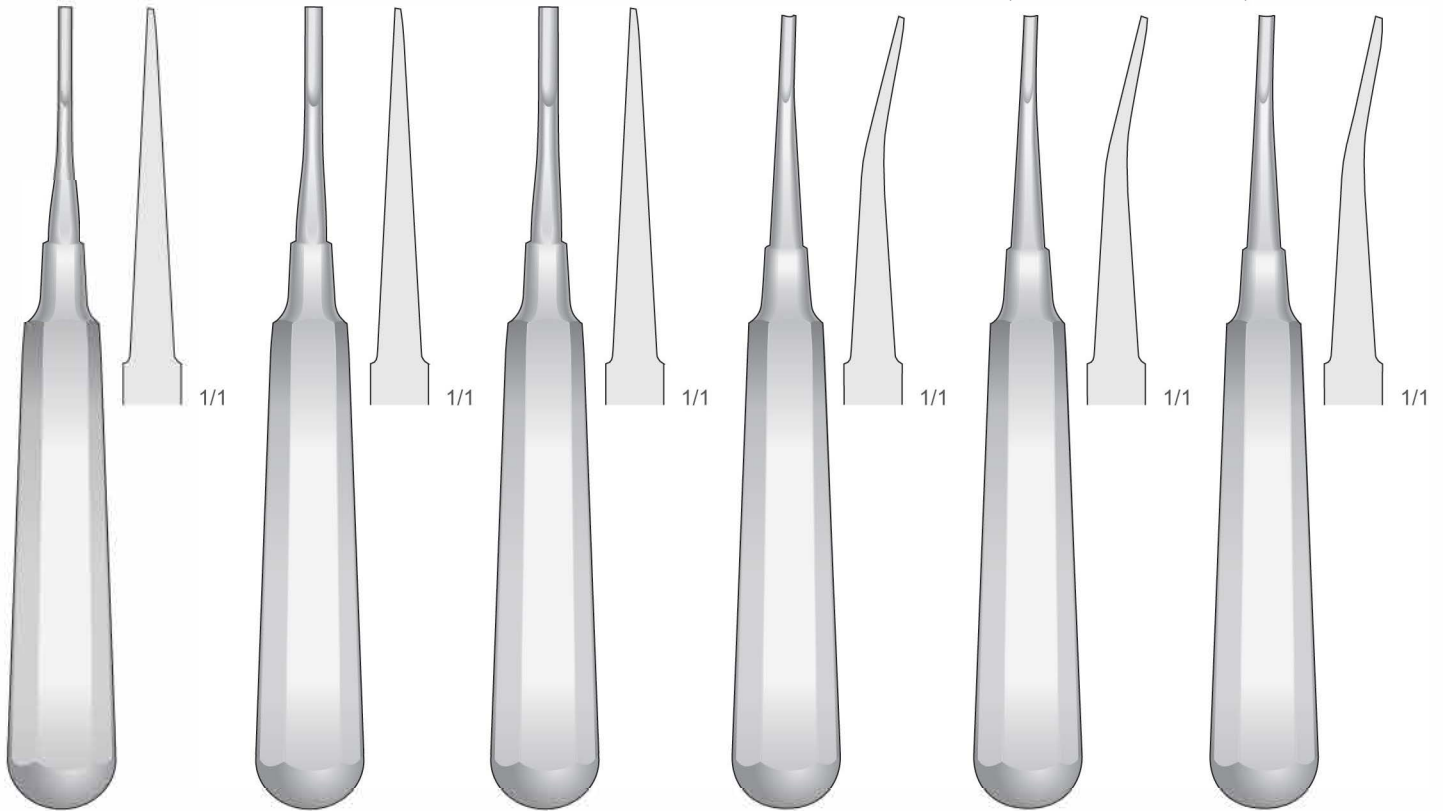

COUPLAND
WI-10212
155 mm

COUPLAND
WI-10213
155 mm

COUPLAND
WI-10214
155 mm

COUPLAND
WI-10215
155 mm

COUPLAND
WI-10216
155 mm

COUPLAND
WI-10217
155 mm



Wurzelheber
Root Elevators
Leve per radici
Elevadores para raíces
Elevateurs à racines

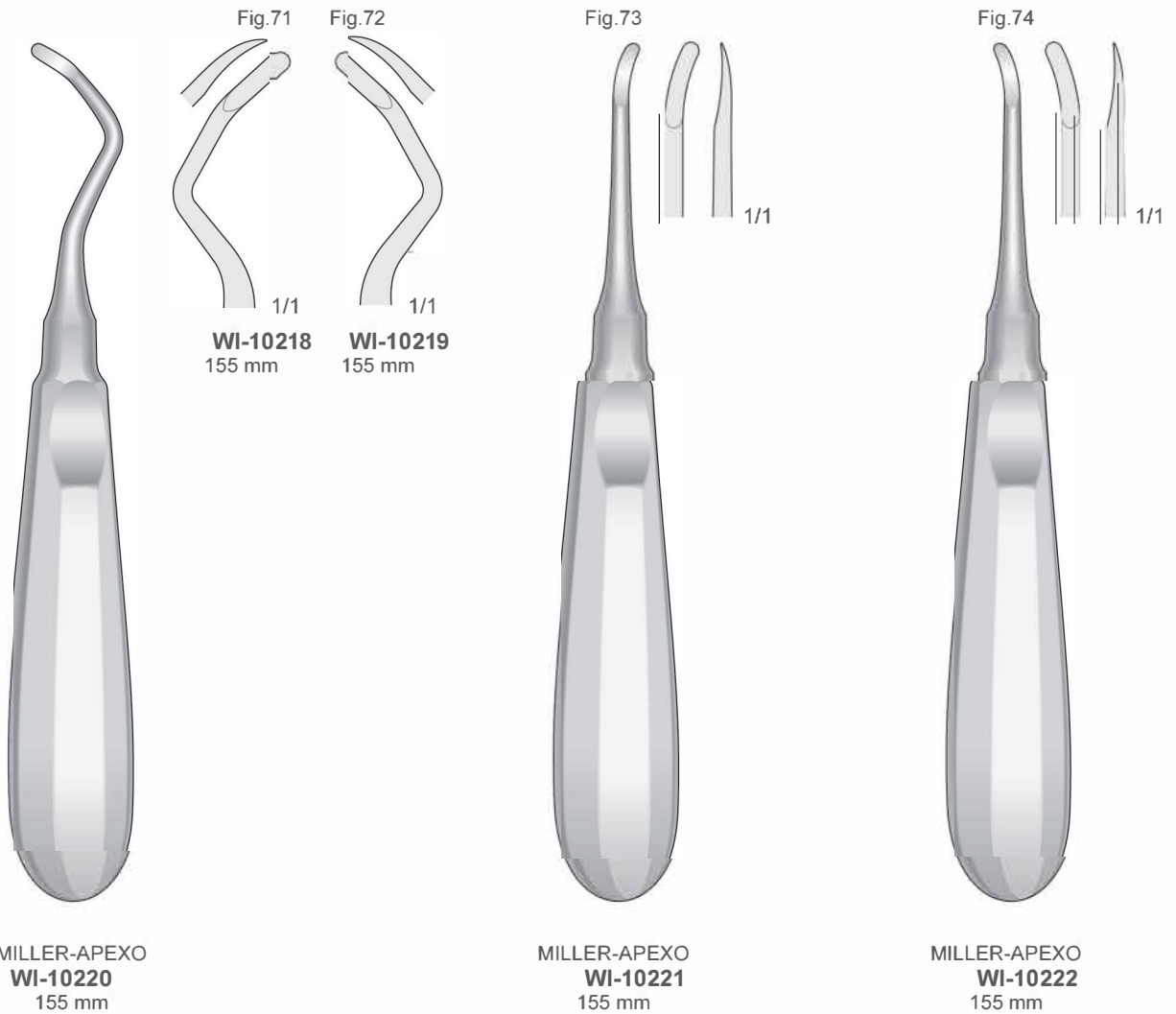



Wurzelheber
 Root Elevators
 Leve per radici
 Elevadores para raíces
 Elevateurs à racines





Wurzelheber
 Root Elevators
 Leve per radici
 Elevadores para raíces
 Elevateurs à racines

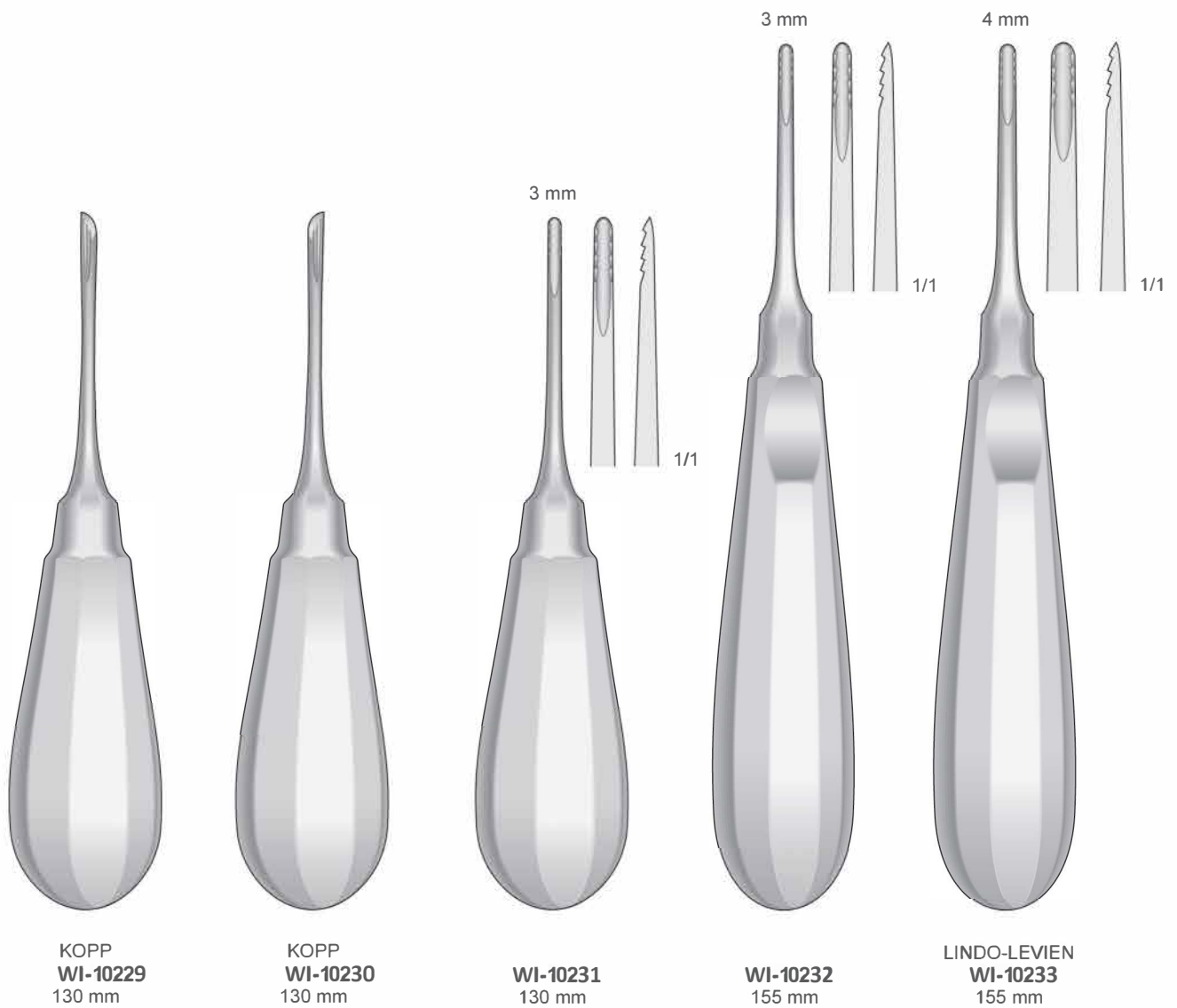



Wurzelheber
 Root Elevators
 Leve per radici
 Elevadores para raíces
 Elevateurs à racines

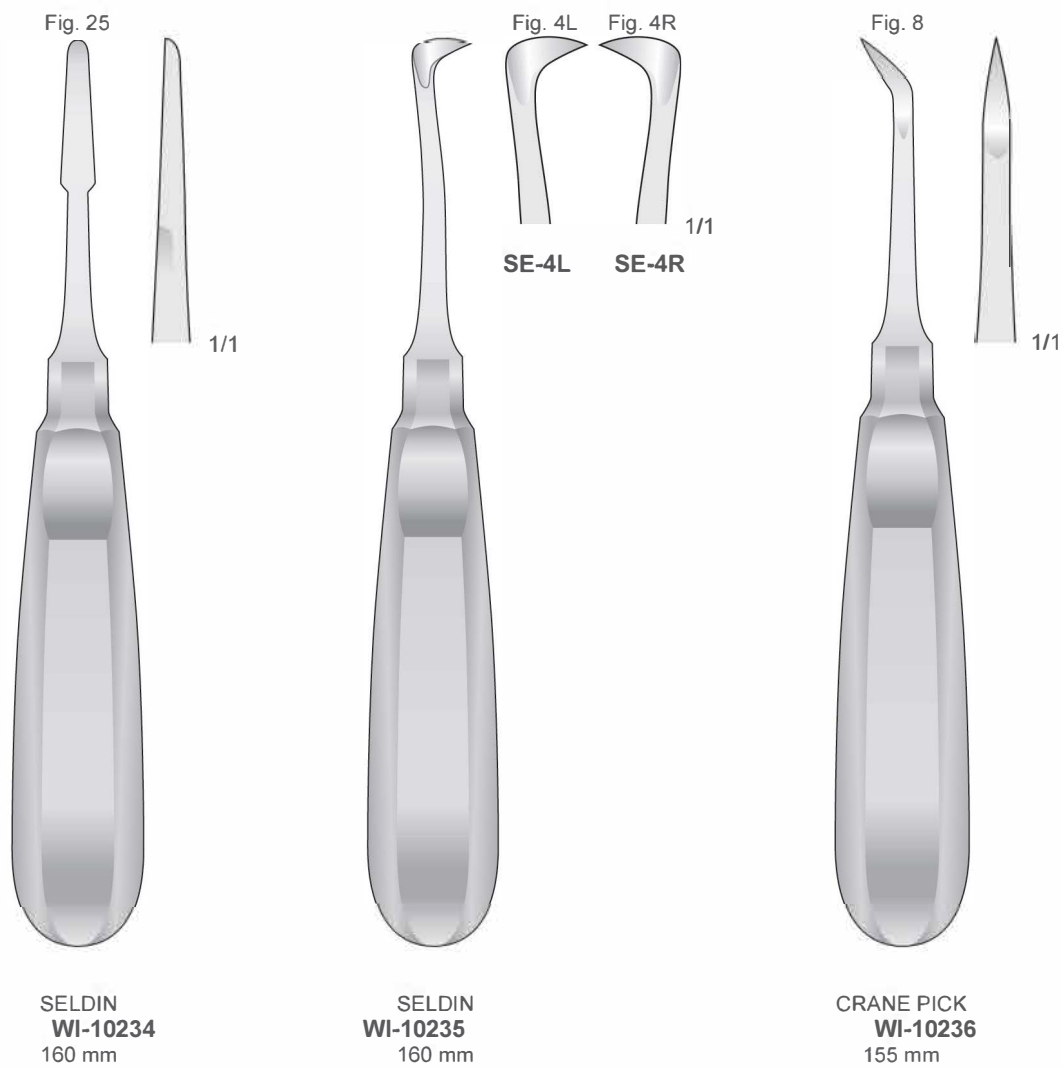



Wurzelheber
 Root Elevators
 Leve per radici
 Elevadores para raíces
 Elevateurs à racines

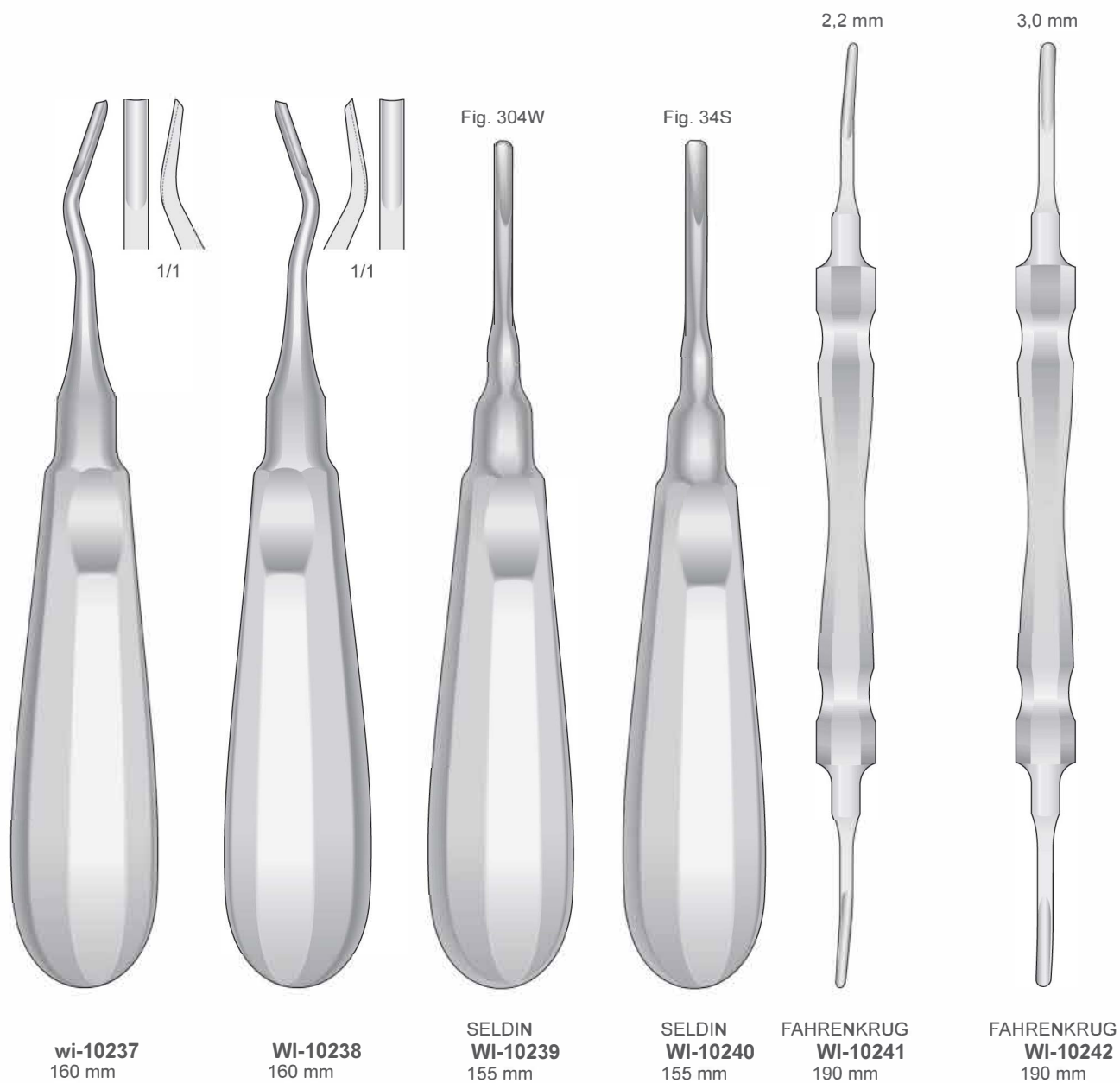



Wurzelheber
Root Elevators
Leve per radici
Elevadores para raíces
Elevateurs à racines

Fig. 6



POTT
WI-10243
160 mm

Fig. 7



POTT
WI-10244
160 mm

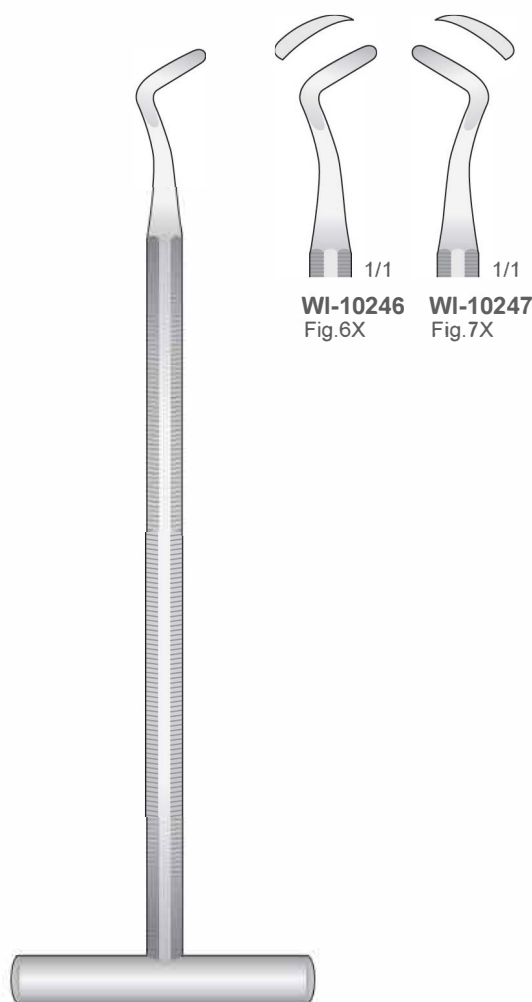



Wurzelheber
 Root Elevators
 Leve per radici
 Elevadores para raíces
 Elevateurs à racines

Syndesmotome
 Syndesmotomes
 Sindesmotomi
 Syndesmôtomos
 Syndesmotomes



BERNARD
WI-10253

Gerade
 Straight
 Diritto
 Rectas
 Droites



BERNARD
WI-10248
 150 mm

Links
 Left
 Sinistra
 A la izquierda
 À gauche



BERNARD
WI-10249
 140 mm

Rechts
 Right
 Destro
 A la derecha
 À droite



BERNARD
WI-10250
 140 mm

Bajonett - Bayonet
 Baionetta - Bayoneta
 Baionette

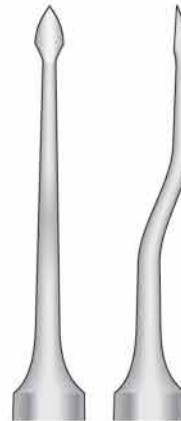

BERNARD
WI-10251
 150 mm

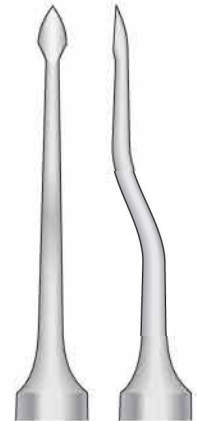

BERNARD
WI-10252
 150 mm



Wurzelheber
Root Elevators
Leve per radici
Elevadores para raíces
Elevateurs à racines

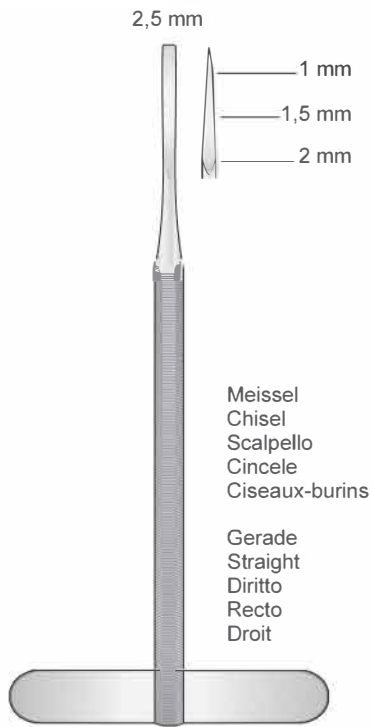

WI-10254
130 mm

Meissel
Chisel
Scalpello
Cincele
Ciseaux-burins

Gerade
Straight
Diritto
Recto
Droit

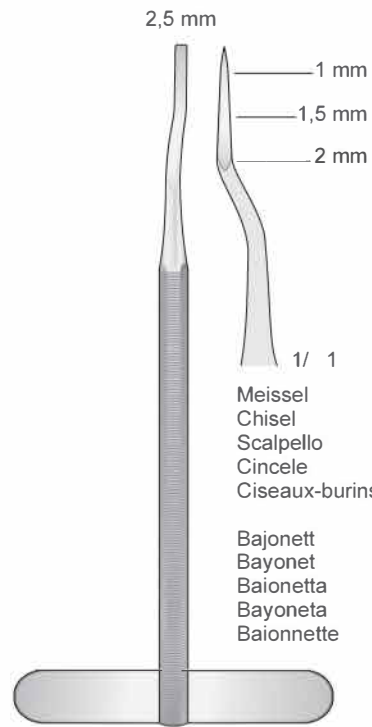

WI-10255
130 mm

Meissel
Chisel
Scalpello
Cincele
Ciseaux-burins

Bajonett
Bayonet
Baionetta
Bayoneta
Baionnette

Syndesmotome
Syndesmotomes
Sindesmotomo
Syndesmòtomos
Syndesmotomes



WI-10256
158 mm

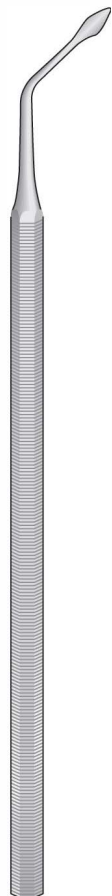

WI-10257
152 mm

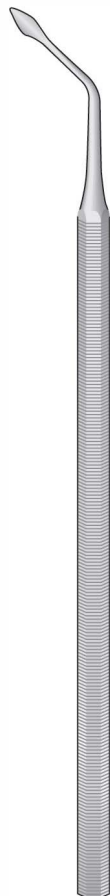

WI-10258
152 mm

Raspatorien
Raspatories
Scollaperiosteo
Legras
Rugines



WI-10259
150 mm

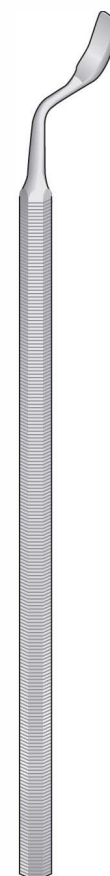

WI-10260
150 mm

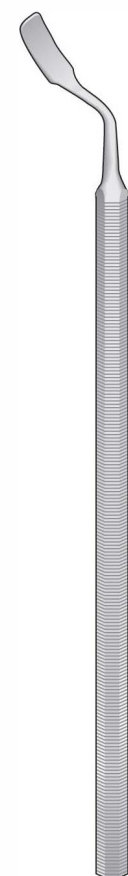

WI-10261
150 mm



Wurzelheber
Root Elevators
Leve per radici
Elevadores para rafces
Elevateurs a racines

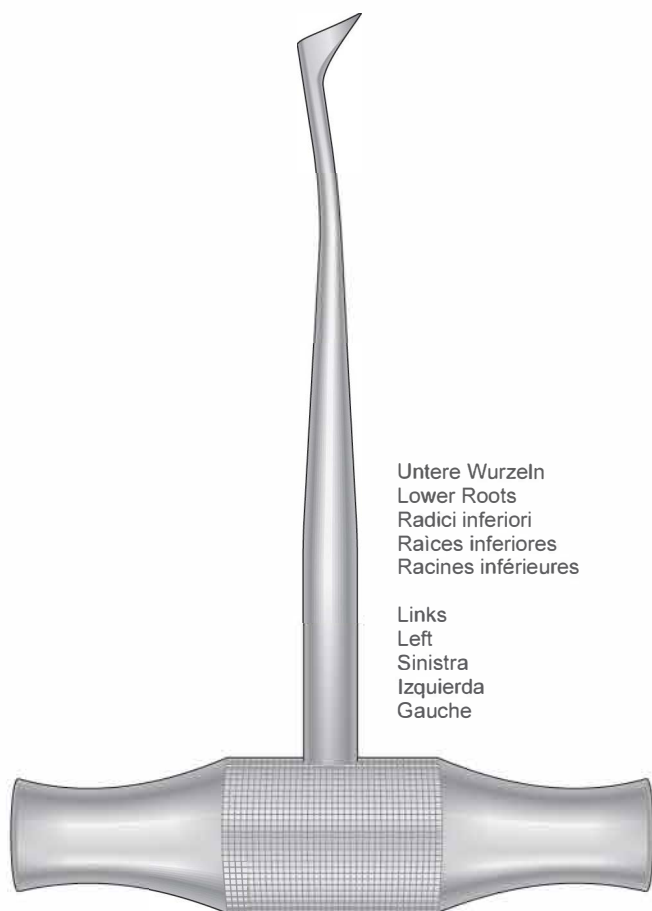

Untere Wurzeln
Lower Roots
Radici inferiori
Raices inferiores
Racines inférieures

Links
Left
Sinistra
Izquierda
Gauche

WINTER
WI-10262
Fig.1



Untere Wurzeln
Lower Roots
Radici inferiori
Raices inferiores
Racines inférieures

Rechts
Right
Destra
Derecha
Droites

WINTER
WI-10263
Fig.2



Wurzelheber
Root Elevators
Leve per radici
Elevadores para raíces
Elevateurs à racines

Fig. 1L



WINTER
WI-10264
120 mm

Fig. 1R



WINTER
wi-10265
120 mm

Fig. 14L



WINTER
WI-10266
125 mm

Fig. 14R



WINTER
WI-10267
125 mm



Wurzelheber
 Root Elevators
 Leve per radici
 Elevadores para raíces
 Elevateurs à racines

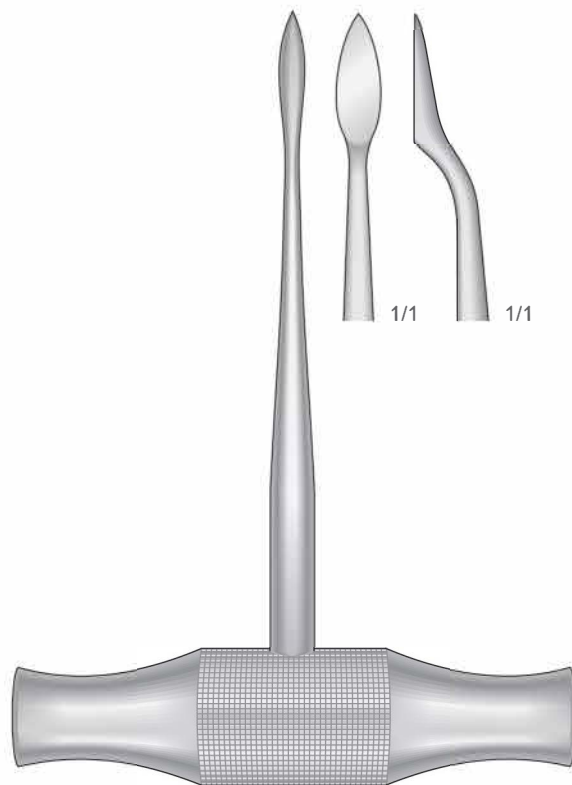

LECLUSE
WI-10268
 130 mm

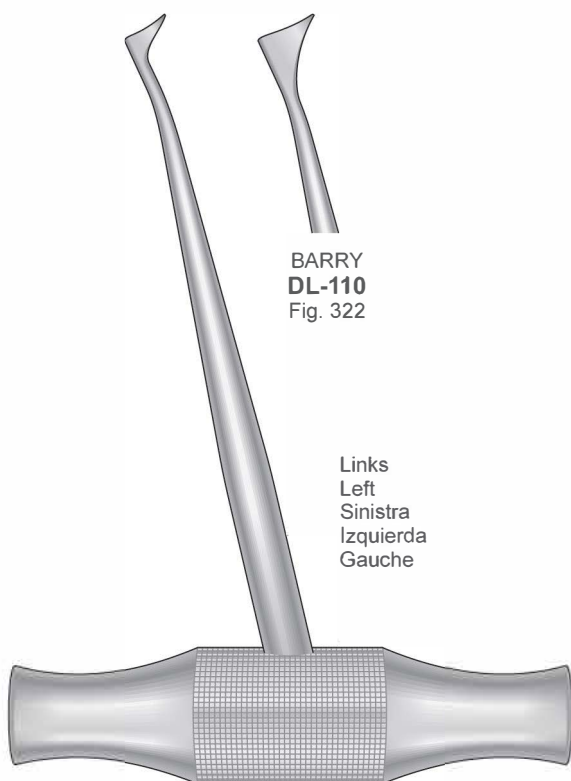

BARRY
WI-10269
 Fig. 320 115 mm

Links
 Left
 Sinistra
 Izquierda
 Gauche

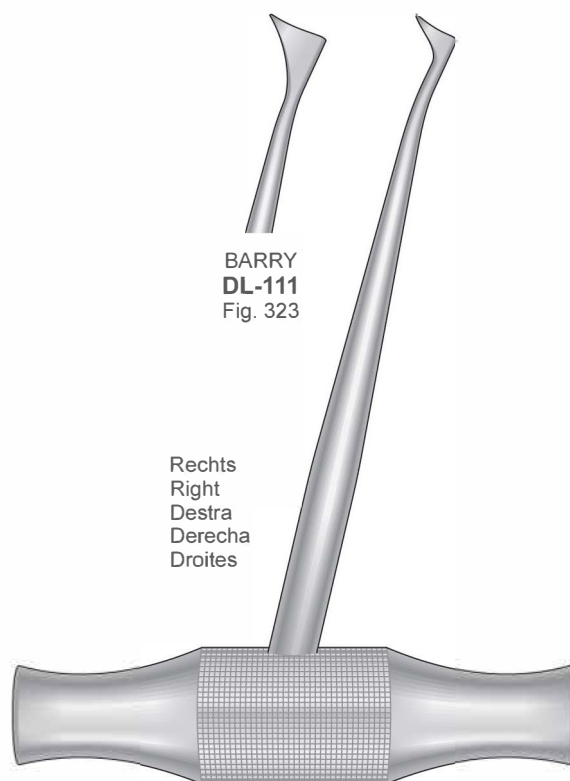

BARRY
WI-10270
 Fig. 321 115 mm

Rechts
 Right
 Destra
 Derecha
 Droites



Wurzelheber
Root Elevators
Leve per radici
Elevadores para raíces
Elevateurs à racines

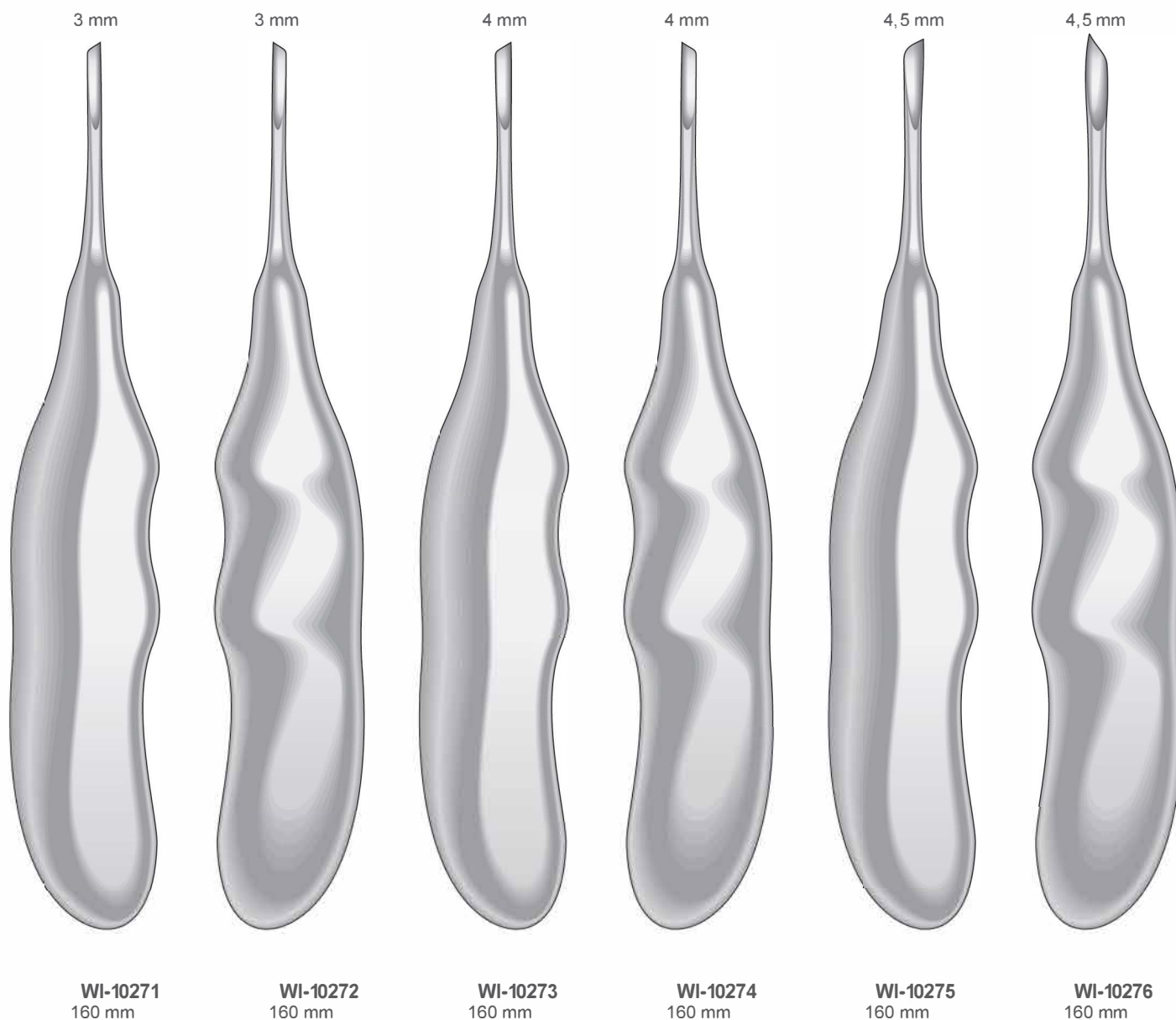



Wurzelheber
Root Elevators
Leve per radici
Elevadores para raíces
Elevateurs à racines

2 mm



WI-10277
155 mm

3 mm



WI-10278
155 mm

4 mm



WI-10279
155 mm



WI-10280
160 mm



WI-10281
160 mm



Wurzelheber
Root Elevators
Leve per radici
Elevadores para raíces
Elevateurs à racines

3 mm



WI-10282
160 mm

3 mm



WI-10283
160 mm

4 mm



WI-10284
160 mm

4 mm



WI-10285
160 mm



Skalpellgriffe - Mikro Skalpellklingen
 Scalpel Handles - Micro Scalpel Blades
 Manici per bisturi - Micro lame per bisturi
 Mangos de bisturí - Micro hojas de bisturí
 Manches pour bistouris - Micro lames de bistouri



WI-10286
 Packung 10 Klingen
 Package 10 blades
 Scatola da 10 lame
 Cajita de 10 hojas
 Boite de 10 lames

Skalpellgriffe für Mikro-Klingen
 Scalpel handles for Micro blades
 Manici per micro lame
 Mangos de bisturí para micro hojas
 Manches de bistouris pour micro lames

Micro-Klingen
 Micro blades
 Micro lame
 Micro hojas
 Micro lames

Rasierklingen-Brecker und halter
 Razor blade breaker and holder
 Manico porta lame
 Mango para Hojas de afeitador
 Porte lames à rasoir

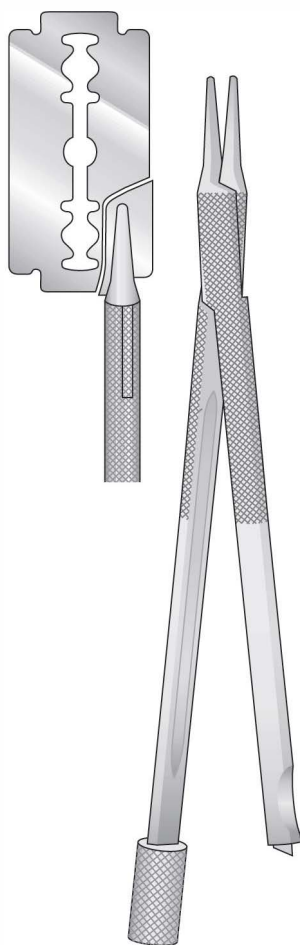

WI-10296
 120 mm



wi-10297
 135 mm



WI-10298
 155 mm



WI-10287
 Conf. 10 pz.



WI-10288/8
 Conf. 10 pz.



WI-10289
 Conf. 1 pz.



WI-10290
 Conf. 10 pz.



WI-10291
 Conf. 10 pz.



WI-10292
 Conf. 1 pz.



WI-10293
 Conf. 10 pz.



WI-10294
 Conf. 10 pz.



WI-10295
 Conf. 1 pz.



Skalpelligriffe
Scalpel Handles
Manici porta lame
Mangos de bisturí
Manches de bistouri

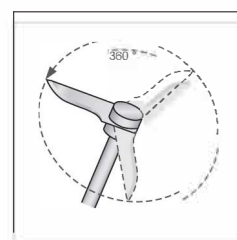

Für Mikro-Klingen
For Micro Blades
Per micro lame
Para micro Hojas
Pour Micro-Lame de bistouris



WI-10299
100 mm



WI-10300
130 mm



wi-10301
150 mm

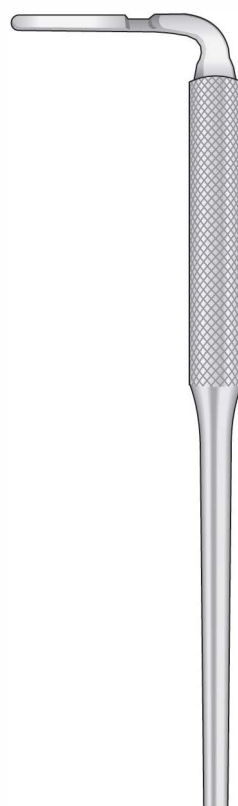

WI-10302
120 mm

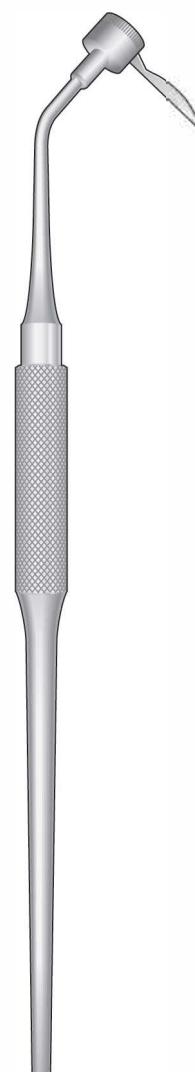

WI-10303
165 mm



Skalpelle und Skalpellgriffe
 Scalpel Blades and Handle
 Lame e manici per bisturi
 Hojas y mangos de bisturí
 Lames et manches de bistouri

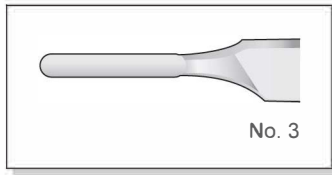

Packungen à 100
 Packages of 100 ea
 Scatole da 100 pezzi
 Cajas de 100 c/u
 Boîtes de 100 pièces



WI-10304
Fig. 10



WI-10305
Fig. 11

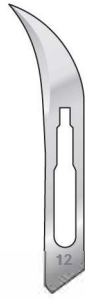

WI-10306
Fig. 12



WI-10307
Fig. 12D



WI-10308
Fig. 13

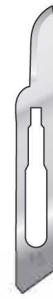

WI-10309
Fig. 15

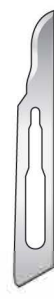

WI-10310
Fig. 15A

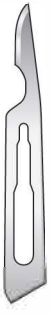

WI-10311
Fig. 15C



WI-10312



WI-10313
Fig. 3M



WI-10314



WI-10315



WI-10316
Fig. 5



wi-10317
Fig. 5A



WI-10318
155 mm

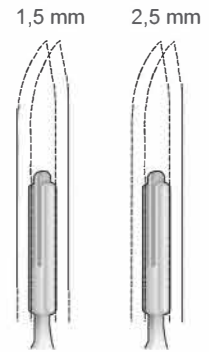

WI-10319 WI-10320

Doppelt Skalpellgriff
 Scalpel Handle double Blade
 Manico per bisturi a doppia lama
 Mango de bisturí doble hojas
 Manche pour bistouri double-lames



Skalpelle
Scalpel Blades
Lame per bisturi
Hojas de bisturí
Lames de bistouri

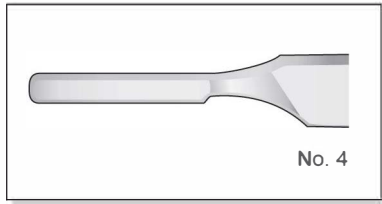

No. 4

Packungen à 100
Packages of 100 ea
Scatole da 100 pezzi
Cajas de 100 c/u
Boîtes de 100 pièces



wi-10321
Fig. 18



WI-10322
Fig. 20



WI-10323
Fig. 21



WI-10324
Fig. 23

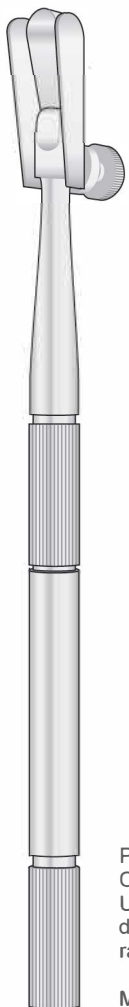

Palatal, Gingival,
Connective Tissue Grafts
Uses standard
double-edged
razor blade

Mucotomo

PAQUETTE
BLADE HOLDER
WI-10325
160 mm



WI-10326
Fig. 4

Klingenentfemer
Scalpel blade removing forceps
Pinze togliilama
Pinza para quitar hojas de bisturías
Pince pour enlever les lames de bistouris

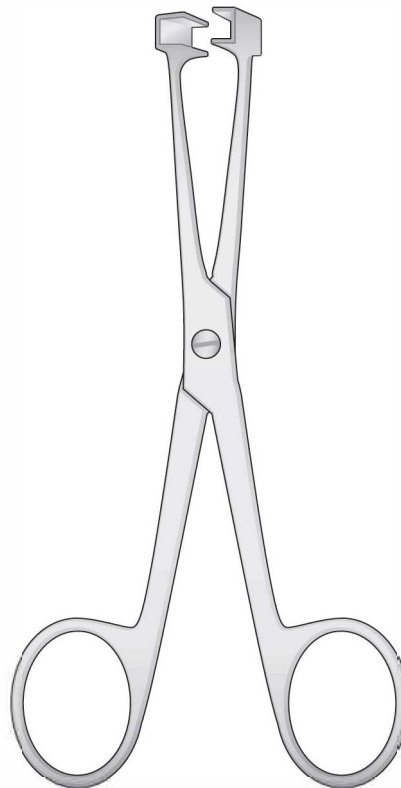

WI-10327
135 mm

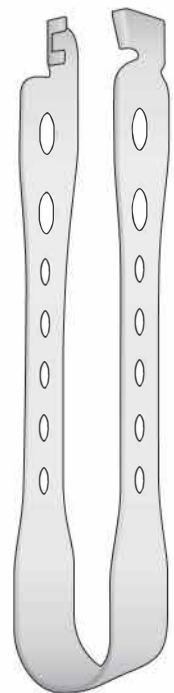

WI-10328
115 mm



Messer
Knives
Coltelli
Cuchillos
Couteaux



ZIEGLER
WI-10336
115 mm

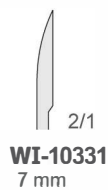

GRAEFE
WI-10337



GRAEFE
wi-103387
140 mm

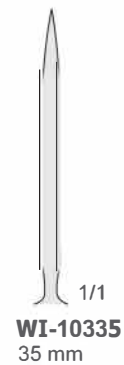
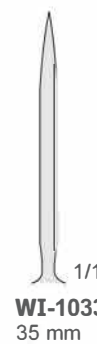

LA FORCE
WI-10338
120 mm



ELLIS
WI-10339
120 mm



WI-10340
125 mm

2 mm



WI-10341
125 mm



2 mm



WI-10342
125 mm



Messer
Knives
Coltelli
Cuchillos
Couteaux



WI-10349



WI-10343
120 mm



WI-10344
125 mm



WI-10345
130 mm



WI-10346
120 mm



WI-10347
125 mm



wi-10348
130 mm



Mikro-Scheren
Micro Scissors
Micro Forbici
Micro Tijeras
Micro Ciseaux

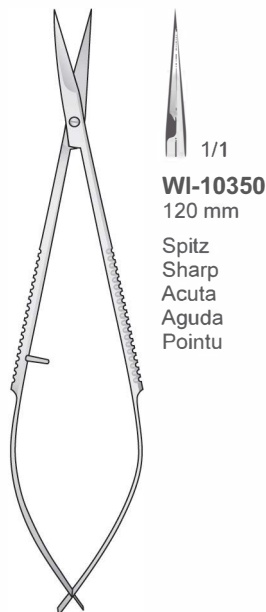

1/1
WI-10350
120 mm
Spitz
Sharp
Acuta
Aguda
Pointu

NOYES
WI-10354
120 mm



1/1
WI-10351
120 mm
Spitz
Sharp
Acuta
Aguda
Pointu

NOYES
WI-10355
120 mm

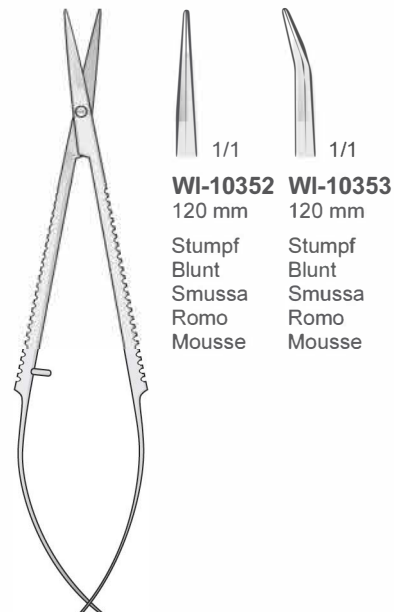

1/1 1/1
WI-10352 **WI-10353**
120 mm 120 mm
Stumpf
Blunt
Smussa
Romo
Mousse

WI-10356
120 mm

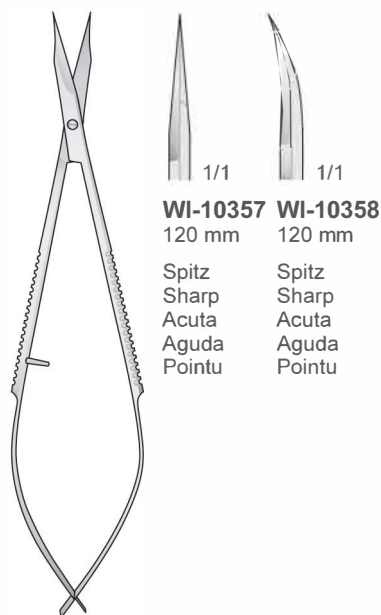

1/1 1/1
WI-10357 **WI-10358**
120 mm 120 mm
Spitz
Sharp
Acuta
Aguda
Pointu

WESTCOTT
WI-10363
120 mm



1/1 1/1
WI-10359 **WI-10360**
120 mm 120 mm
Stumpf
Blunt
Smussa
Romo
Mousse

WESTCOTT
WI-10364
120 mm

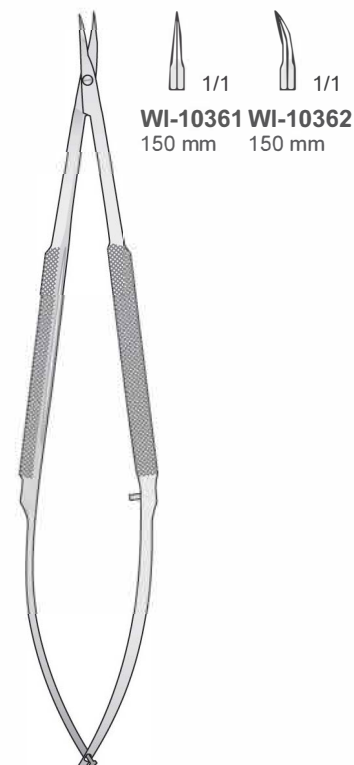

1/1 1/1
WI-10361 **WI-10362**
150 mm 150 mm

WI-10365
150 mm



Scheren
Scissors
Forbici
Tijeras
Ciseaux

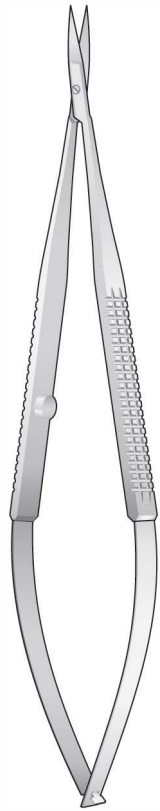

WI-10370
160 mm



WI-10366
160 mm
Spitz
Sharp
Acuta
Aguda
Pointu

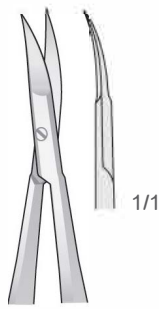

WI-10367
160 mm
Spitz
Sharp
Acuta
Aguda
Pointu

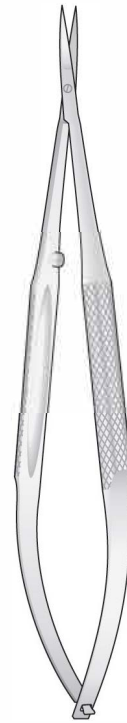

WI-10371
145 mm

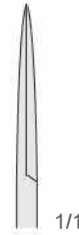

WI-10368
145 mm
Spitz
Sharp
Acuta
Aguda
Pointu



WI-10369
145 mm
Spitz
Sharp
Acuta
Aguda
Pointu

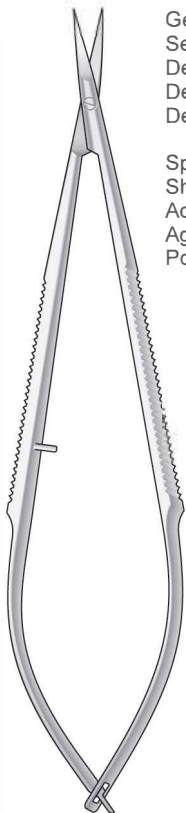

WI-10372
160 mm

Gezahnt
Serrated
Dentellata
Dentada
Dentelé

Spitz
Sharp
Acuta
Aguda
Pointu

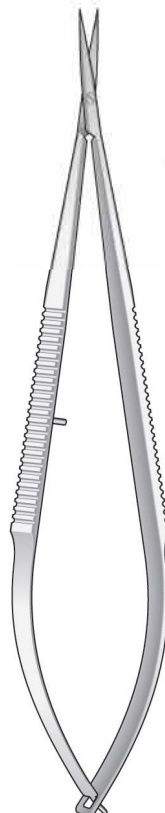

WI-10373
160 mm



WI-10373A
160 mm
Spitz
Sharp
Acuta
Aguda
Pointu



WI-10374
160 mm



WI-10374A
160 mm
Spitz
Sharp
Acuta
Aguda
Pointu



Scheren
Scissors
Forbici
Tijeras
Ciseaux

Spitz - Sharp
Acuta - Aguda
Pointu

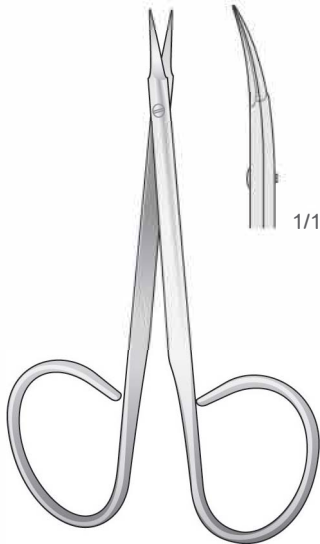

STITCH
WI-10377
115 mm

Iris Scheren - Iris scissors
Forbici Iris - Tijeras Iris
Ciseaux Iris

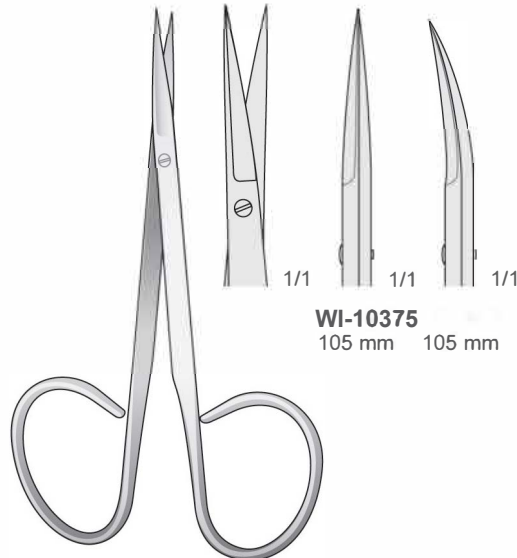

WI-10378
105 mm

WI-10375
105 mm 105 mm

Stumpf - Blunt
Smussa - Romas
Mousse

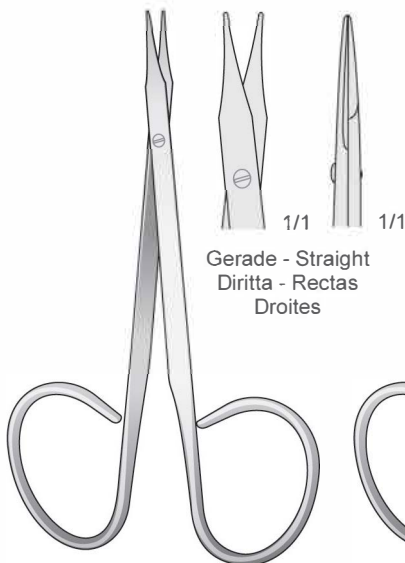

STEVENS
WI-10379
100 mm

Stumpf - Blunt
Smussa - Romas
Mousse

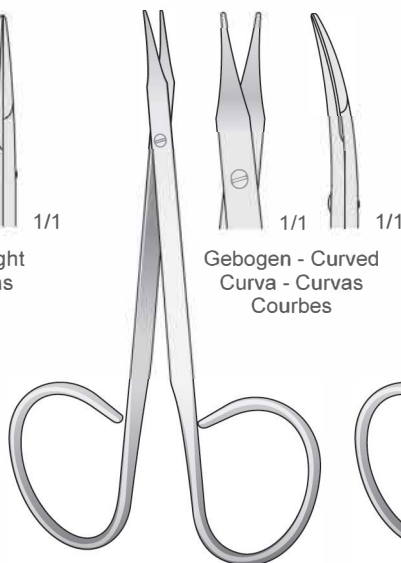

STEVENS
WI-10380
100 mm

Spitz - Sharp
Acuta - Aguda
Pointu

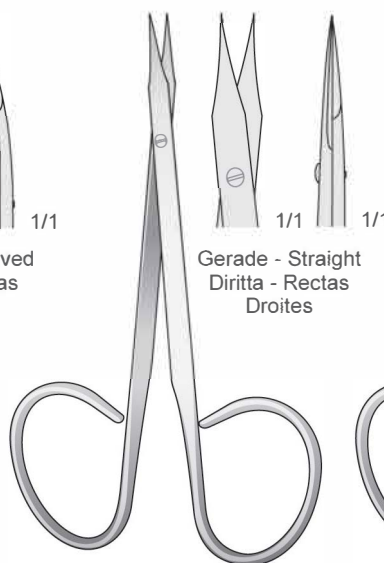

WALTON
WI-10381
100 mm

Spitz - Sharp
Acuta - Aguda
Pointu

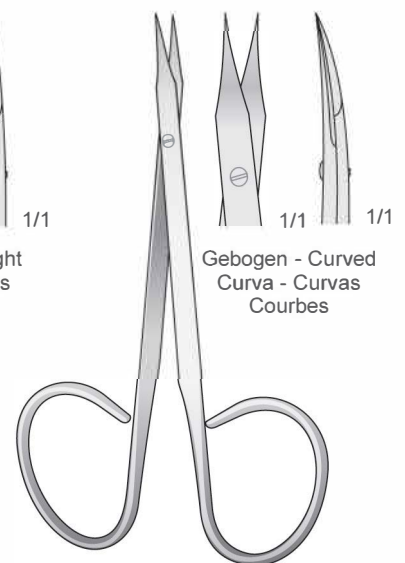

WALTON
WI-10382
100 mm

Gerade - Straight
Diritta - Rectas
Droites

Gebogen - Curved
Curva - Curvas
Courbes

Gerade - Straight
Diritta - Rectas
Droites

Gebogen - Curved
Curva - Curvas
Courbes



Scheren
Scissors
Forbici
Tijeras
Ciseaux

L = links
left
mancini
izquierdo
gauche

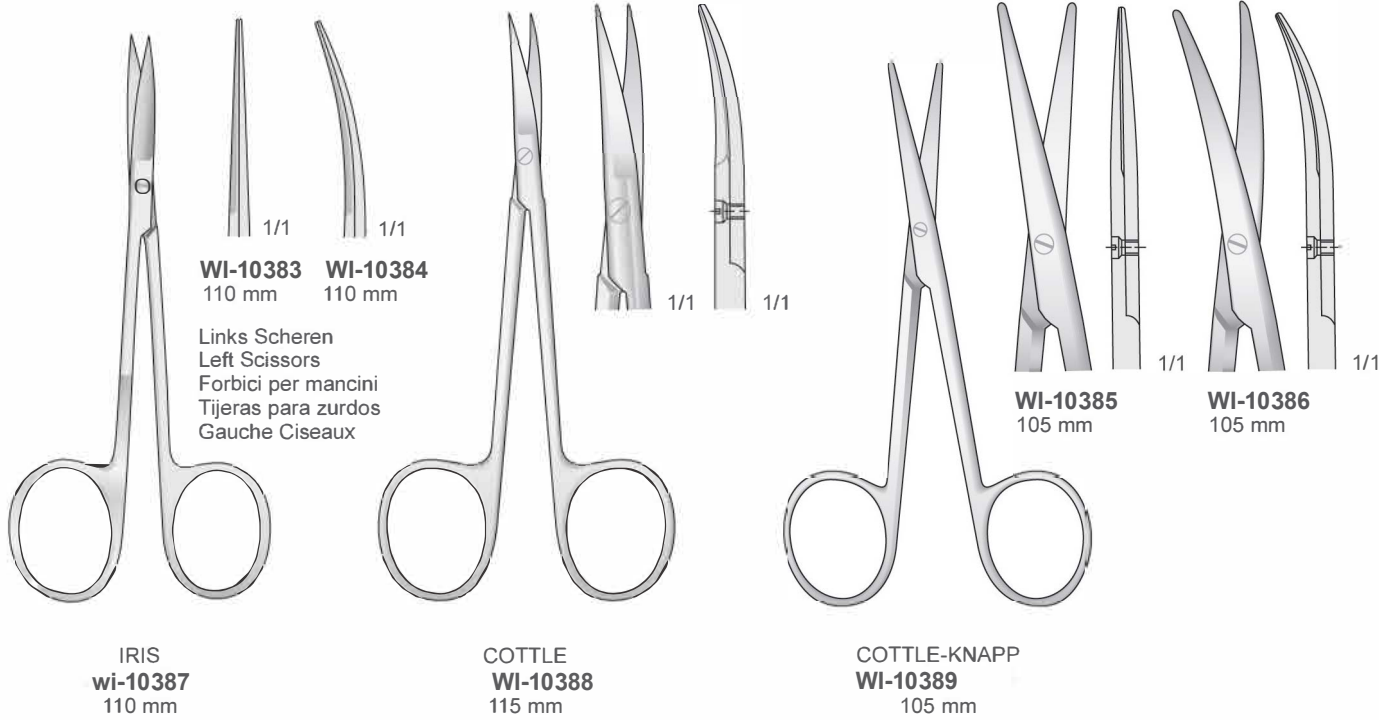

IRIS
wi-10387
110 mm

COTTLE
wi-10388
115 mm

COTTLE-KNAPP
wi-10389
105 mm

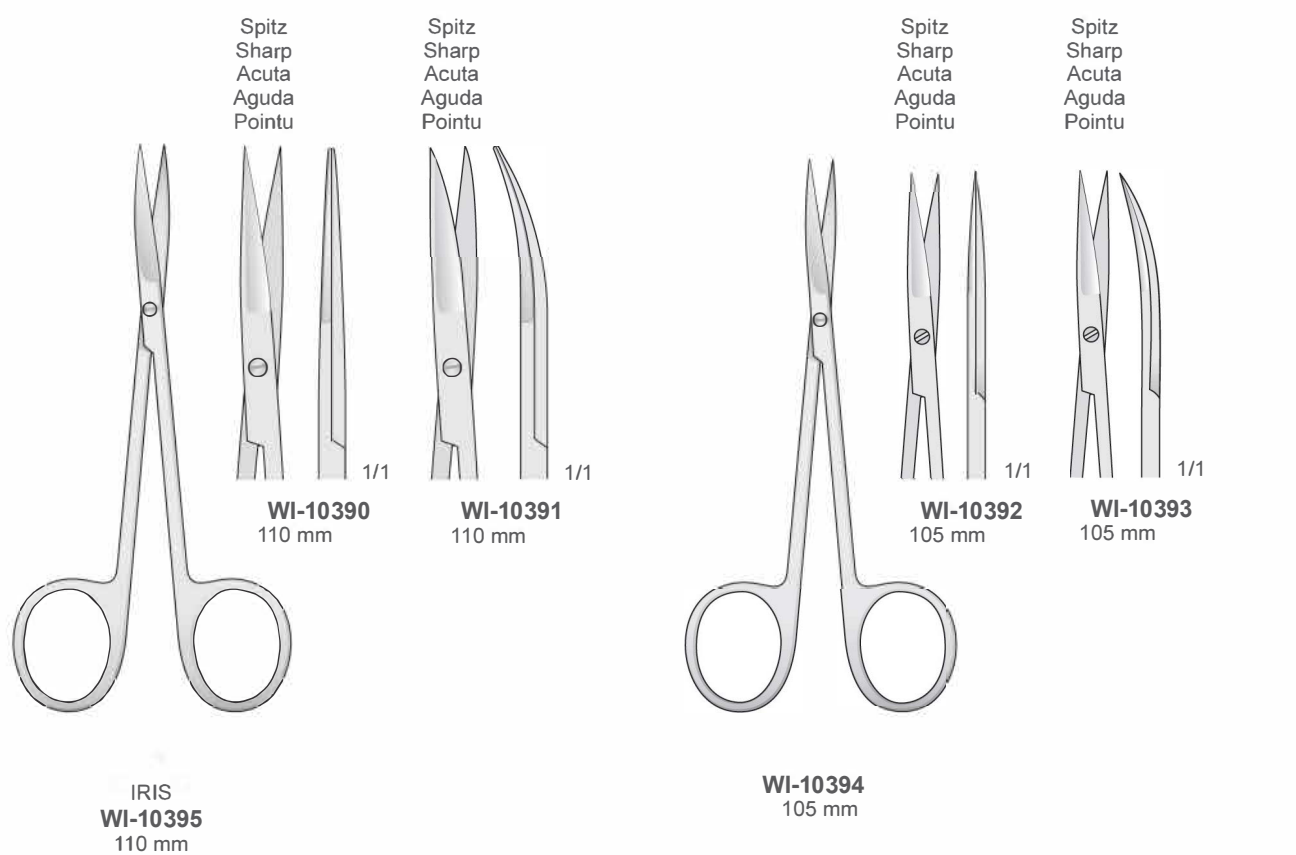

IRIS
wi-10395
110 mm

wi-10394
105 mm



Scheren
Scissors
Forbici
Tijeras
Ciseaux

Gezahnt - Serrated
Dentellata - Dentelé - Dentadas



WI-10400
110 mm

Gezahnt - Serrated
Dentellata - Dentelé - Dentadas

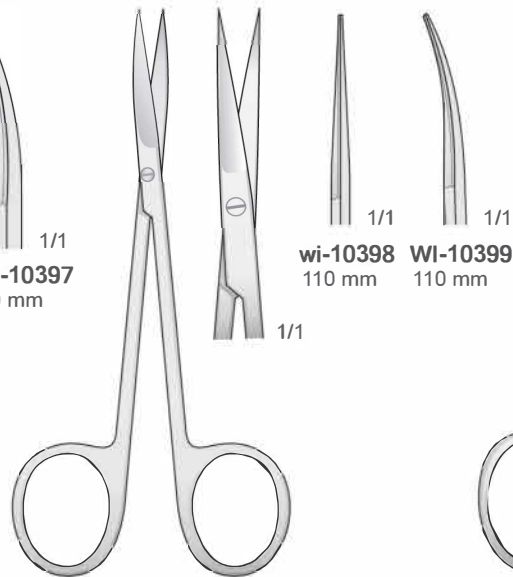

WI-10401
110 mm



KILNER
WI-10402
115 mm

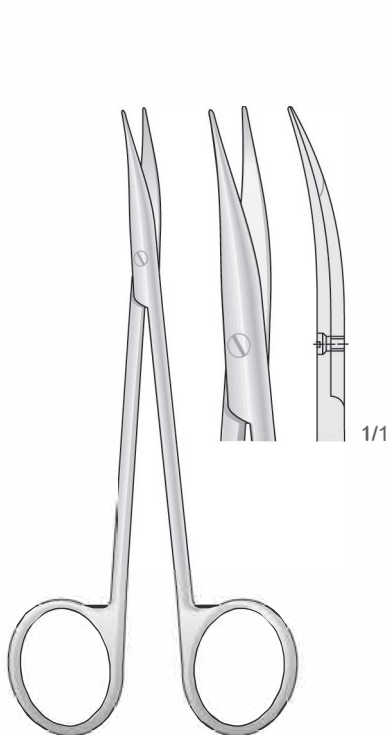

JAMESON-WERBER
wi-10404

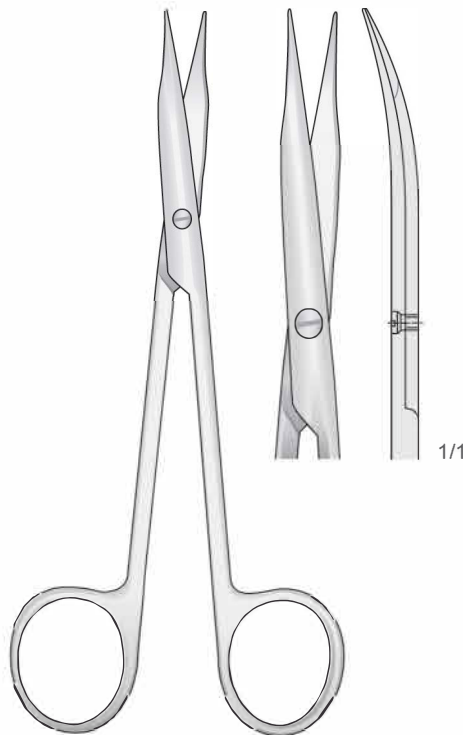

45 mm
JAMESON
WI-10405

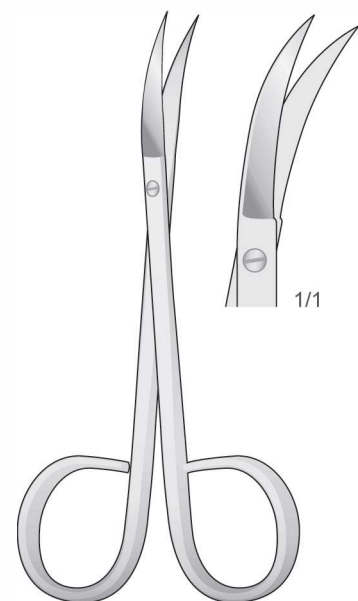

WI-10403
115 mm



Scheren
Scissors
Forbici
Tijeras
Ciseaux

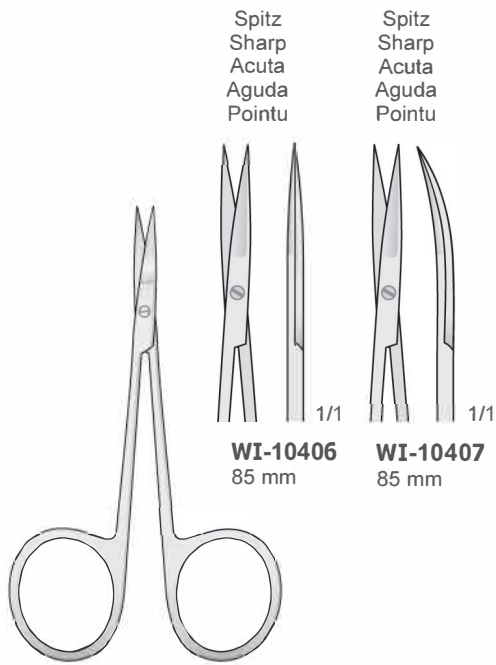

MICO-IRIS
WI-10410
85 mm

WI-10411
110mm

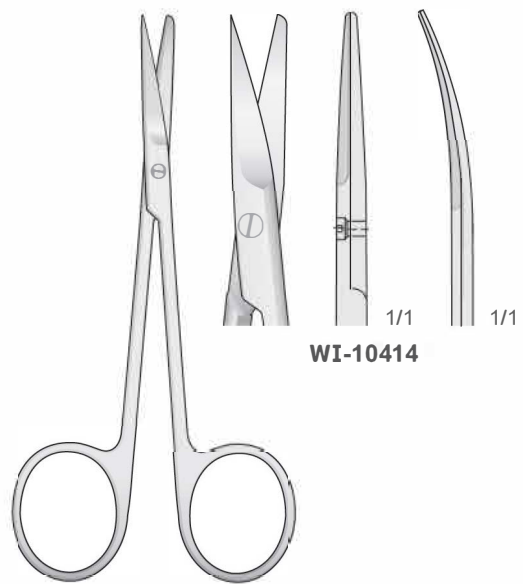
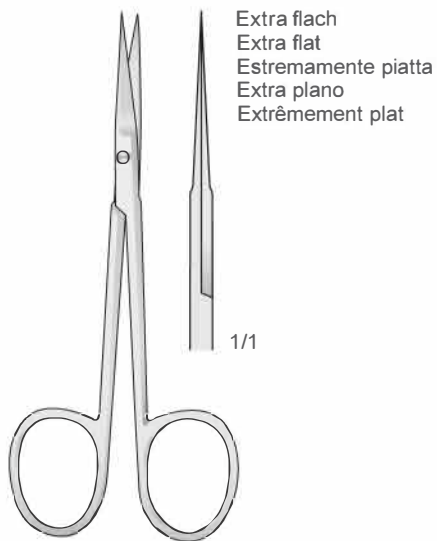



Scheren
Scissors
Forbici
Tijeras
Ciseaux

Spitz - Sharp
Acuta - Agudo
Aigu

Spitz - Sharp
Acuta - Agudo
Aigu



WI-10415

WI-10416

**METZENBUM
WI-10418**
145 mm

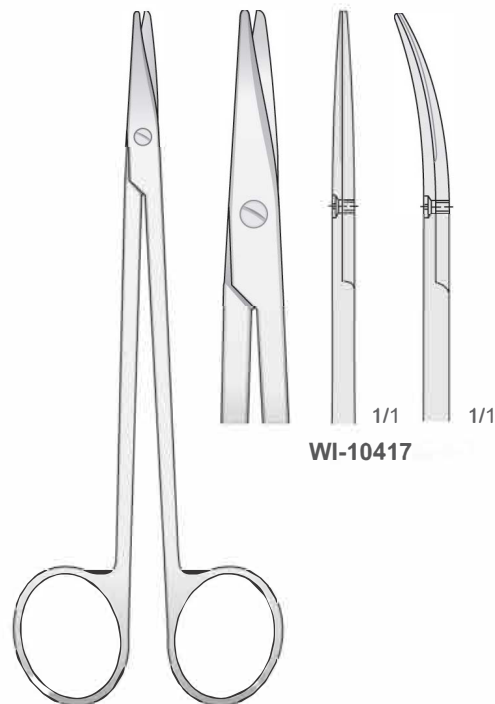

WI-10417

**METZENBAUM
WI-10419**
150 mm

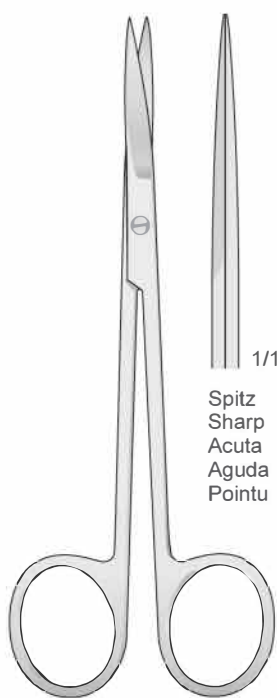

1/1
Spitz
Sharp
Acuta
Aguda
Pointu

**METZENBAUM
WI-10420**
145 mm

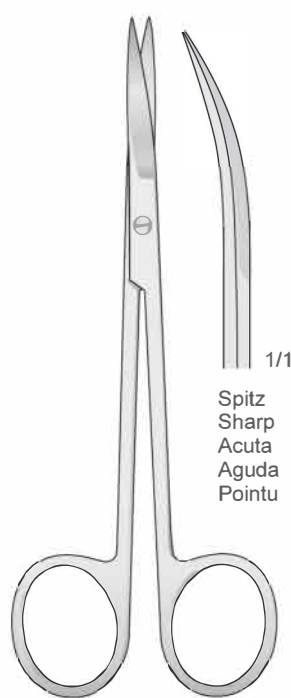

1/1
Spitz
Sharp
Acuta
Aguda
Pointu

**METZENBAUM
WI-10421**
145 mm



WI-10422
150 mm

WI-10423
150 mm

**JOEPH
WI-10424**
150 mm



Scheren
Scissors
Forbici
Tijeras
Ciseaux

Stumpf
Blunt
Smussa
Romas
Mousse

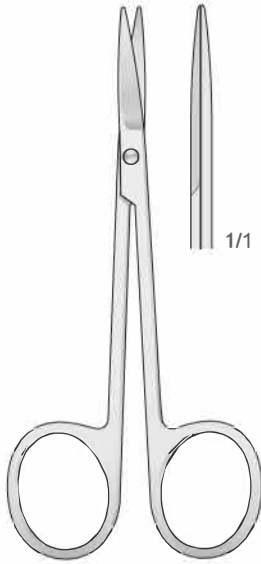

WI-10425
110 mm

Stumpf
Blunt
Smussa
Romas
Mousse

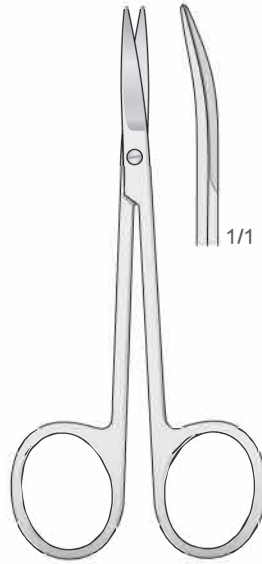

WI-10426
110 mm

Stumpf
Blunt
Smussa
Romas
Mousse

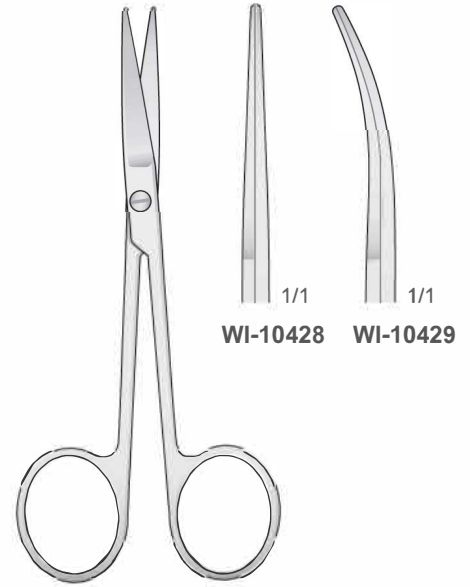

WI-10427
115 mm

Spitz
Sharp
Acute
Agudas
Pointu

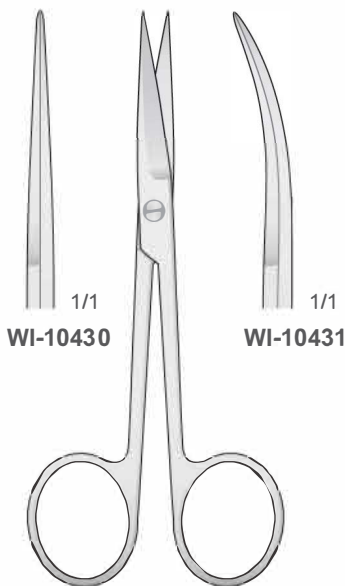

WI-10430

WI-10432
115 mm



WI-10431

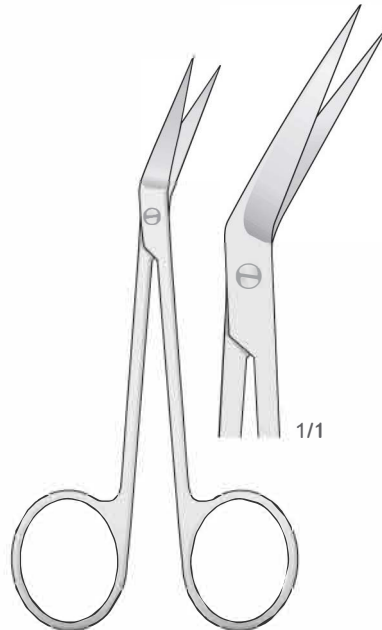

LOCKLIN
WI-10433
115 mm

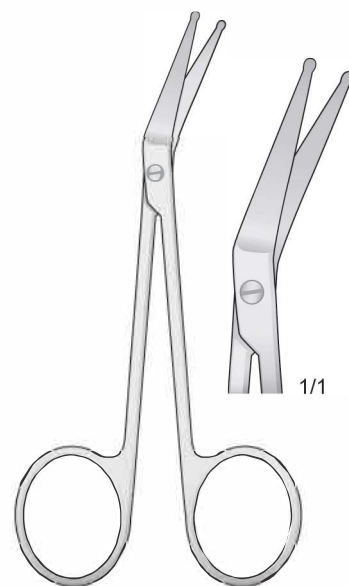

LOCKLIN MOD.
WI-10434
110 mm



Scheren
Scissors
Forbici
Tijeras
Ciseaux



KILNER
WI-10435
130 mm

Mit einer Schneide gezahnt
With one blade serrated
Con una lama zigrinata
Con una hoja dentada
Avec lame dentelé

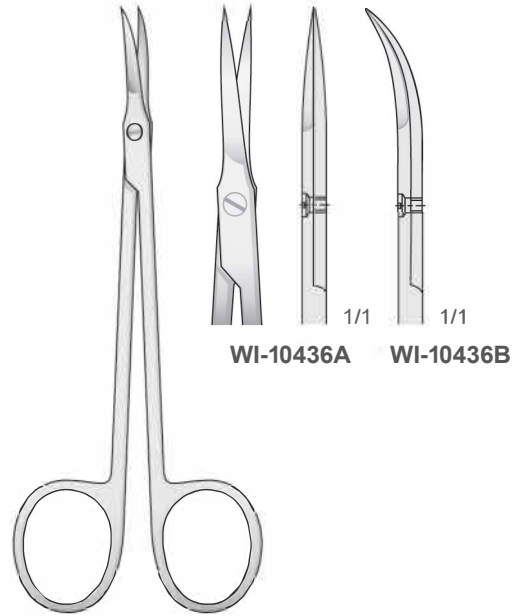

WI-10436
120 mm

Gezahnt - Serrated
Dentellata - Dentadas
Dentelé

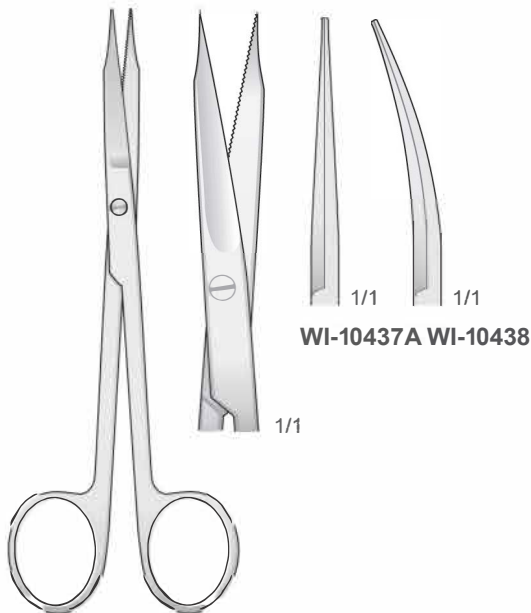

GOLDMAN-FOX
WI-10437

Gezahnt - Serrated
Dentellata - Dentadas
Dentelé

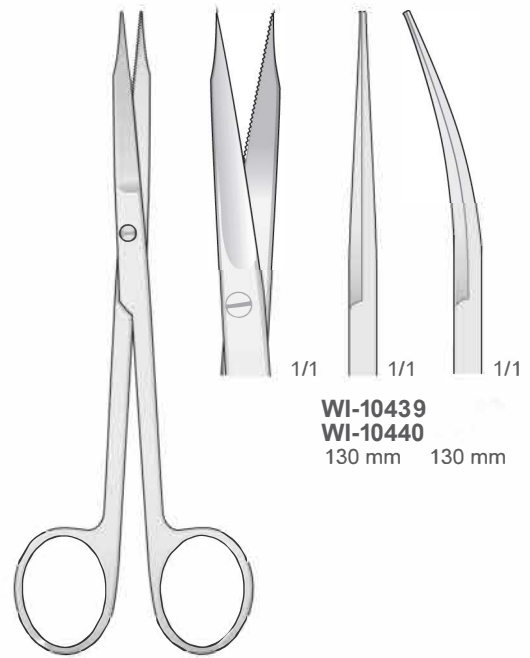

GOLDMAN-FOX
WI-10441
130 mm



Scheren
Scissors
Forbici
Tijeras
Ciseaux

Gezahnt - Serrated
Dentellata - Dentadas
Dentelé



LOCKLIN
WI-10442
160 mm

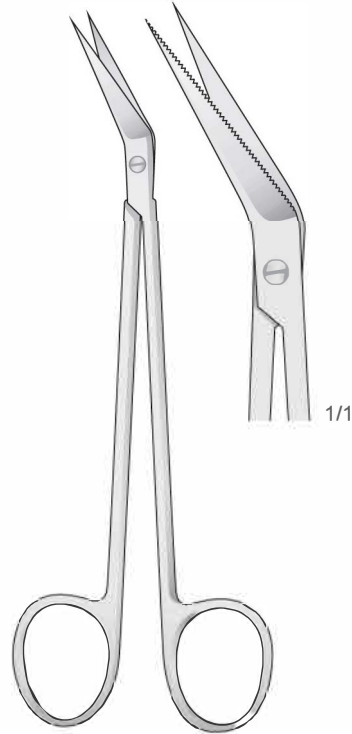

LOCKLIN
WI-10443
160 mm

Gezahnt - Serrated
Dentellata - Dentadas
Dentelé

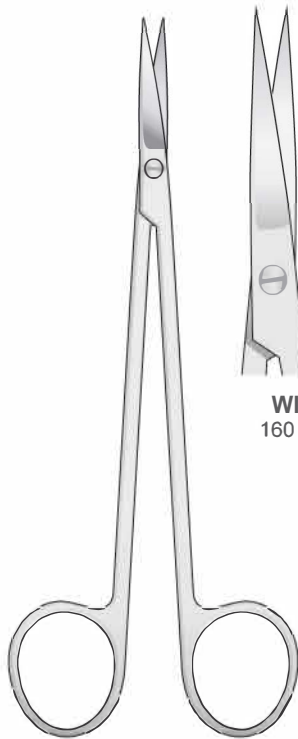

KELLY
WI-10448
160 mm

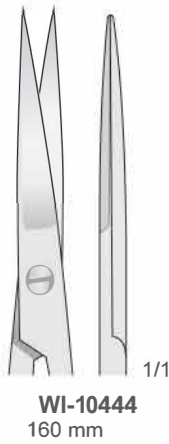

WI-10444
160 mm



WI-10445
160 mm

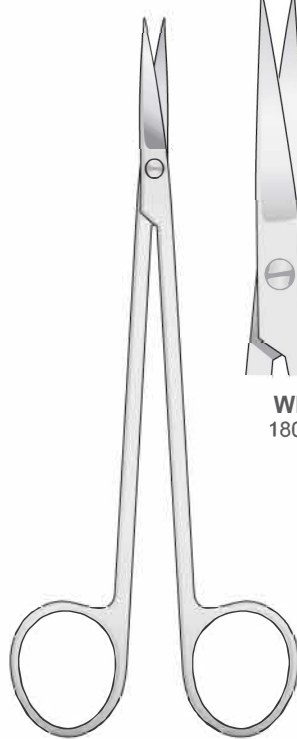

KELLY
WI-10449
180 mm

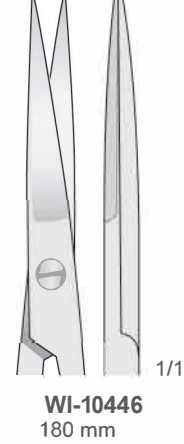

WI-10446
180 mm

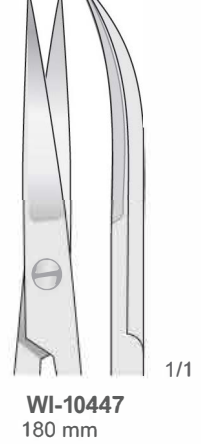

WI-10447
180 mm



Scheren
Scissors
Forbici
Tijeras
Ciseaux

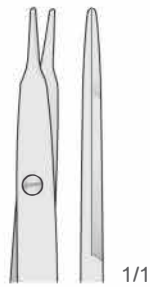
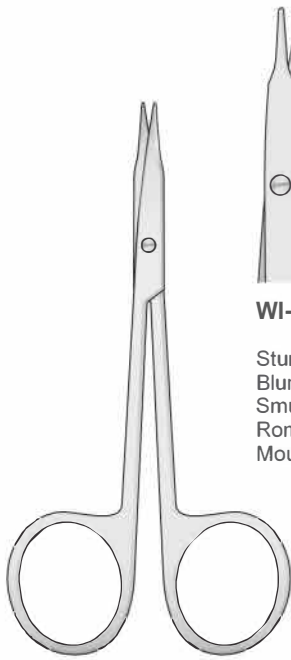

WI-10450

Stumpf Gerade
Blunt Straight
Smussa Diritta
Romas Rectas
Mousse Droites

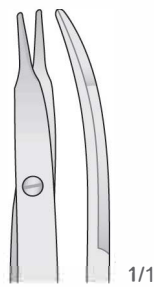

WI-10451

Stumpf Gebogen
Blunt Curved
Smussa Curva
Romas Curvas
Mousse Courbes

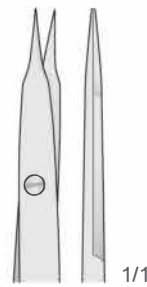

WI-10452

Spitz Gerade
Sharp Straight
Acuta Diritta
Agudas Rectas
Pointu Droites

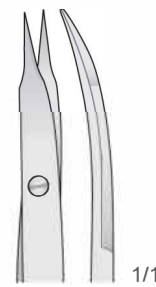

WI-10453

Spitz Gebogen
Sharp Curved
Acuta Curva
Agudas Curvas
Pointu Courbes

STEVENS
WI-10454
110 mm

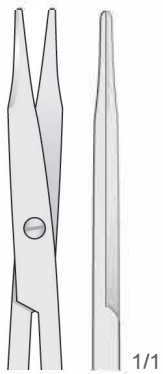
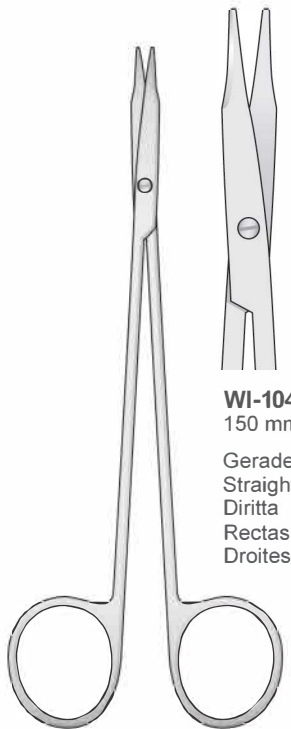

WI-10455
150 mm

Gerade
Straight
Diritta
Rectas
Droites

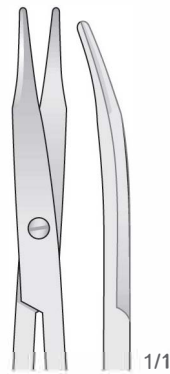

wi-10456
150 mm

Gebogen
Curved
Curva
Curvas
Courbes

Stumpf
Blunt
Smussa
Romas
Mousse

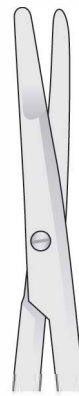

WI-10457 WI-10457 A
120 mm 120 mm

Gerade Gebogen
Straight Curved
Diritta Curva
Rectas Curvas
Droites Courbes

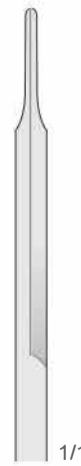

WI-10458
WI-10459
135 mm 135 mm

Gerade Gebogen
Straight Curved
Diritta Curva
Rectas Curvas
Droites Courbes



KILNER
WI-10461

Stumpf
Blunt
Smussa
Romas
Mousse

REYNOLDS
WI-10460



Gezahnt - Serrated
Dentellata - Dentadas
Dentelé

Scheren
Scissors
Forbici
Tijeras
Ciseaux

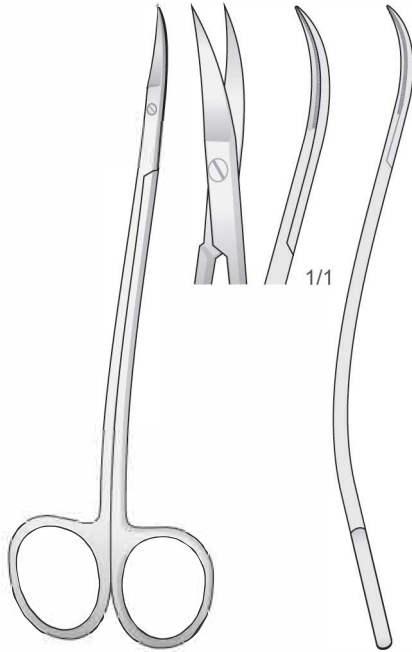

LA GRANGE
WI-10462
115 mm

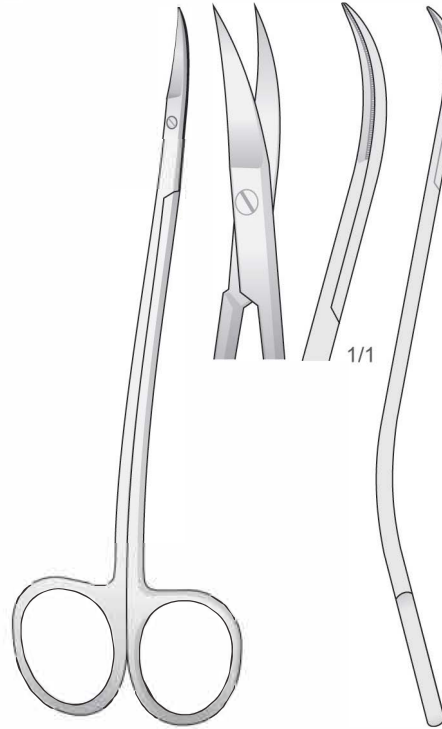

LA GANGE
WI-10463
Gezahnt - Serrate
Dentellata - Dentada
55 mm

Dentée

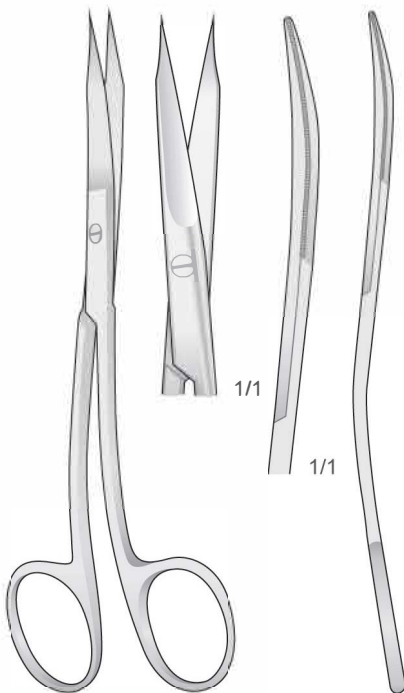

GOLDMAN-FOX S
FORM WI-10464
130 mm

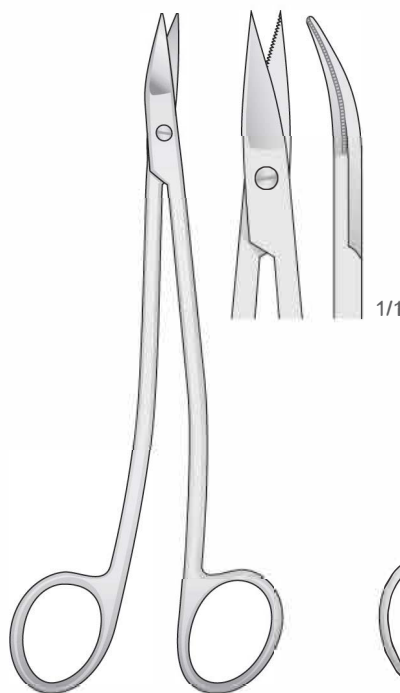

NEUMANN
WI-10465
130 mm

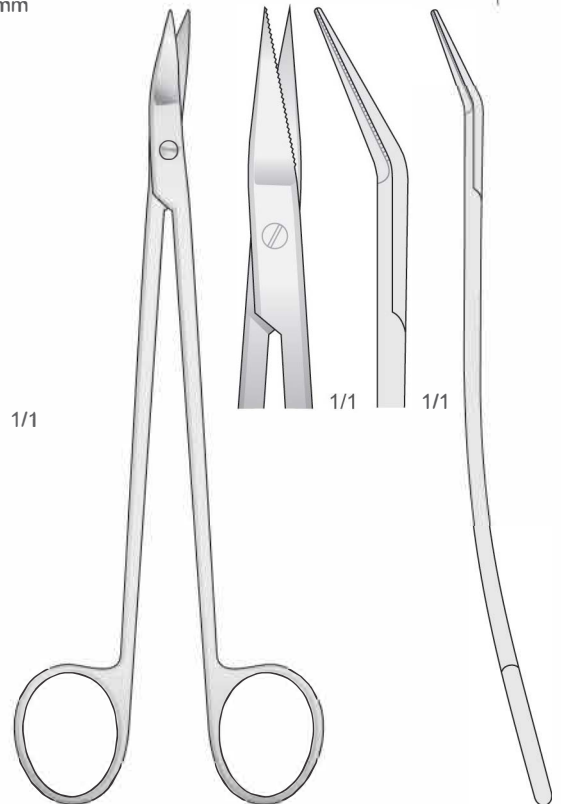

DEAN
WI-10466
DEAN
180 mm



Scheren
Scissors
Forbici
Tijeras
Ciseaux

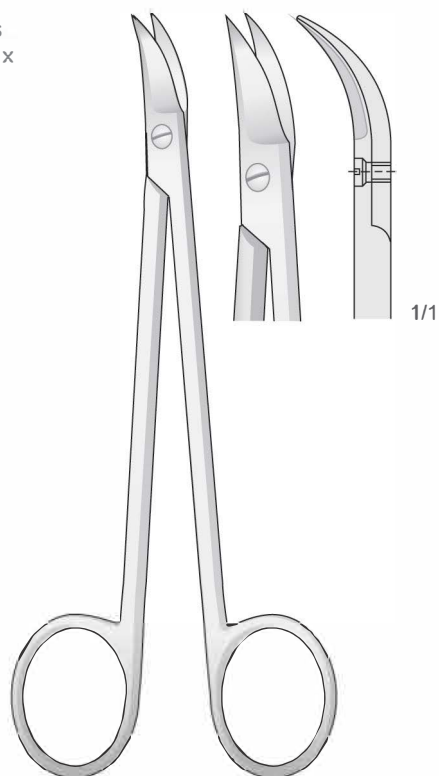

QUINBY
WI-10467
130 mm

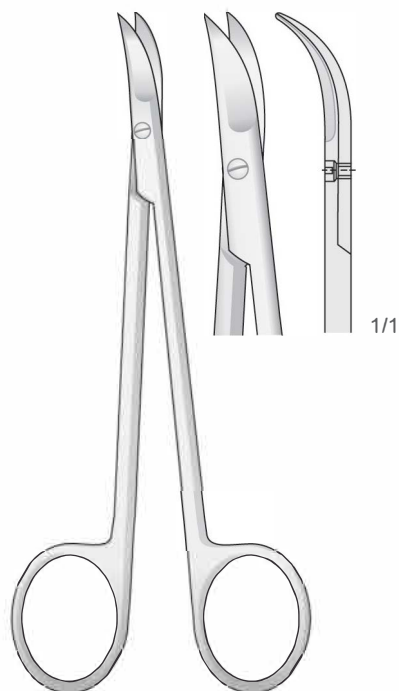

CHADWICK
WI-10468
115 mm

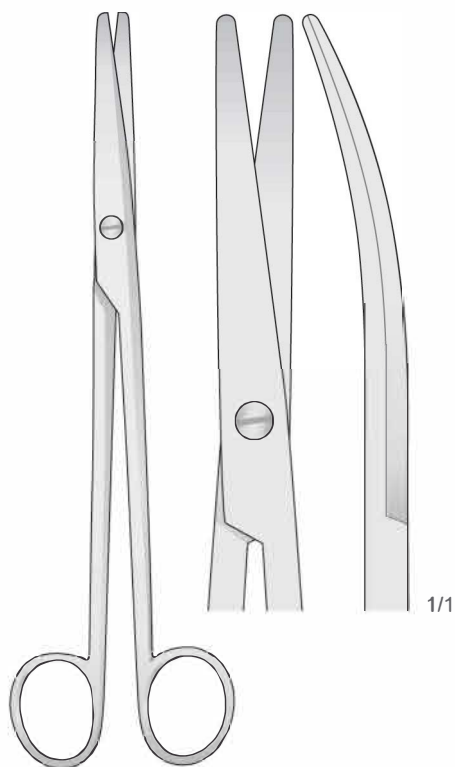

MAYO-LEXER
WI-10469
165 mm

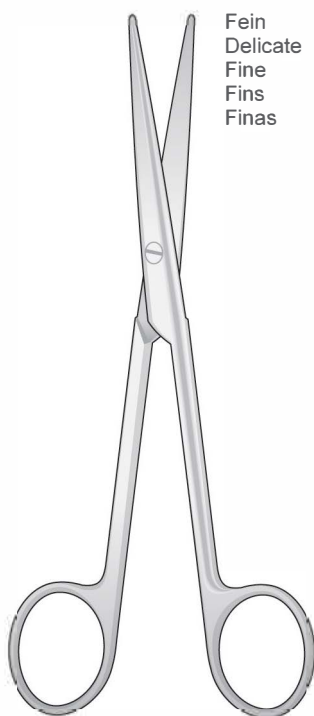

LEXER
WI-10470
165 mm

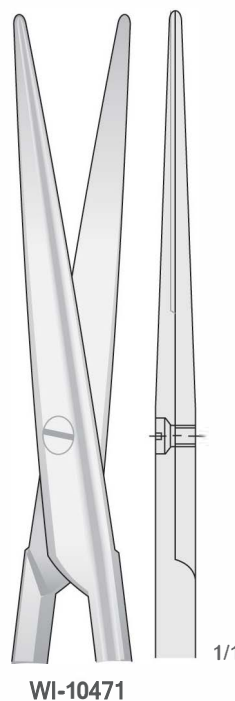

WI-10471



WI-10472



Scheren
Scissors
Forbici
Tijeras
Ciseaux

Stumpf
Blunt
Smusse
Romas
Mousses



WI-10473
145 mm

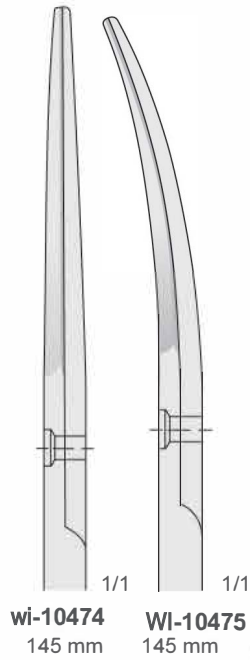

wi-10474 145 mm
WI-10475 145 mm



WI-10476

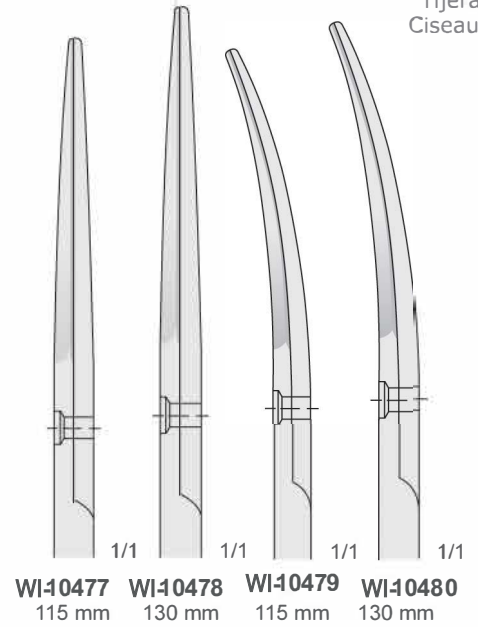

WI-10477 115 mm
WI-10478 130 mm
WI-10479 115 mm
WI-10480 130 mm

Stumpf
Blunt
Smusse
Romas
Mousses

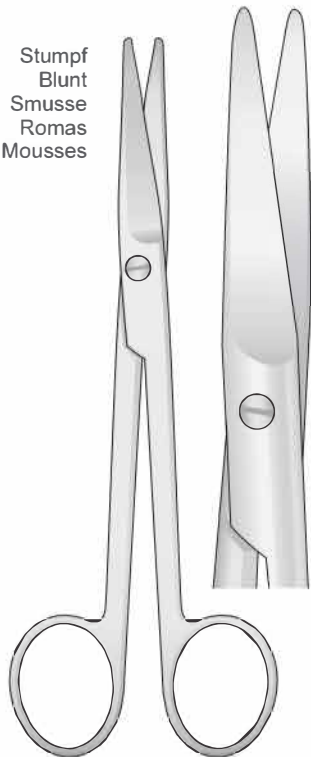

MAYO
WI-10477
140 mm

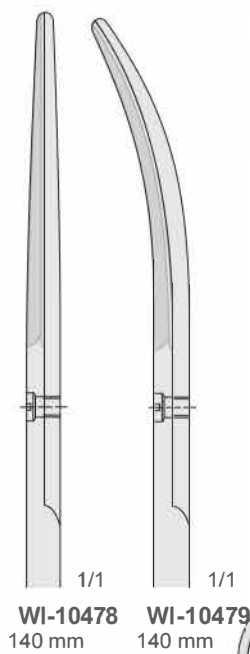

WI-10478 140 mm
WI-10479 140 mm

Spitz
Sharp
Acute
Agudo
Pointu



WI-10484

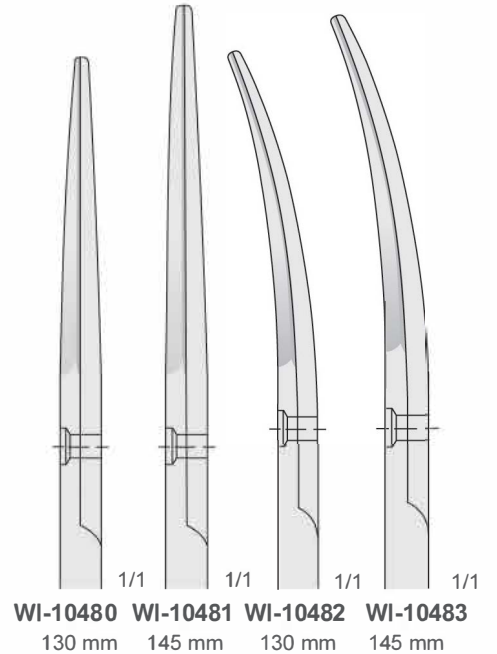

WI-10480 130 mm
WI-10481 145 mm
WI-10482 130 mm
WI-10483 145 mm



Scheren
Scissors
Forbici
Tijeras
Ciseaux

SUPER CUT

Regular Edge **SUPER CUT Edge**

Super Cut Scissors have specially designed cutting edges.
One regular edge and **one sharp-knife edge**.

Extremely Sharp Razor Edge / Atraumatic
Extrem Scharfe Spitzer Beck / Atraumatische
Tranchant extrêmement aiguisée / Atraumatique
Borde extremadamente afilado / Atraumática
Taglio estremamente affilato / Atraumatica

One side serrated
Eine seite gezahnt
Un côté dentelé
Un lado dentado
Un lato dentellato

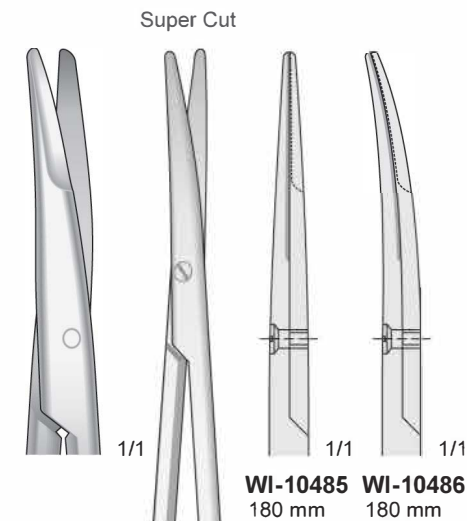

METZENBAUM
WI-10491
180 mm

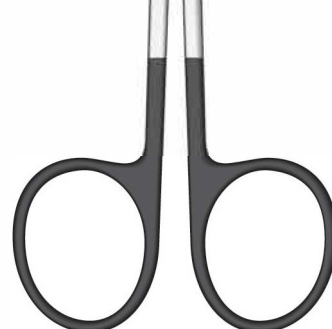

METZENBAUM
WI-10492
125 mm



STEVENS
WI-10493
125 mm



Scheren
Scissors
Forbici
Tijeras
Ciseaux

Fein
Delicate
Fine
Finas
Fins



WI-10494
115 mm

WI-10495
115 mm

BABY - METZENBAUM
WI-10498
115 mm

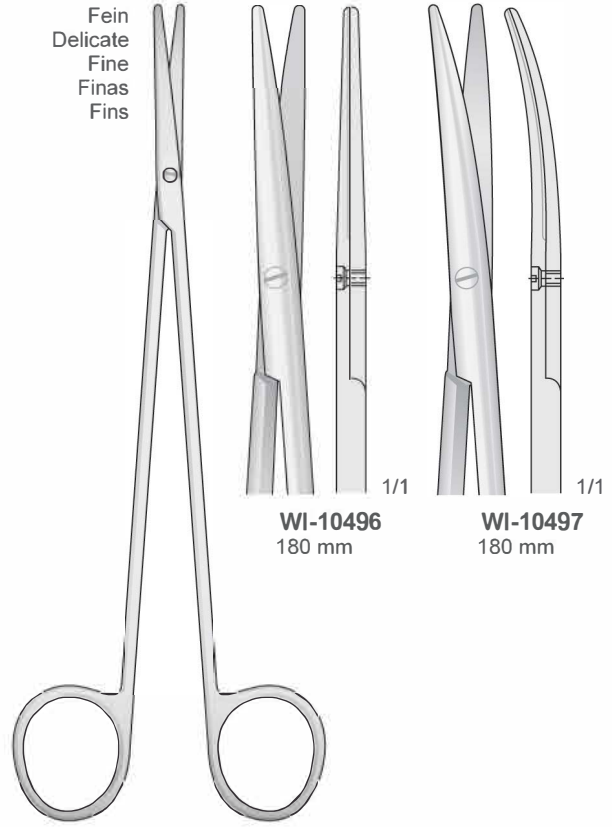

WI-10496
180 mm

WI-10497
180 mm

TOENNIS-ADSON
WI-10499
180 mm

Präparierscheren - Dissecting Scissors
Forbici per dissezione - Tijeras de disección - Ciseaux à dissection

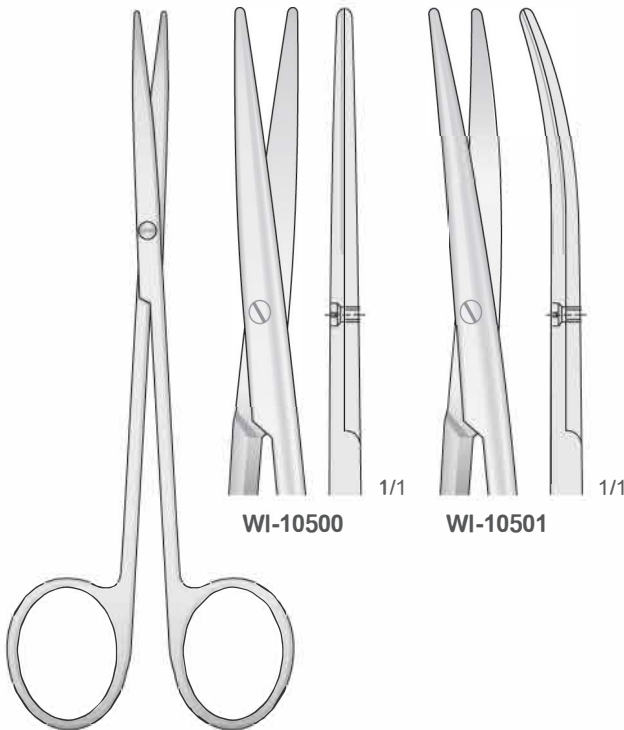

WI-10500

WI-10501

METZENBAUM
WI-10504
145 mm



WI-10502

WI-10503

METZENBAUM-FINO
WI-10505
145 mm



Scheren
Scissors
Forbici
Tijeras
Ciseaux

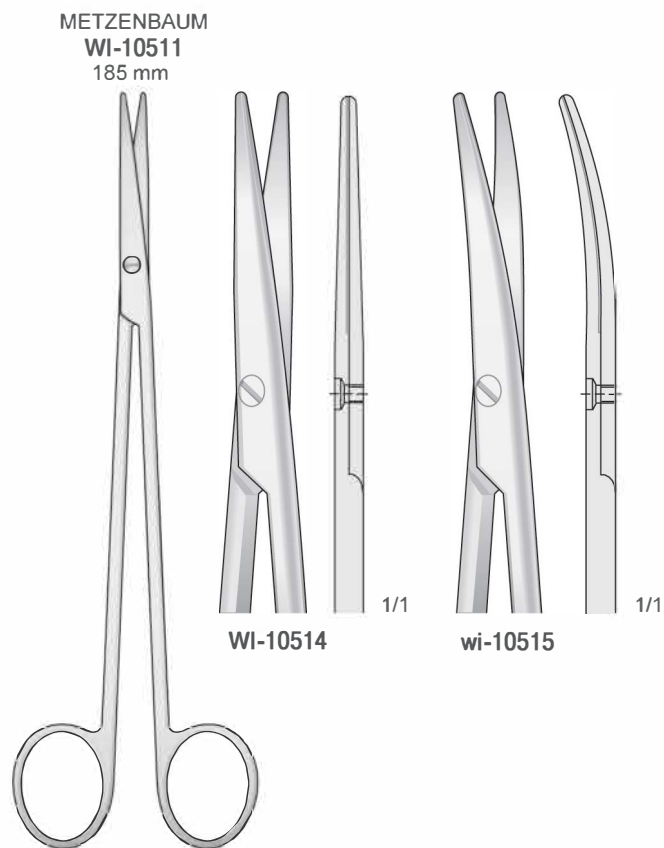
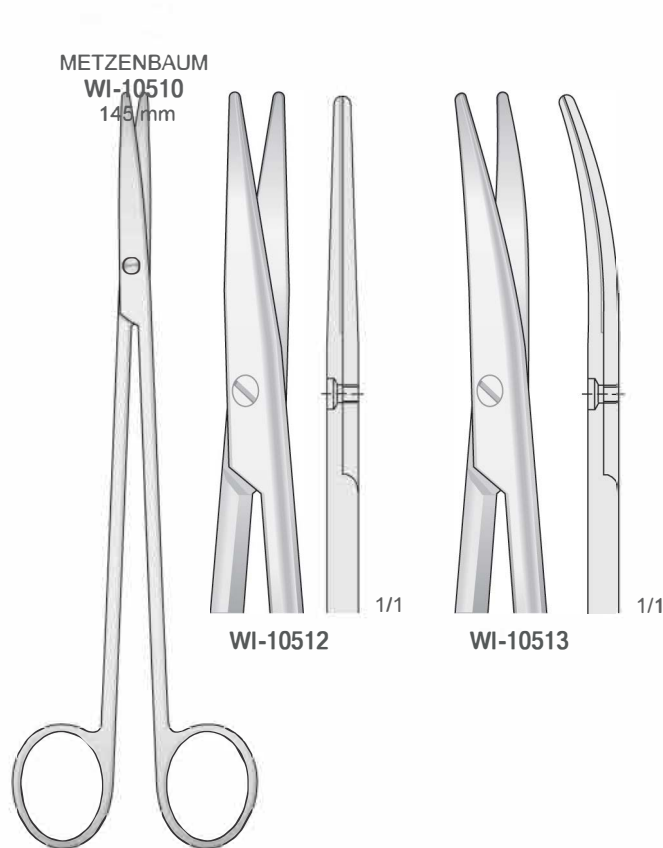
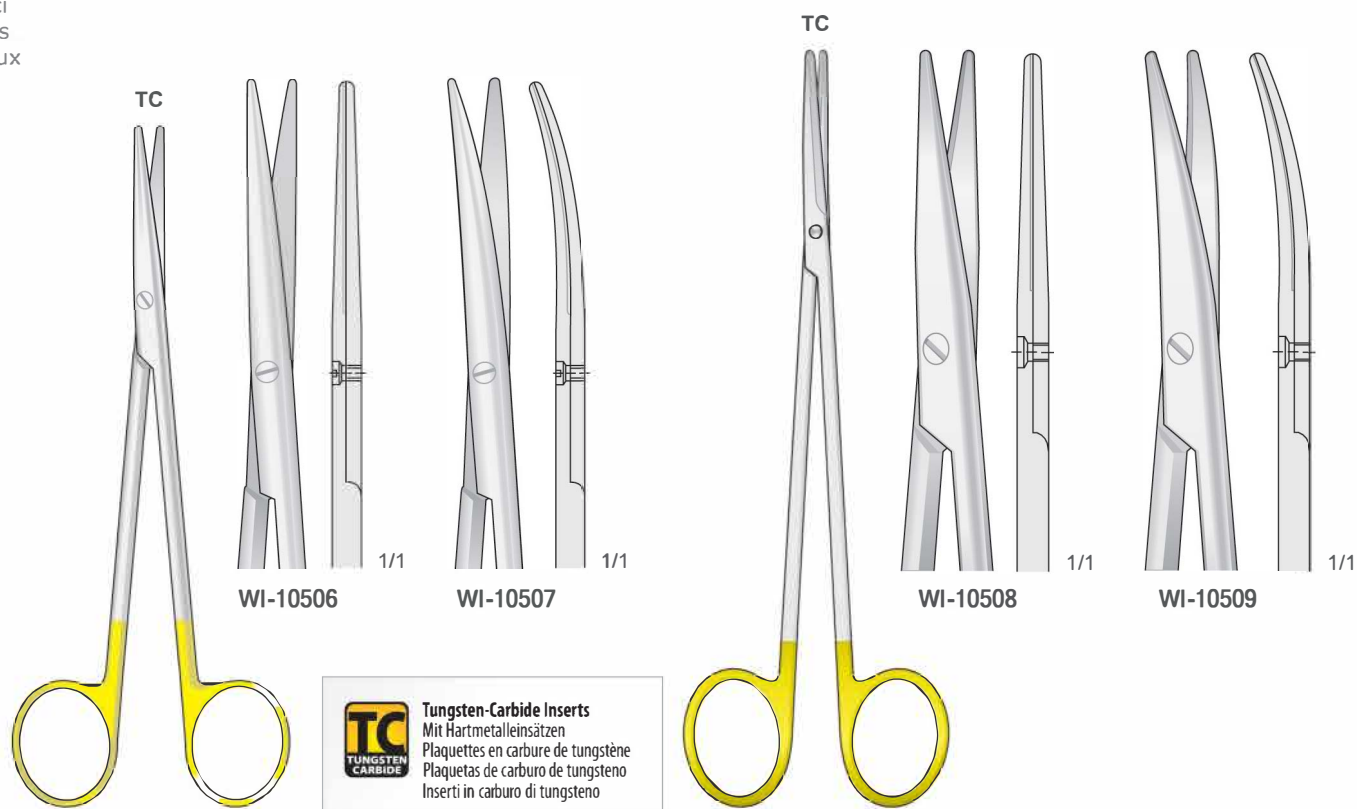

METZENBAUM
WI-10516
185 mm

185 mm
METZENBAUM-FINO
WI-10517



Scheren
Scissors
Forbici
Tijeras
Ciseaux

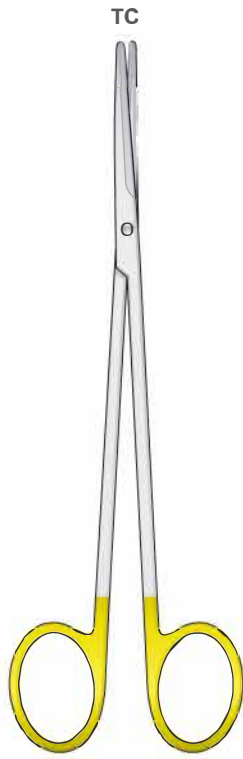

METZENBAUM-FINO
wi-10522

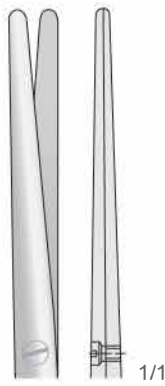

wi-10518
140 mm

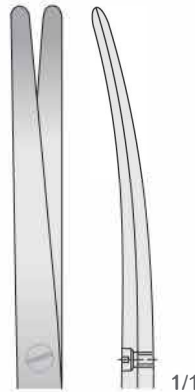

wi-10519
140 mm

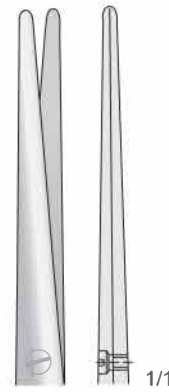

wi-10520
180 mm

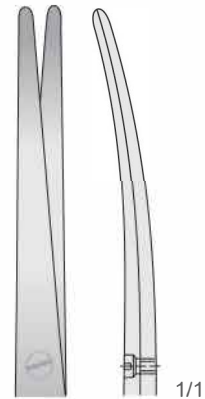

wi-10521
180 mm

Tungsten-Carbide Inserts
Mit Hartmetalleinsätzen
Plaquettes en carbure de tungstène
Plaquetas de carburo de tungsteno
Inserti in carburo di tungsteno

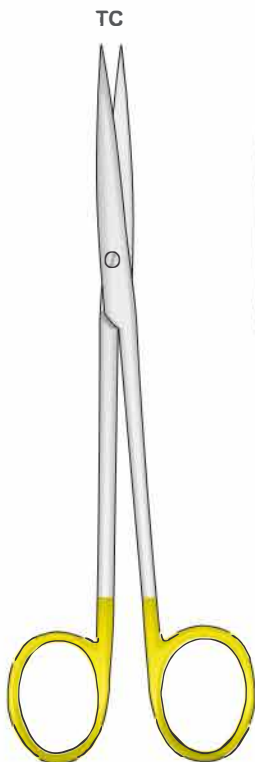

METZENBAUM-FINO
wi-10527

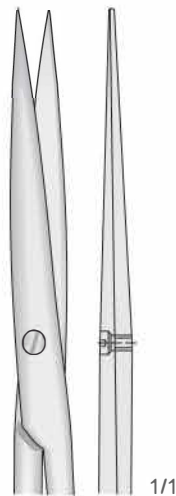

wi-10523
140 mm

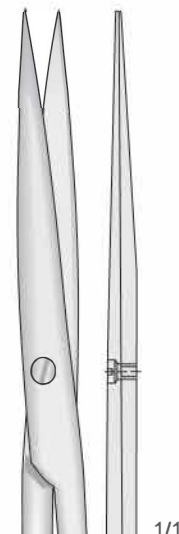

wi-10524
180 mm

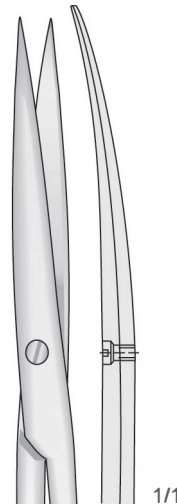

wi-10525
140 mm



wi-10526
180 mm



Scheren
Scissors
Forbici
Tijeras
Ciseaux



Tungsten-Carbide Inserts
Mit Hartmetalleinsätzen
Plaquettes en carbure de tungstène
Plaquetas de carburo de tungsteno
Inserti in carburo di tungsteno

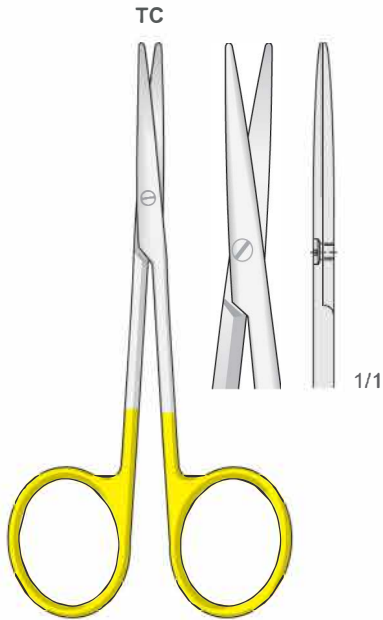

LEXER-BABY (KNAPP)
wi-10528
115 mm

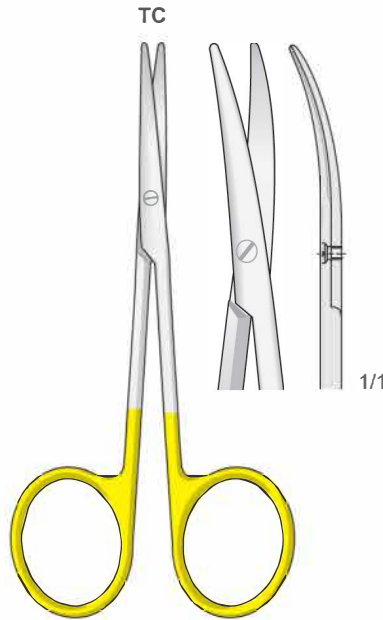

LEXER-BABY (KNAPP)
wi-10529
115 mm

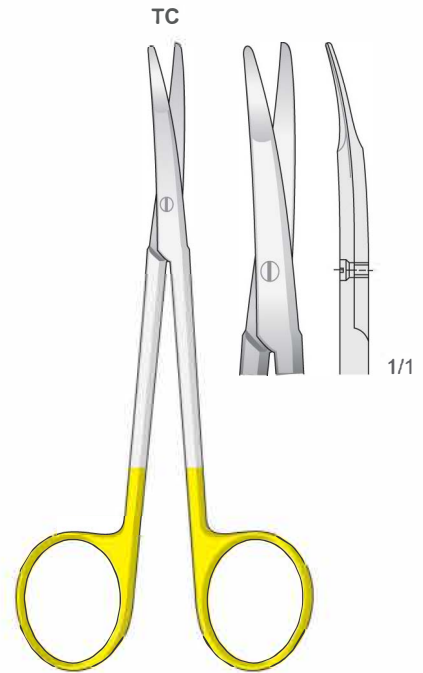

KILNER
wi-10530
125 mm

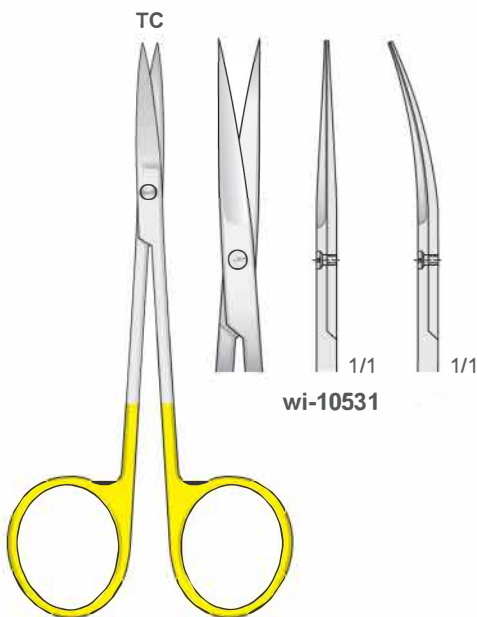

wi-10534
115 mm

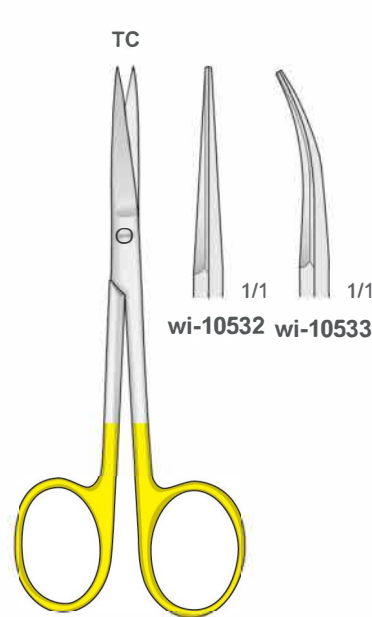

wi-10535
110 mm

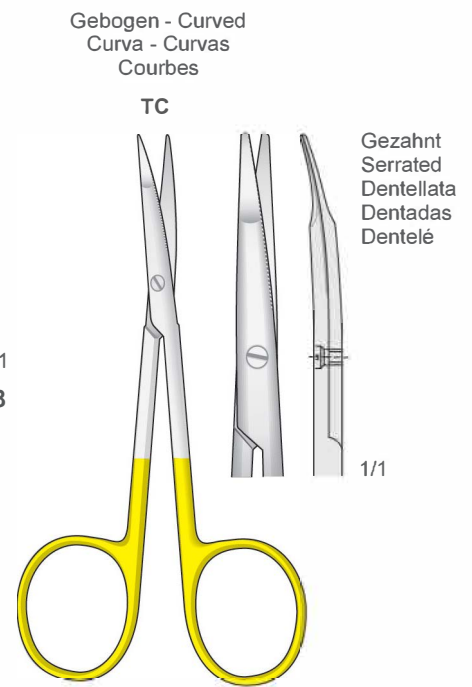

GREENBERG-PAR
wi-10536
115 mm



Scheren
Scissors
Forbici
Tijeras
Ciseaux



TC

1/1

Gezahnt
Serrated
Dentellate
Dentadas
Dentelé

wi-10537
160 mm
Super Cut

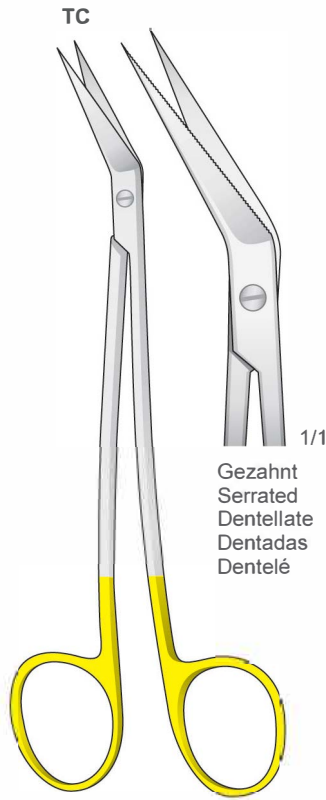

TC

1/1

Gezahnt
Serrated
Dentellate
Dentadas
Dentelé

wi-10538
160 mm

Tungsten-Carbide Inserts
Mit Hartmetalleinsätzen
Plaquettes en carbure de tungstène
Plaquetas de carburo de tungsteno
Inserti in carburo di tungsteno

Eine Schneide gezahnt S-förmig gebogen
One toothed cutting edge S-shaped
Una lama dentata curva a forma S
Una hoja dentada forma S
Une lame dentelée courbés en S

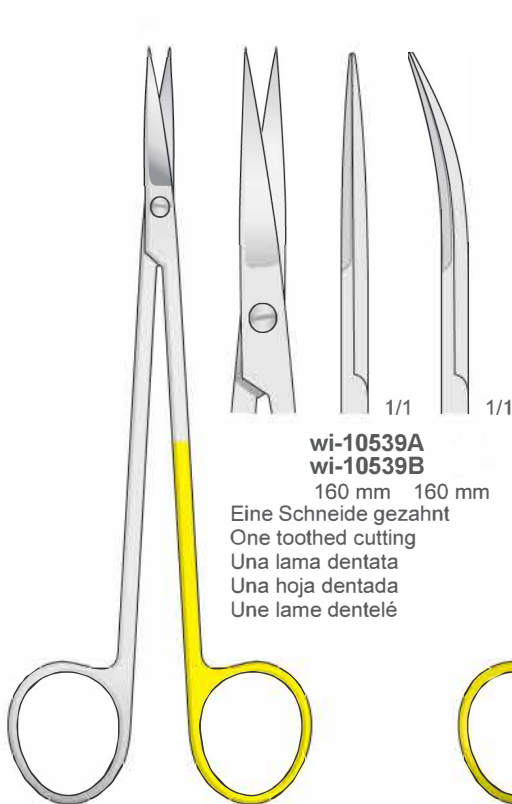

TC

1/1 1/1

wi-10539A
wi-10539B
160 mm 160 mm
Eine Schneide gezahnt
One toothed cutting
Una lama dentata
Una hoja dentada
Une lame dentelé

KELLY
wi-10539
160 mm

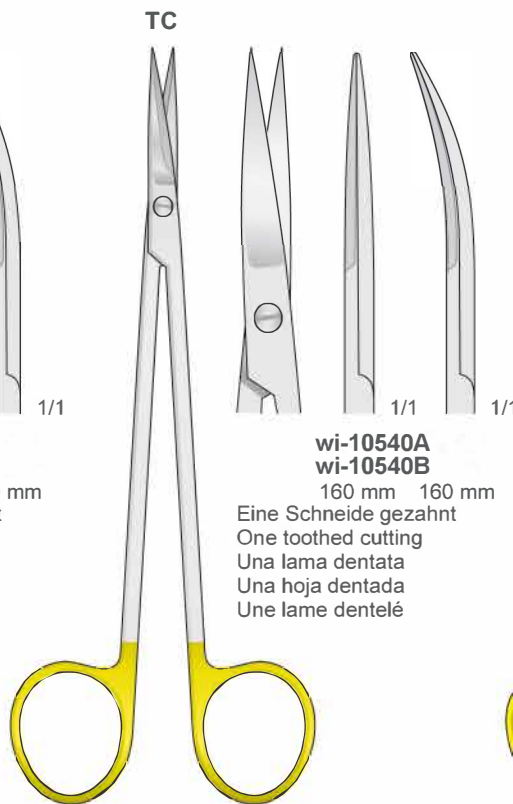

1/1 1/1

wi-10540A
wi-10540B
160 mm 160 mm
Eine Schneide gezahnt
One toothed cutting
Una lama dentata
Una hoja dentada
Une lame dentelé

KELLY
wi-10540
160 mm

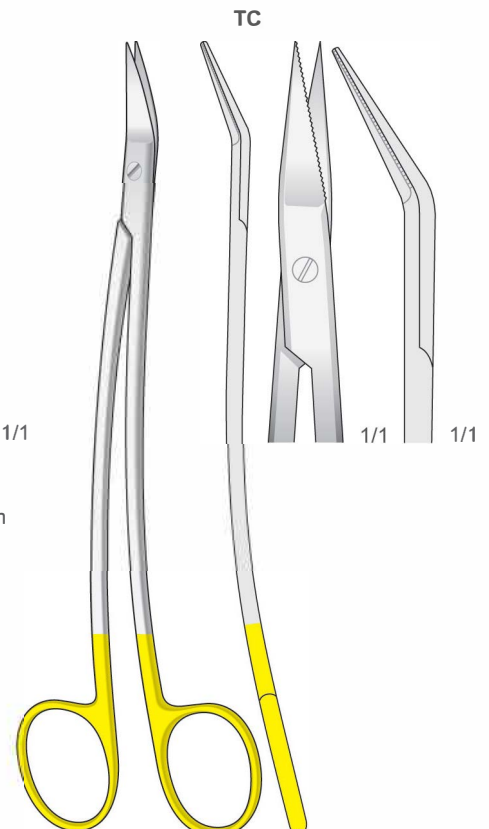

TC

1/1 1/1

wi-10541
175 mm



Scheren
Scissors
Forbici
Tijeras
Ciseaux

Wellenschliff
TC

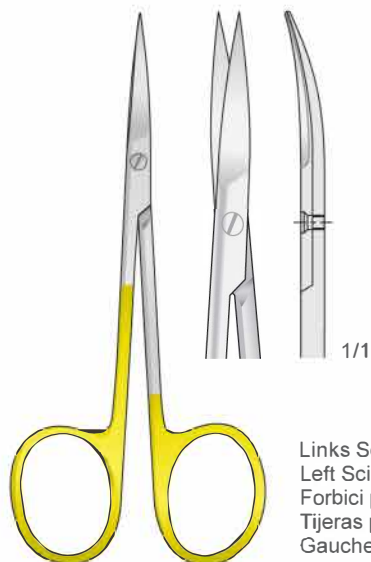

Links Scheren
Left Scissors
Forbici per mancini
Tijeras para zurdos
Gauche Ciseaux



Tungsten-Carbide Inserts
Mit Hartmetalleinsätzen
Plaquettes en carbure de tungstène
Plaquetas de carburo de tungsteno
Inserti in carburo di tungsteno

IRIS
wi-10541A
110 mm

Wellenschliff
TC

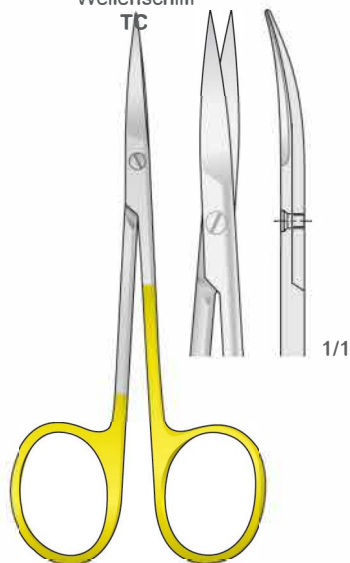

IRIS
wi-10542
110 mm

Wellenschliff
TC

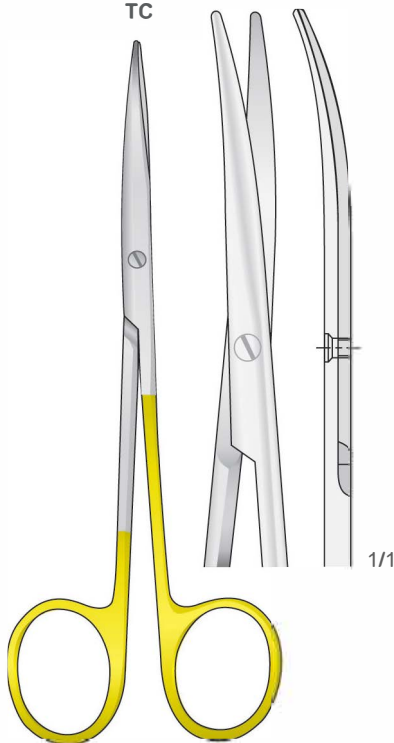

METZENBAUM
wi-10543
145 mm

Wellenschliff
TC

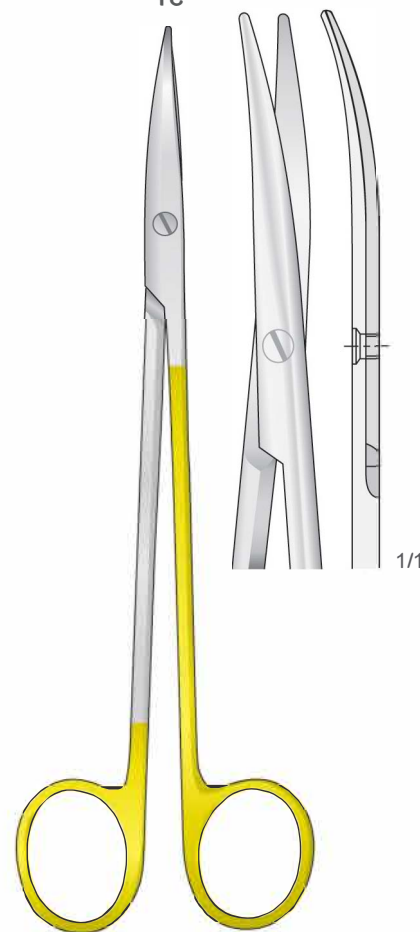

METZENBAUM
wi-10544
185 mm



Scheren
Scissors
Forbici
Tijeras
Ciseaux



Extremely Sharp Razor Edge / Atraumatic
Extrem Scharfe Spitzer Beck / Atraumatische
Tranchant extrêmement aiguisée / Atraumatique
Borde extremadamente afilado / Atraumática
Taglio estremamente affilato / Atraumatica

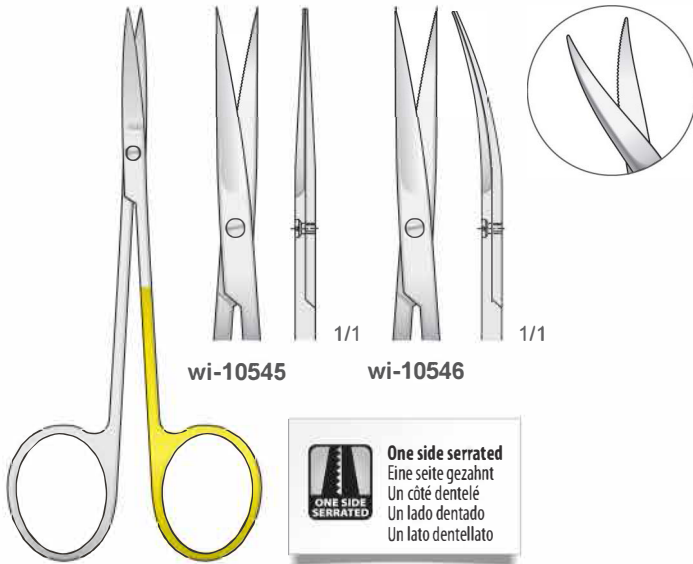

wi-10545

wi-10546



One side serrated
Eine seite gezahnt
Un côté dentelé
Un lado dentado
Un lato dentellato

wi-10547
110 mm

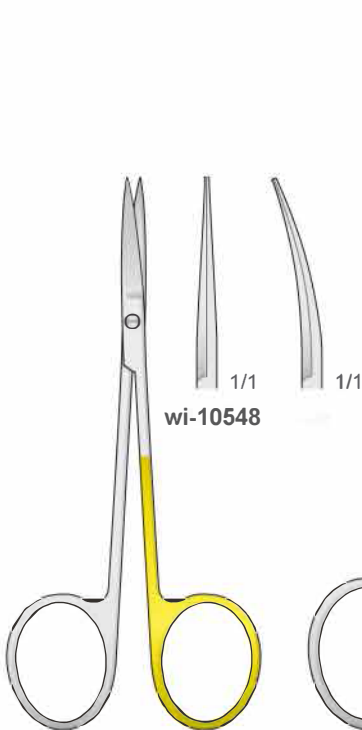

wi-10548

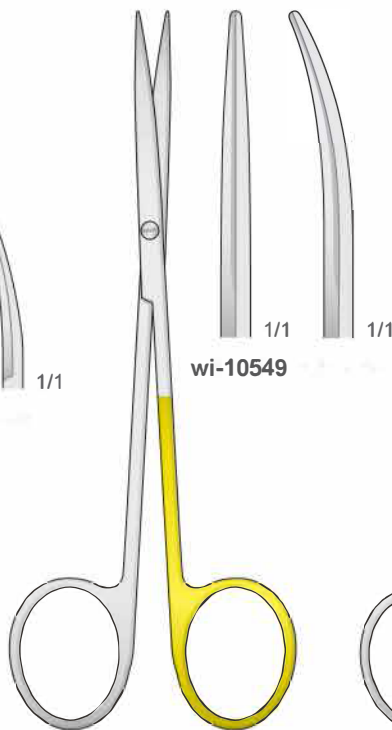

wi-10549

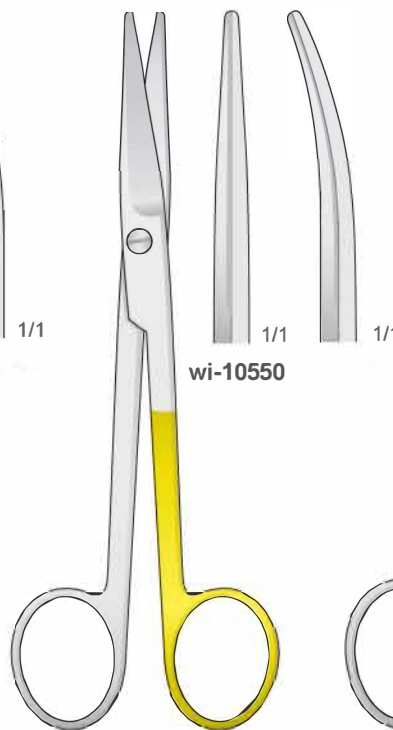

wi-10550

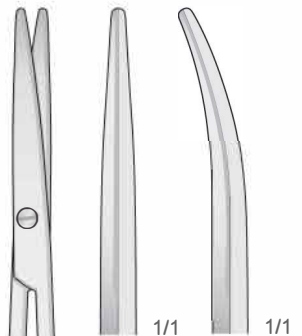

wi-10551

IRIS
wi-10552
110 mm

METZENBAUM
wi-10553
145 mm

MAYO
wi-10554
140 mm

METZENBAUM
wi-10555
185 mm



Scheren
Scissors
Forbici
Tijeras
Ciseaux

SUPER CUT

Regular Edge SUPER CUT Edge

Super Cut Scissors have specially designed cutting edges. One regular edge and **one sharp-knife edge**.

Extremely Sharp Razor Edge / Atraumatic
Extrem Scharfe Spitzer Beck / Atraumatische
Tranchant extrêmement aiguisée / Atraumatique
Borde extremadamente afilado / Atraumática
Taglio estremamente affilato / Atraumatica

One side serrated
Eine seite gezahnt
Un côté dentelé
Un lado dentado
Un lato dentellato

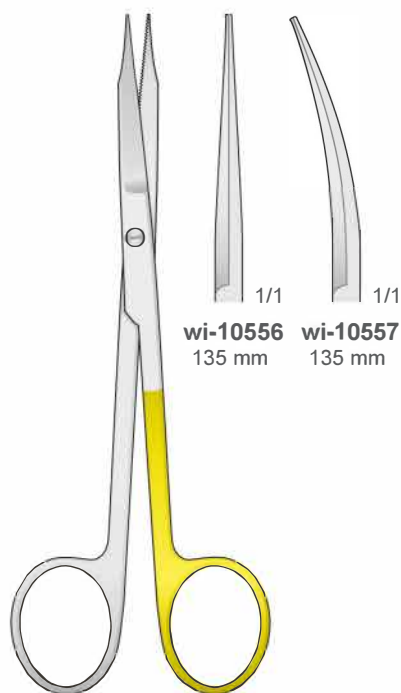

GOLDMAN-FOX
wi-10558
135 mm

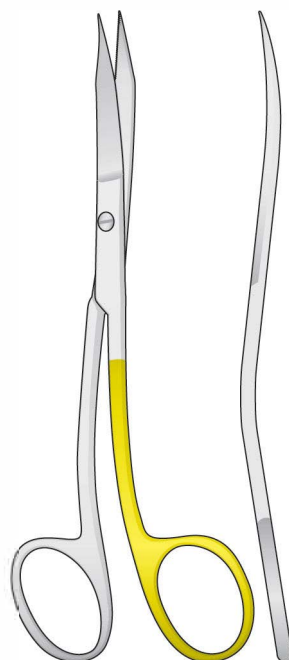

GOLDMAN-FOX S FORM
wi-10559
130 mm

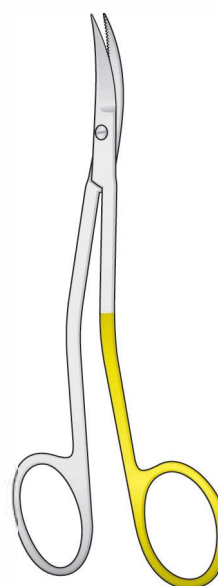

LA GRANGE
wi-10560
115 mm

Spitz
Sharp
Acute
Agudas
Pointu

Stumpf
Blunt
Smusse
Romas
Mousse

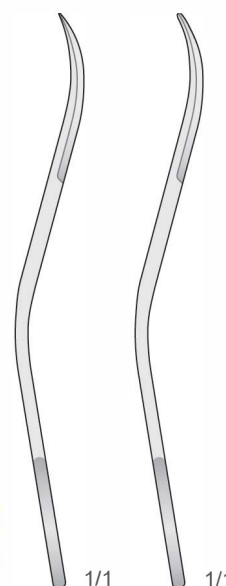

LA GRANGE LA GRANGE
wi-10561



Scheren
Scissors
Forbici
Tijeras
Ciseaux

TC

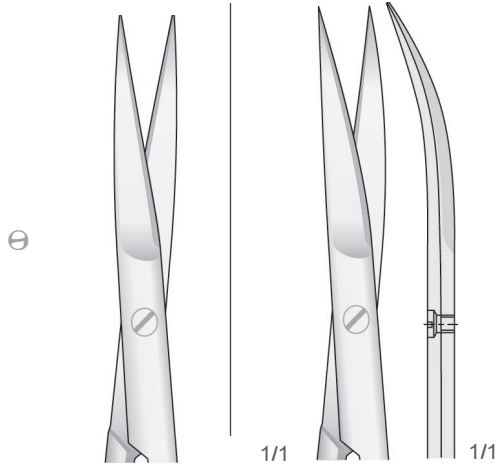

wi-10562
150 mm

wi-10563
150 mm

Tungsten-Carbide Inserts
Mit Hartmetalleinsätzen
Plaquettes en carbure de tungstène
Plaquetas de carburo de tungsteno
Inserti in carburo di tungsteno

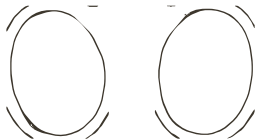

JOSEPH
wi-10564
150 mm

One side serrated
Eine seite gezahnt
Un côté dentelé
Un lado dentado
Un lato dentellato

One side serrated
Eine seite gezahnt
Un côté dentelé
Un lado dentado
Un lato dentellato

TC

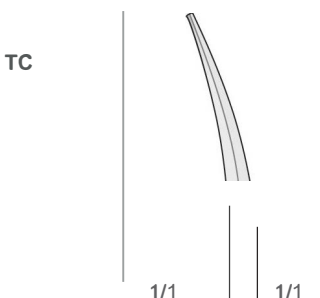

wi-10565 **wi-10565A**

Gezahnt - Serrated
Dentellata - Dentadas
Dentelé

TC

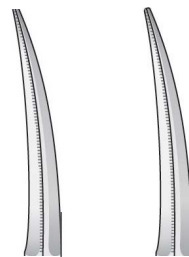

wi-10566
Spitz
Sharp
Acuta
Aguda
Pointu



wi-10567
Stumpf
Blunt
Smussa
Romas
Mousse

TC



1/1

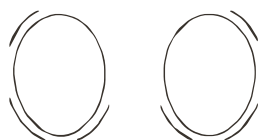

GOLDMAN-FOX
wi-10567A
135 mm

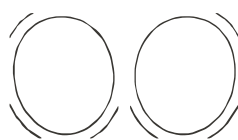

PECK-JOSEPH
wi-10568
140 mm

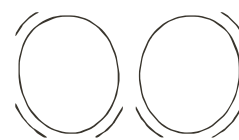

GREGORY
wi-10569



Scheren
Scissors
Forbici
Tijeras
Ciseaux

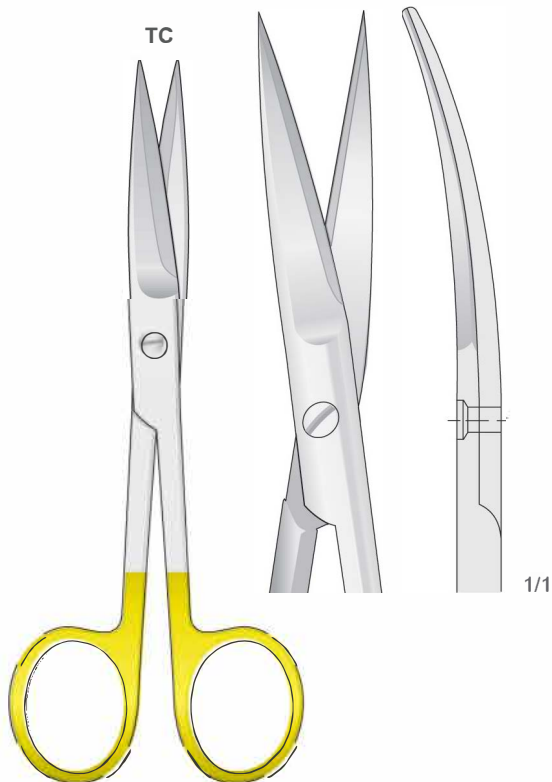

wi-105 70
145 mm

TC
TUNGSTEN
CARBIDE

Tungsten-Carbide Inserts
Mit Hartmetalleinsätzen
Plaquettes en carbure de tungstène
Plaquetas de carburo de tungsteno
Inserti in carburo di tungsteno

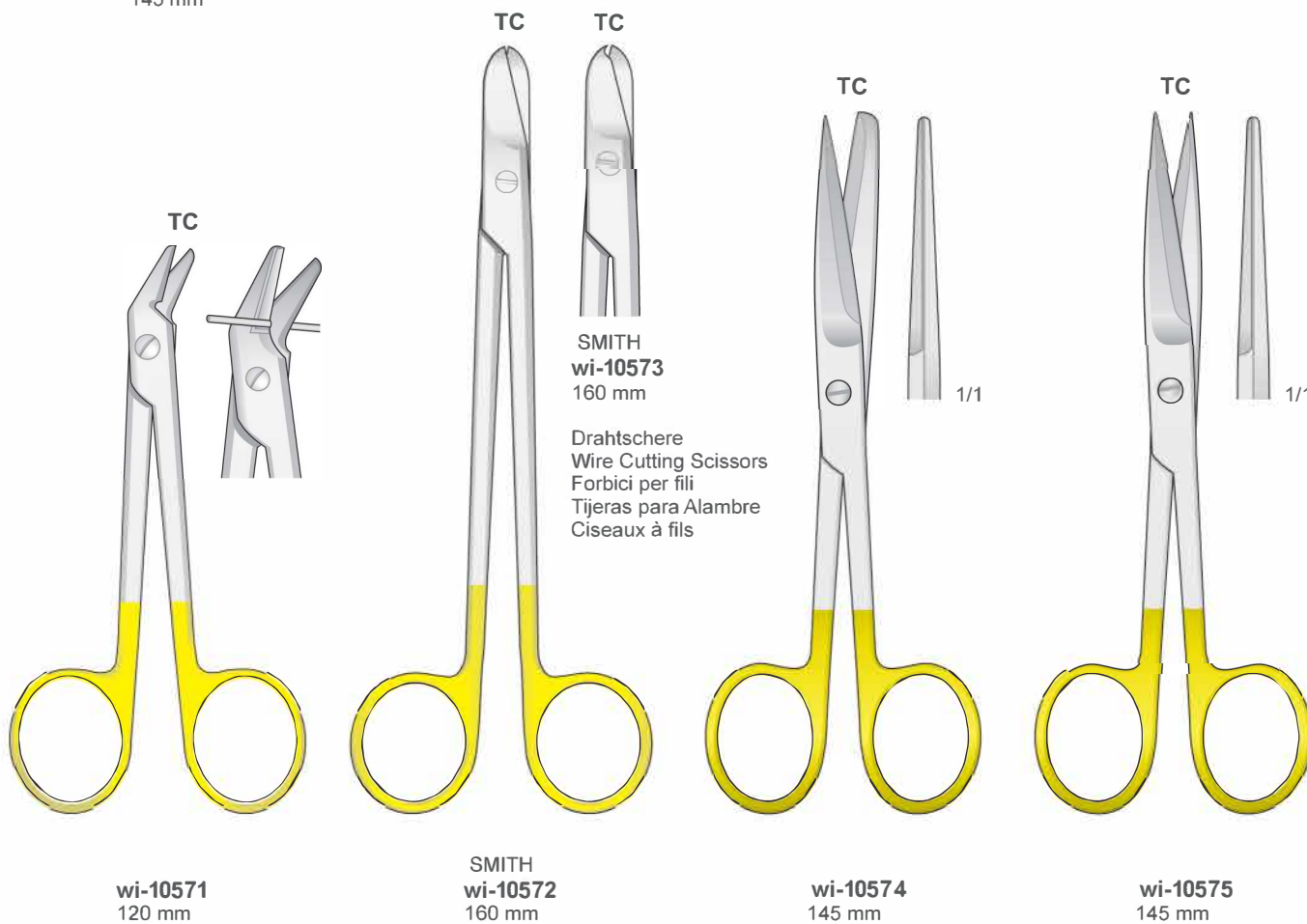

wi-10571
120 mm

SMITH
wi-10572
160 mm

wi-10574
145 mm

wi-10575
145 mm

SMITH
wi-10573
160 mm

Drahtschere
Wire Cutting Scissors
Forbici per fili
Tijeras para Alambre
Ciseaux à fils



Mikro Pinzetten
Delicate Forceps
Micro Pinzette
Pinzas finas
Micro Pincers

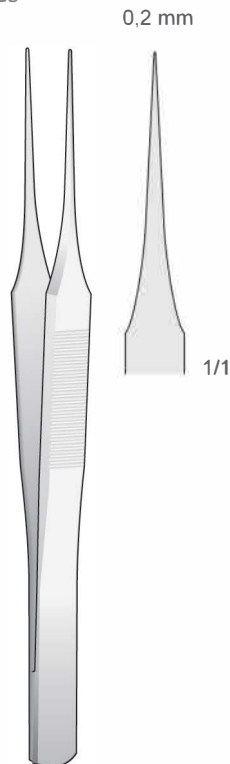

wi-10576
110 mm

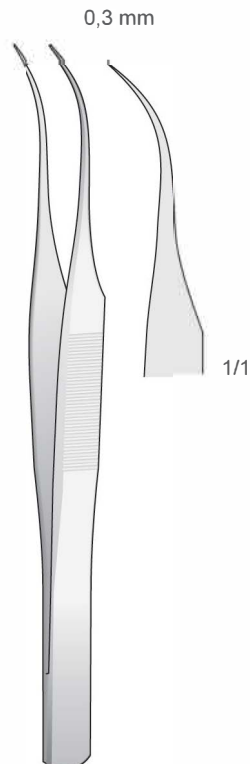

wi-10577
110 mm

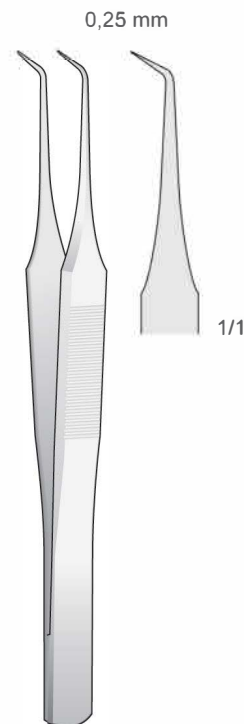

wi-10578
100 mm

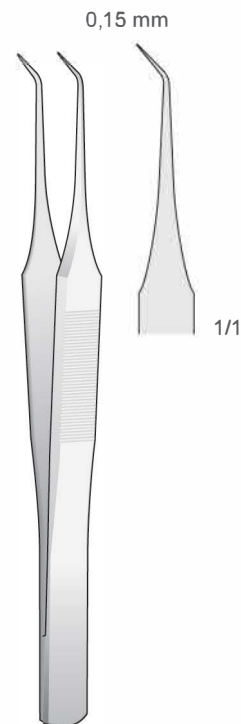

wi-10579
100 mm

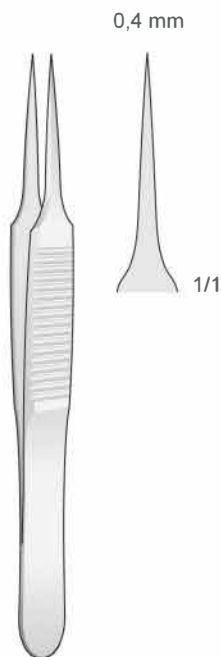

wi-10580
110 mm

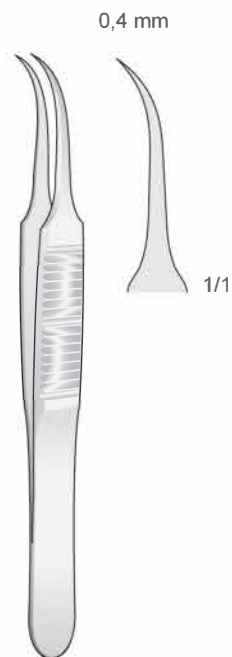

wi-10581
110 mm

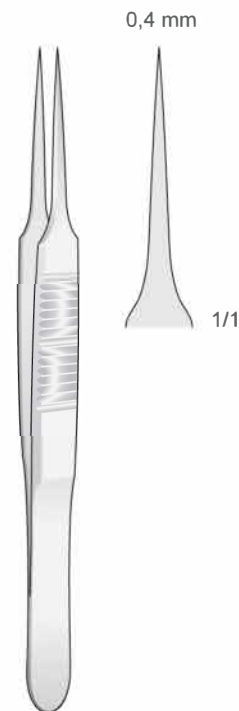

wi-10582
130 mm

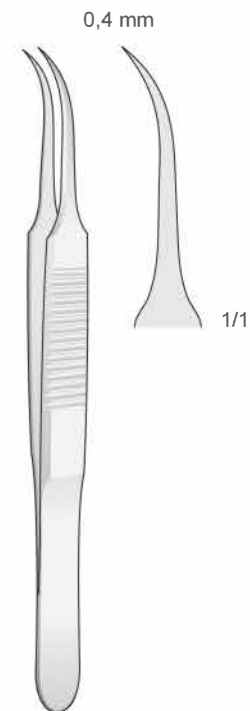

wi-10583
130 mm



Delicate Forceps
Micro Pinzette
Pinzas finas
Micro Pincas



Tissue Forceps
1x2 Teeth

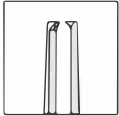

BISHOP-HARMON
wi-10584 1,2
mm 85 mm

Dressing Forceps
criss-cross serrated tips

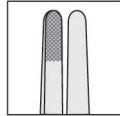

BISHOP-HARMO
N wi-10585 1,2
mm 85 mm

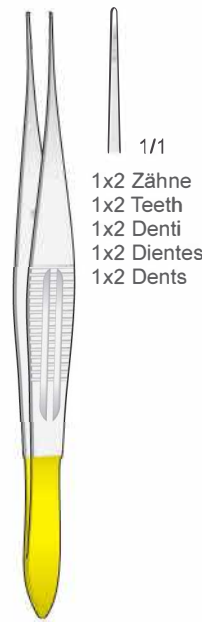

1/1
1x2 Zähne
1x2 Teeth
1x2 Denti
1x2 Dientes
1x2 Dents

CASTROVIEJO
wi-10586 0.9
mm 120 mm

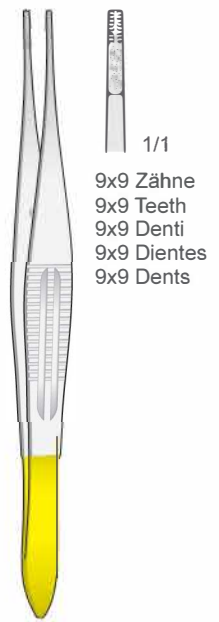

1/1
9x9 Zähne
9x9 Teeth
9x9 Denti
9x9 Dientes
9x9 Dents

BROWN
wi-10587
120 mm

1,2 mm

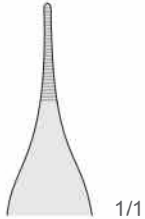
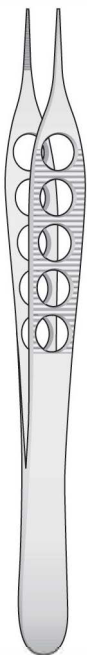

ADSON
wi-10588
120 mm

1,2 mm

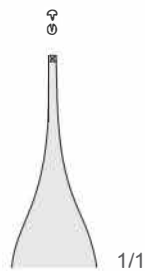
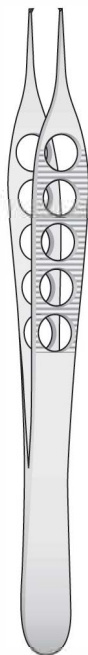

ADSON
wi-10589
120 mm

©

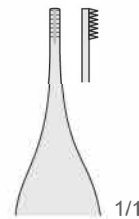
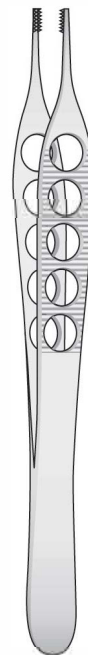

1/1
7x7 Zähne
7x7 Teeth
7x7 Denti
7x7 Dientes
7x7 Dents

ADSON-BROWN
wi-10590
120 mm

TC

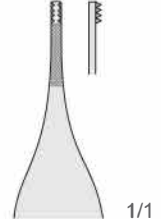

ADSON-BROWN
wi-10591
120 mm



Mikro Pinzetten
 Delicate Forceps
 Micro Pinzette
 Pinzas finas
 Micro Pincers

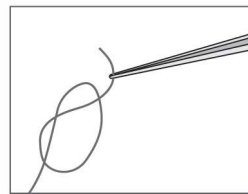

wi-10598
120 mm

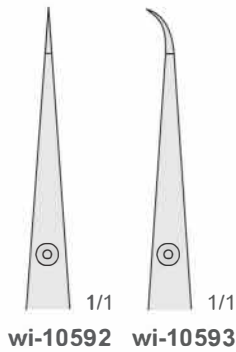

wi-10592 1/1
wi-10593 1/1



wi-10599
150 mm

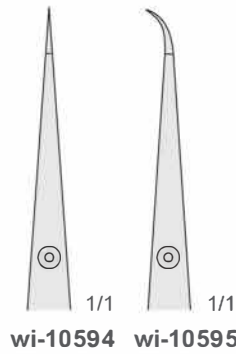

wi-10594 1/1
wi-10595 1/1

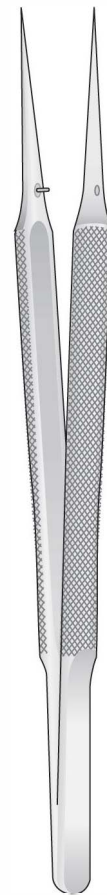

wi-10600
180 mm

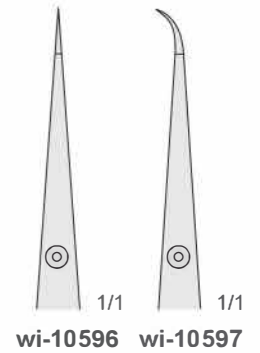

wi-10596 1/1
wi-10597 1/1



Mikro Pinzette - Rundgriff Ø 8 mm
Mit Führungsstift diamantiert
Fadenplatte 6x0,7 mm

Mikro Pinzetten
Micro Forceps
Micro Pinzette
Micro Pinzas
Micro Pincers

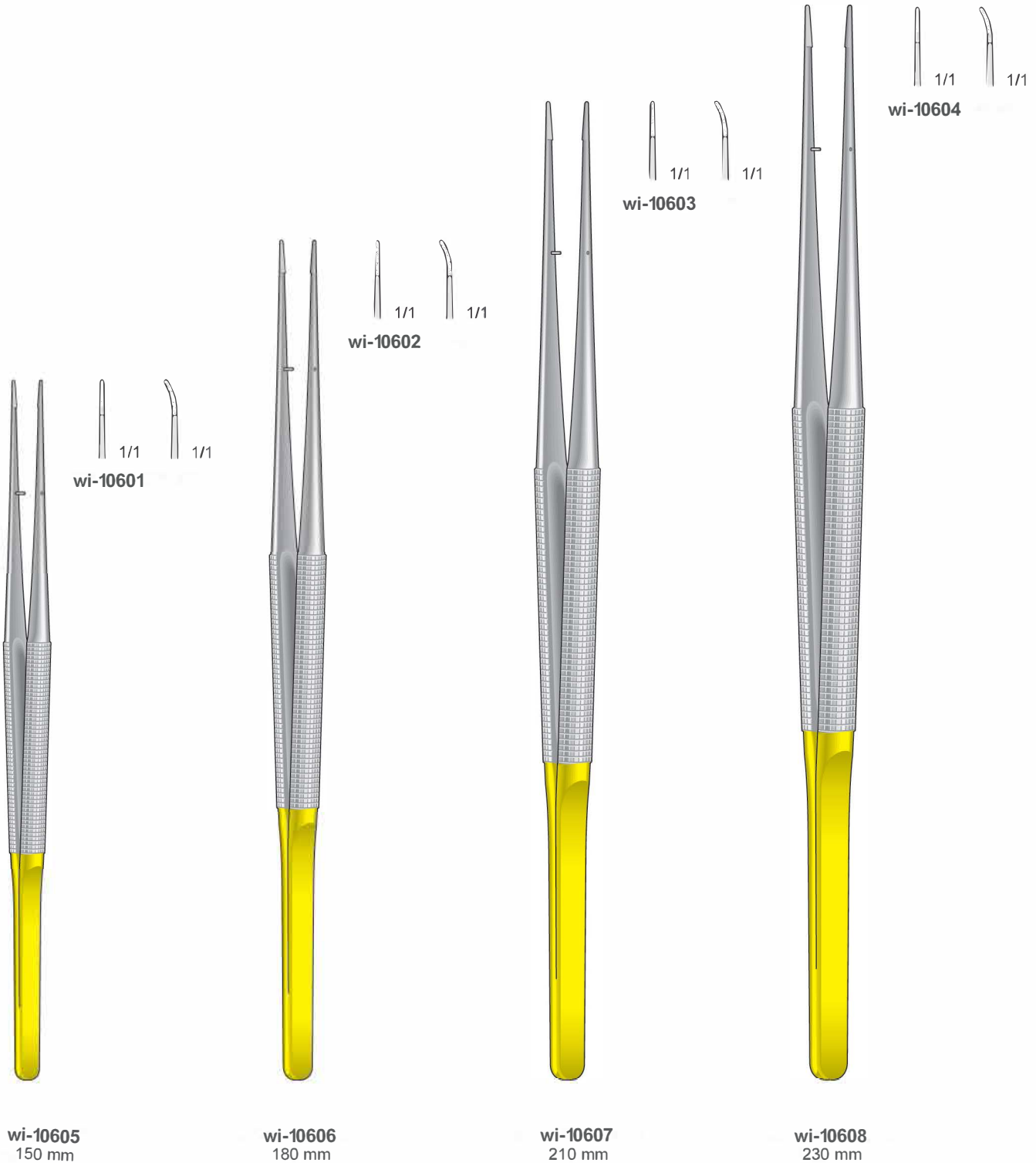

wi-10605
150 mm

wi-10606
180 mm

wi-10607
210 mm

wi-10608
230 mm







Mikro Pinzetten
Micro Forceps
Micro Pinzette
Micro Pinzas
Micro Pincers

Mikro Pinzette - Rundgriff Ø 8 mm
Mit Führungsstift diamantiert
Fadenplatte 6x0,7 mm



Diamond Tip
Diamantiert
Punta diamantata
Punta de diamante
Pointe de diamant

<p>1x2 Zähne 1x2 Teeths 1x2 Denti 1x2 Dientes 1x2 Dents</p>  <p>wi-10609</p>	<p>1x2 Zähne 1x2 Teeths 1x2 Denti 1x2 Dientes 1x2 Dents</p>  <p>wi-10610</p>	<p>1x2 Zähne 1x2 Teeths 1x2 Denti 1x2 Dientes 1x2 Dents</p>  <p>wi-10611</p>	<p>1x2 Zähne 1x2 Teeths 1x2 Denti 1x2 Dientes 1x2 Dents</p>  <p>wi-10612</p>
<p>wi-10613 150 mm</p>	<p>wi-10614 180 mm</p>	<p>wi-10615 210 mm</p>	<p>wi-10616 230 mm</p>



Titan-Pinzetten
Titanium Tissue Forceps
Pinzette in titanio
Pinzas de titanio
Pinces en titane

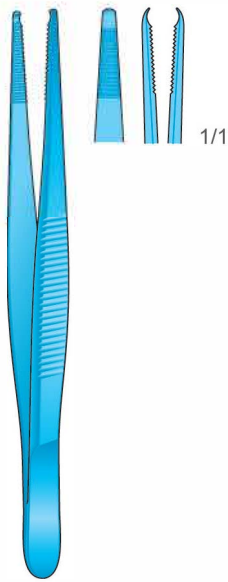

wi-10617
90 mm



wi-10618
130 mm

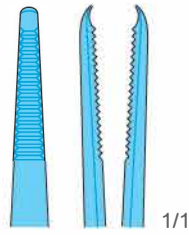

ADSON
wi-10619
120 mm

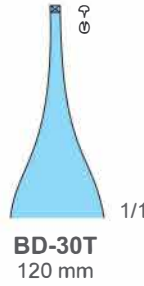

1/1

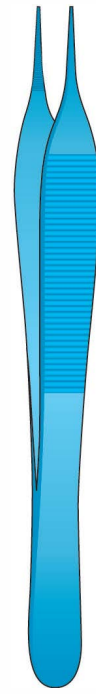

ADSON
wi-10620
120 mm

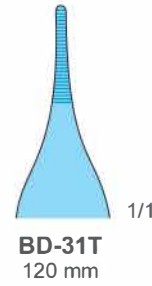

1/1

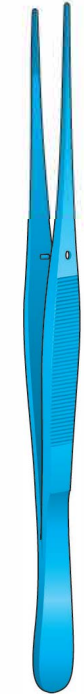

wi-10621
130 mm

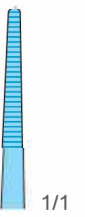

1/1



GERALD
wi-10626
180 mm

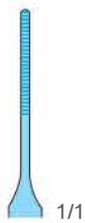

1/1

wi-10622
180 mm

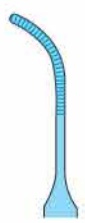

1/1

wi-10623
180 mm



DE BAKEY
wi-10627



1/1

wi-10624
160 mm



1/1

wi-10625
160 mm



COLLEGE
wi-10628
150 mm



wi-10629
145 mm



1/1



Mikro Pinzetten
Delicate Forceps
Micro Pinzette
Pinzas finas
Micro Pincers

Rund-Griffe Ø 8 mm
Round handle Ø 8 mm
Manico rotondo Ø 8 mm
Mango redondo Ø 8 mm
Manche rond Ø 8 mm



Ø 1 mm
wi-10630 - 150 mm
wi-10631 - 180 mm
wi-10632 210 mm

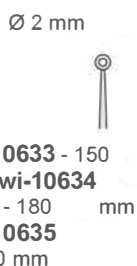

Ø 2 mm
wi-10633 - 150 mm
wi-10634 - 180 mm
wi-10635 - 210 mm

Titan
Titanium
Titanio
Titanio
Titane

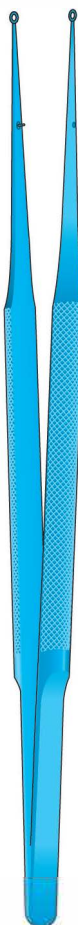

Ø 1 mm
wi-10640A - 150 mm
wi-10640B - 180 mm
wi-10640C - 210 mm

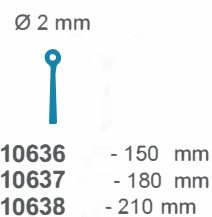

Ø 2 mm
wi-10636 - 150 mm
wi-10637 - 180 mm
wi-10638 - 210 mm



wi-10639

wi-10640



Zahnpinzetten
Cotton and Dressing Pliers
Pinzette per medicazione
Pinzas para vendajes
Précèlles pour cotton

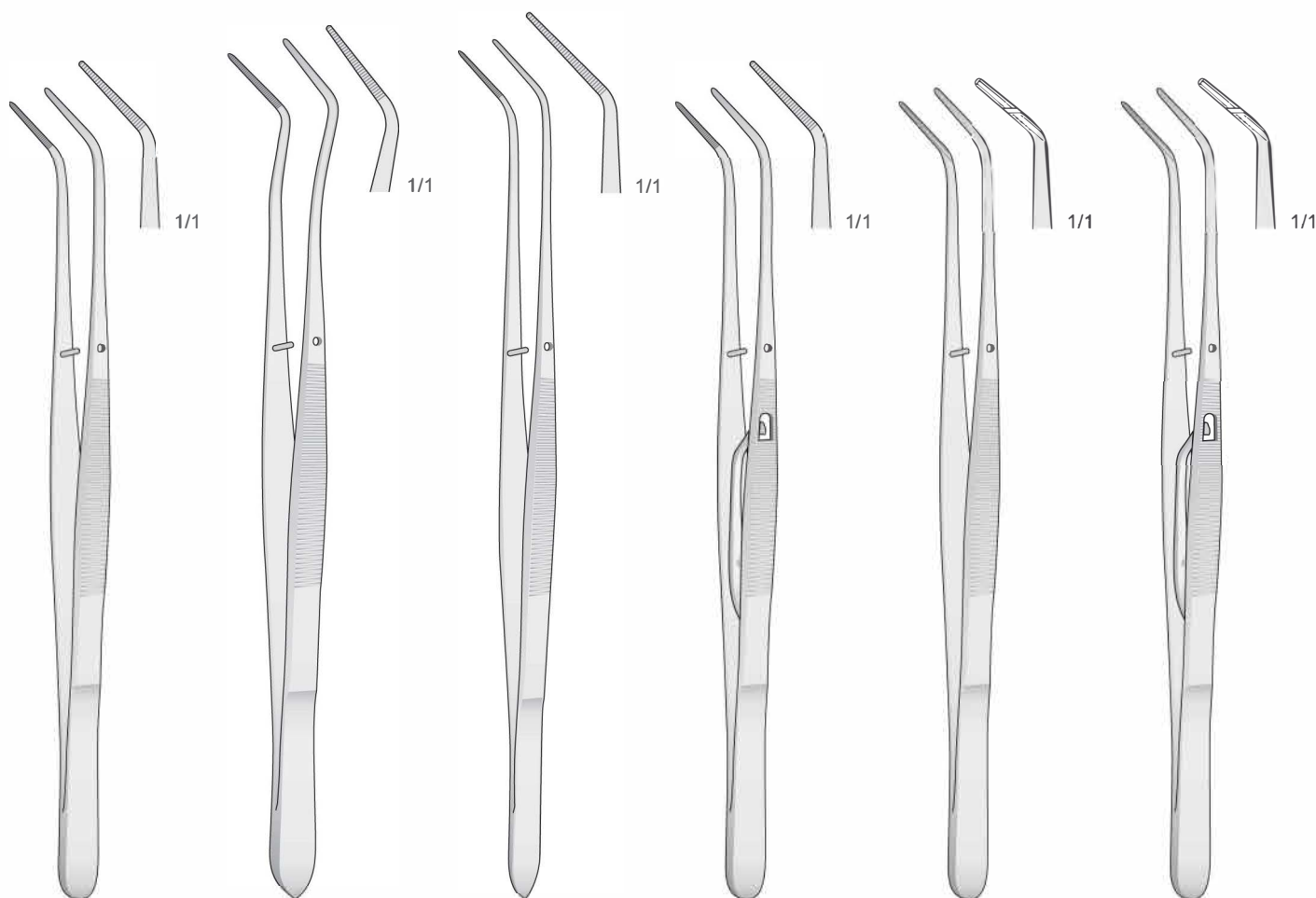

wi-10641
150 mm

wi-10642
160 mm

wi-10643
160 mm

wi-10644
150 mm

wi-10645
150 mm

wi-10646
150 mm



Zahnpinzetten
 Cotton and Dressing Pliers
 Pinzette per medicazione
 Pinzas para vendajes
 Précelles pour coton

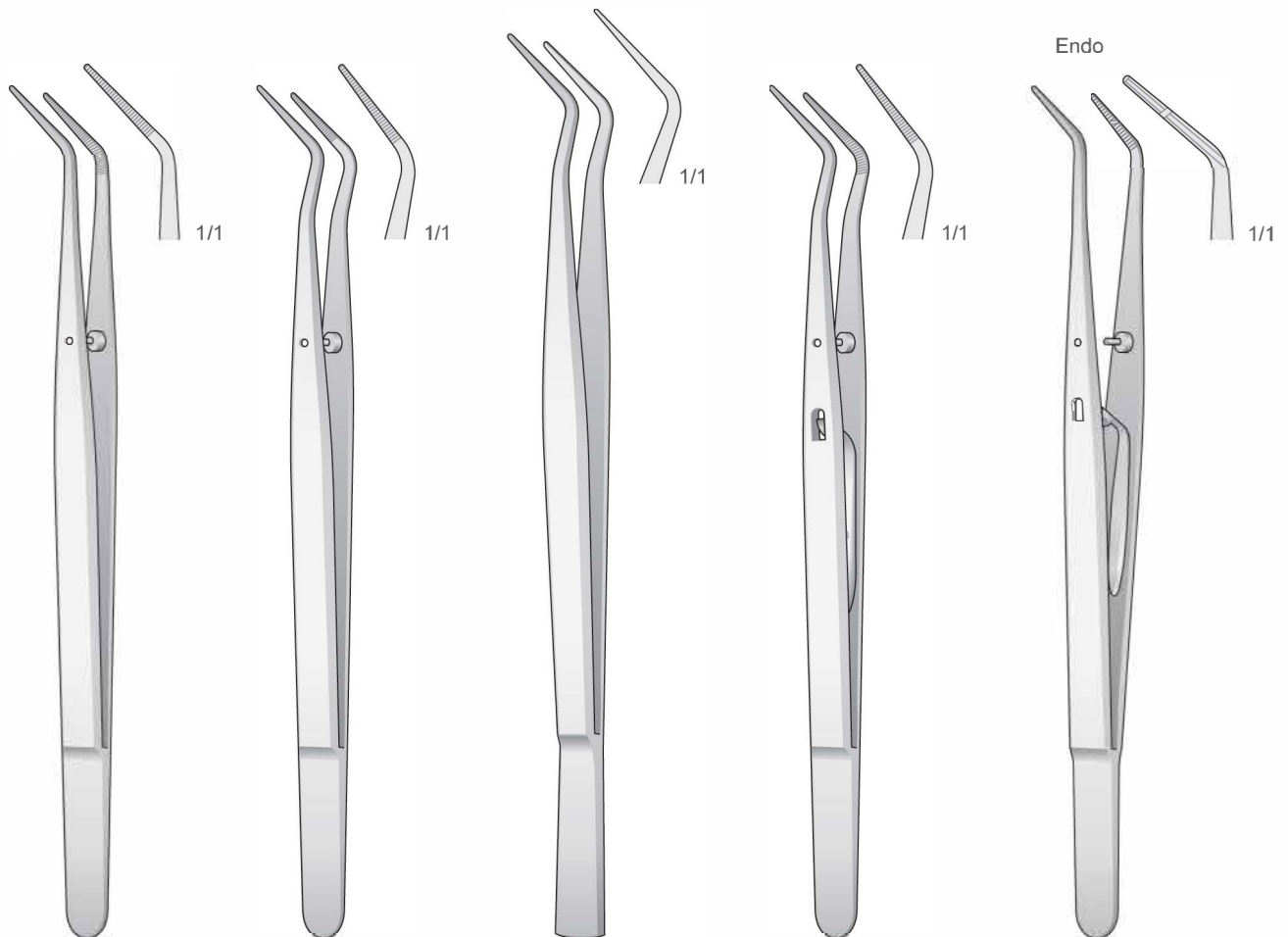

COLLEGE
 wi-10647
 150 mm

MERIAM
 wi-10648
 150 mm

CAULK
wi-10649
 160 mm

LOCKING
 wi-10650
 150 mm

wi-10651
 150 mm



Chirurgische und Anatomische Pinzetten
 Tissue and Dressing Forceps
 Pinzette anatomiche e chirurgiche
 Pinzas de diseccion y chirùrgicas
 Pincas anatomiques chirurgicales

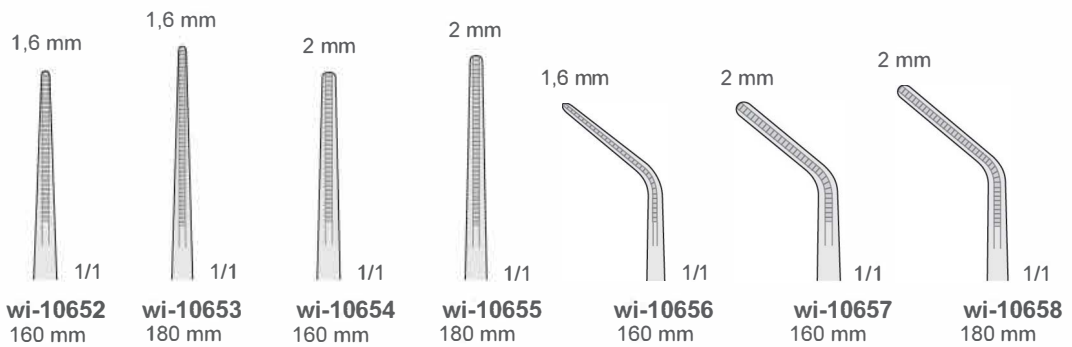

Atraumatische pinzetten
 Non-traumatic forceps
 Pinzette atraumatiche
 Pinzas atraumaticas
 Pincas atraumatiques

DE BAKEY
 wi-10659

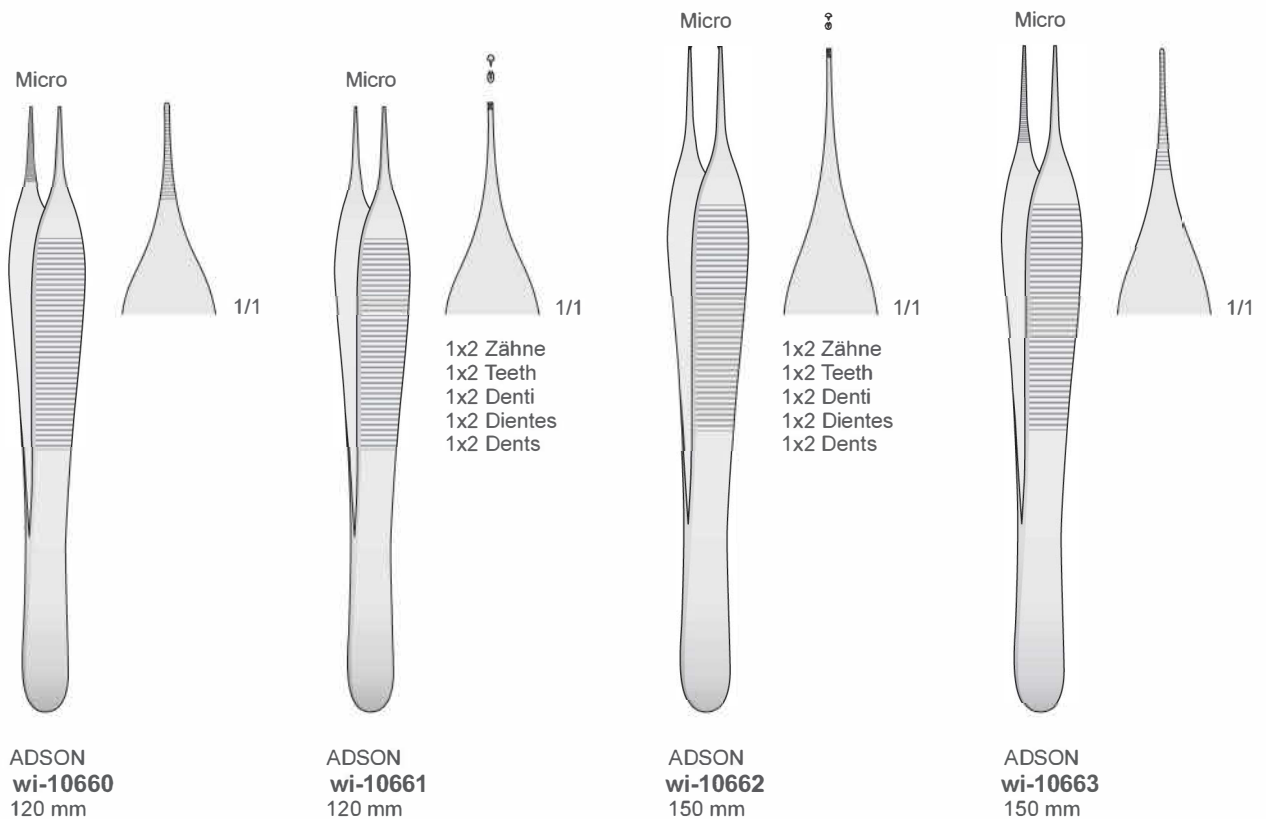



Chirurgische Pinzetten
Tissue Forceps
Pinzette chirurgiche
Pinzas quirùrgicas
Pincas quirurgicales

Taschenmarkierungspinzetten
Pocket markers
Pinzette segnatasche
Pinzas para marcar el sulco periodontal
Pincas à marquer la poche

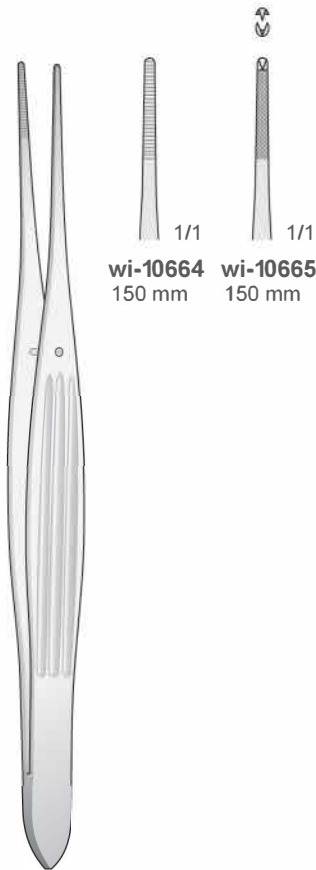

wi-10664
150 mm

wi-10665
150 mm

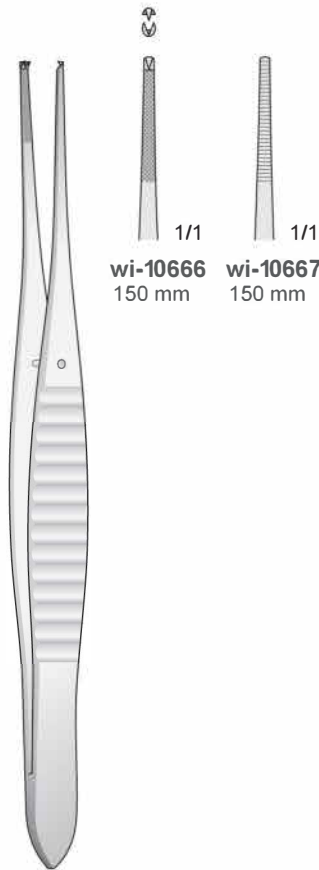

wi-10666
150 mm

wi-10667
150 mm

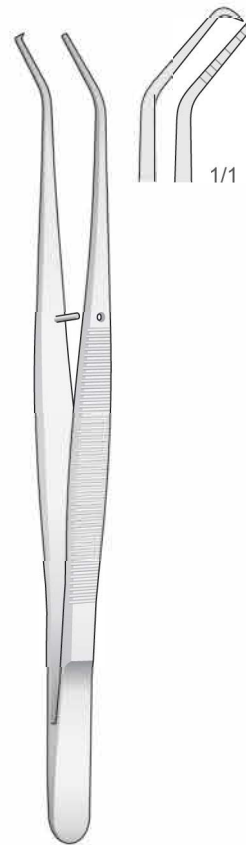

CRANE-CAPLAN
wi-10670
150 mm



CRANE-CAPLAN
wi-10671
150 mm



Chirurgische Pinzetten
Tissue Forceps
Pinzette chirurgiche
Pinzas quirúrgicas
Pincas quirurgicales

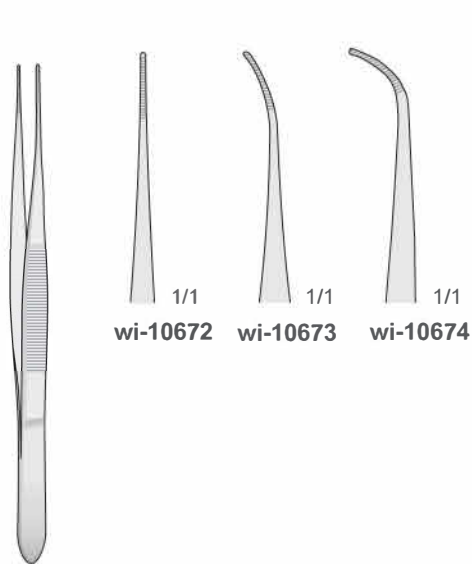

1/1
wi-10672 wi-10673 wi-10674

GRAEFE
wi-1067B
100 mm

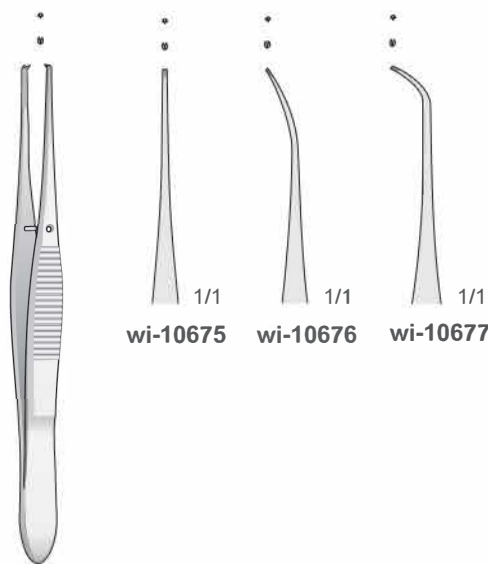

1/1
wi-10675 wi-10676 wi-10677

GRAEFE
wi-10679
100 mm

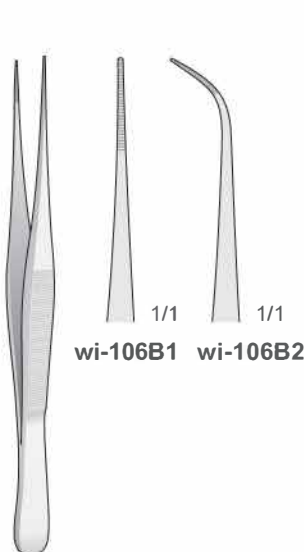

1/1
wi-106B1 wi-106B2

wi-106B0
100 mm

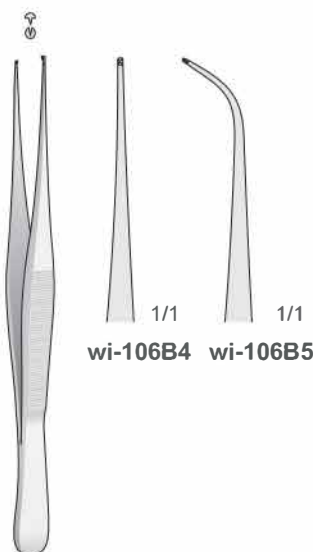

1/1
wi-106B4 wi-106B5

wi-106B3
100 mm

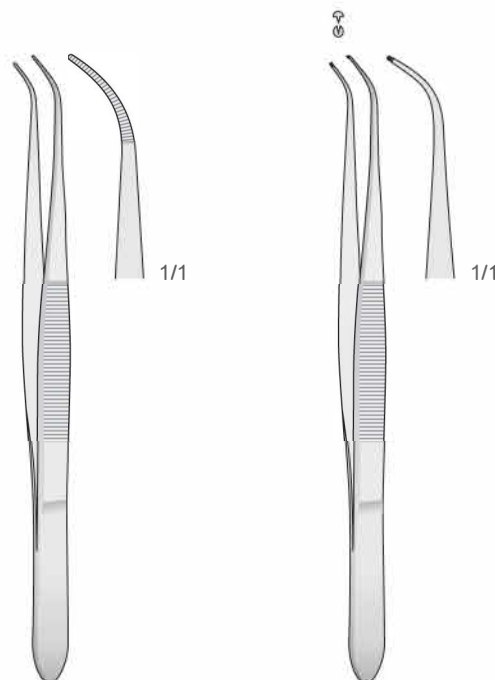

PERRY
wi-106B6
125 mm

wi-106B7
125 mm



Anatomische Pinzetten
 Dressing Forceps
 Pinzette anatomiche
 Pinzas de diseccion
 Pincas anatomiques

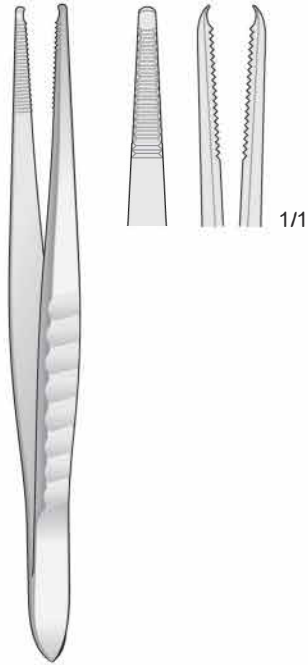

wi-10688
130 mm

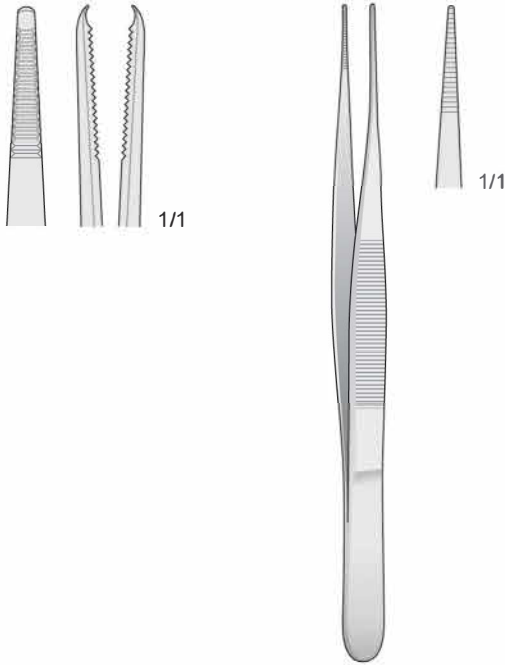

wi-10689
130 mm

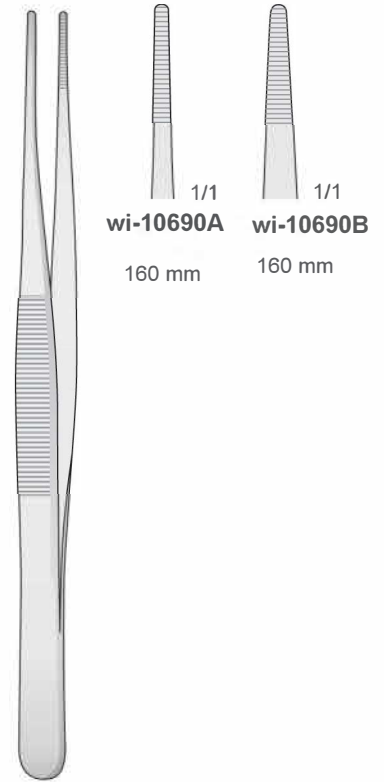

wi-10690
160 mm



wi-10697

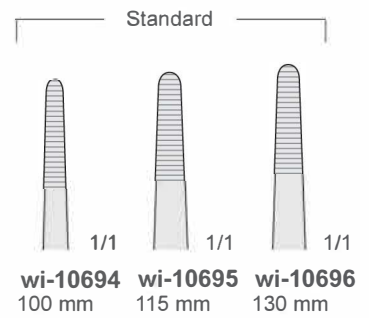
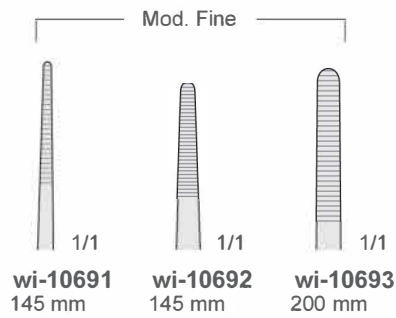

wi-10698



Chirurgische Pinzetten
Tissue Forceps
Pinzette chirurgiche
Pinzas quirúrgicas
Pincas quirurgicas

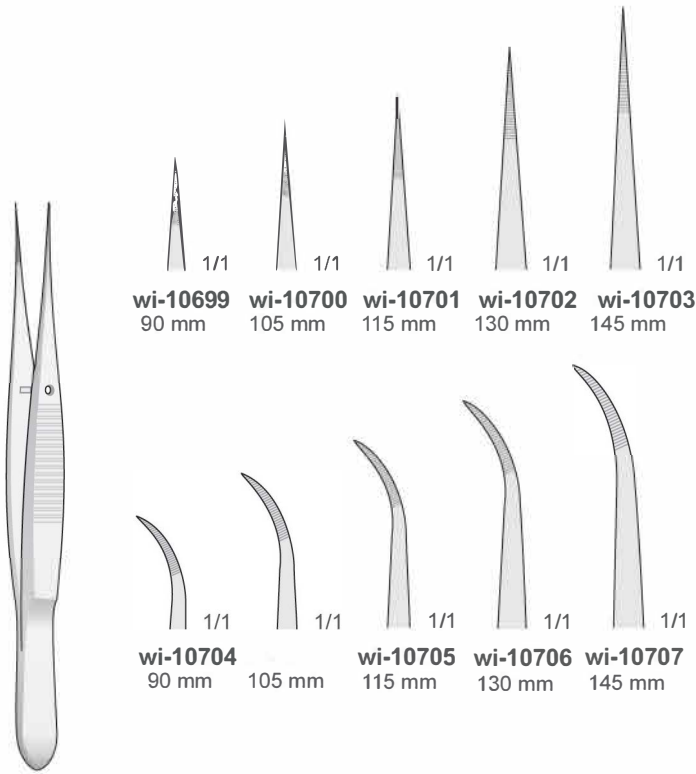

wi-10699 90 mm
wi-10700 105 mm
wi-10701 115 mm
wi-10702 130 mm
wi-10703 145 mm

wi-10704 90 mm
wi-10705 105 mm
wi-10706 130 mm
wi-10707 145 mm

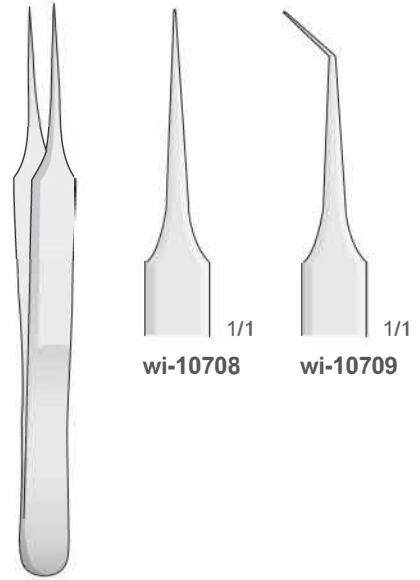

wi-10708 1/1
wi-10709 1/1

wi-10710

wi-10711
110 mm

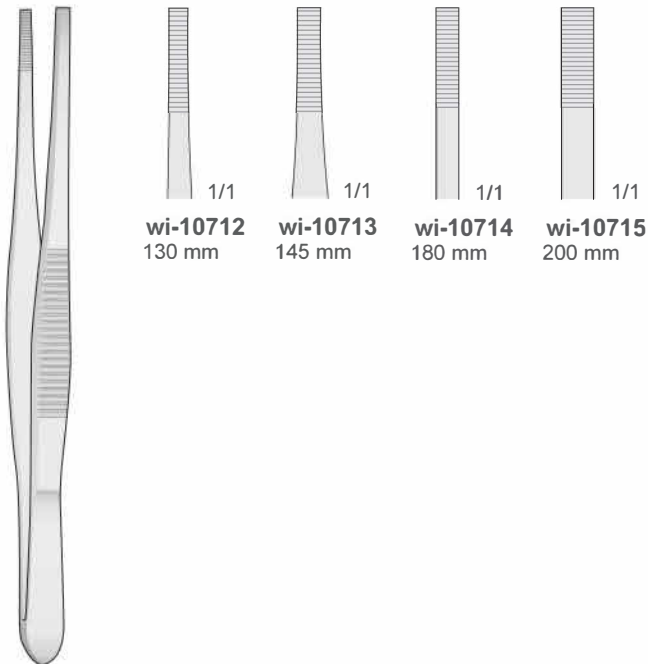

wi-10712 130 mm
wi-10713 145 mm
wi-10714 180 mm
wi-10715 200 mm

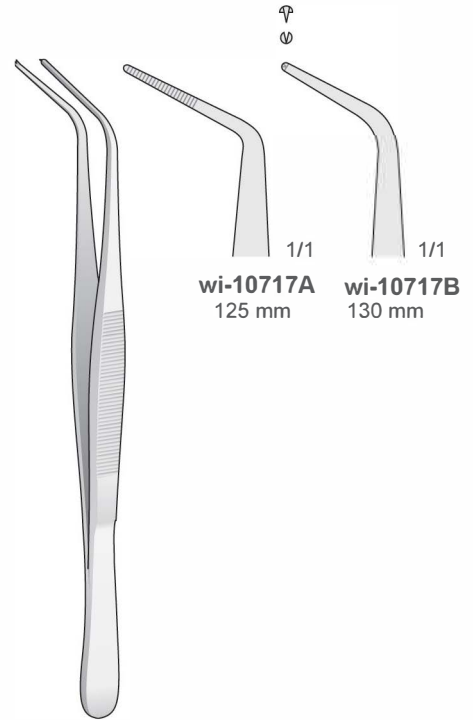

wi-10717A 125 mm
wi-10717B 130 mm

STILLE
wi-10716

wi-10717



Chirurgische Pinzetten
Tissue Forceps
Pinzette chirurgiche
Pinzas quirùrgicas
Pincas quirurgicales

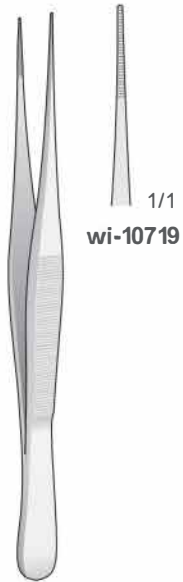

wi-1071B
110 mm

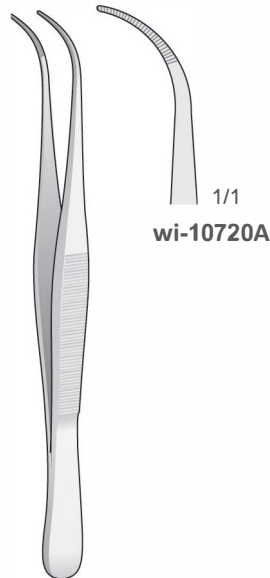

wi-10720
110 mm



wi-10721
110 mm

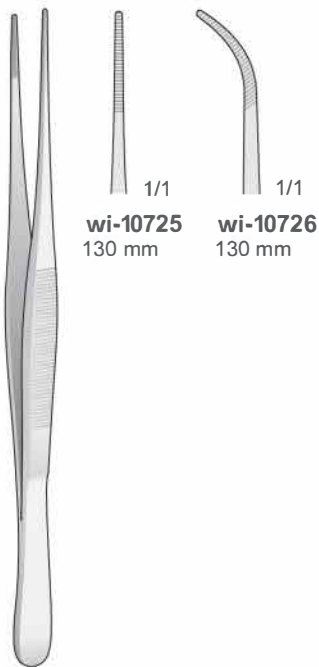

SEMKEN
wi-10724
130 mm

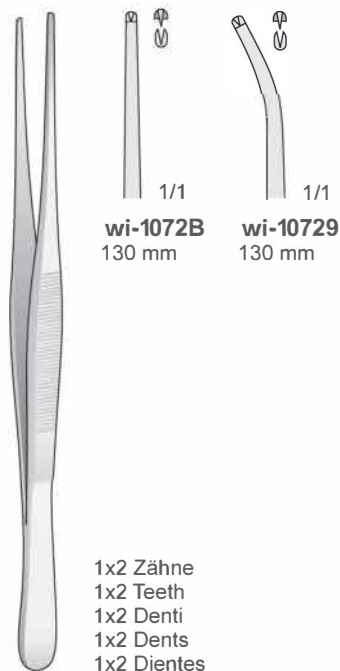

SEMKEN
wi-10727
130 mm

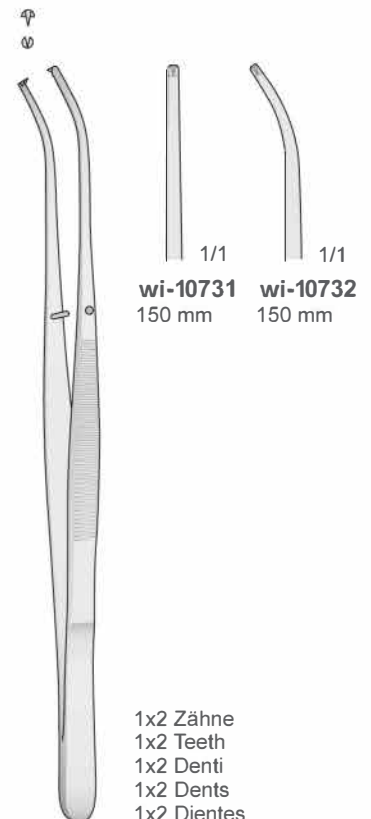

SEMKEN
wi-10730
150 mm



Chirurgische Pinzetten
Tissue Forceps
Pinzette chirurgiche
Pinzas quirúrgicas
Pincas quirúrgicas

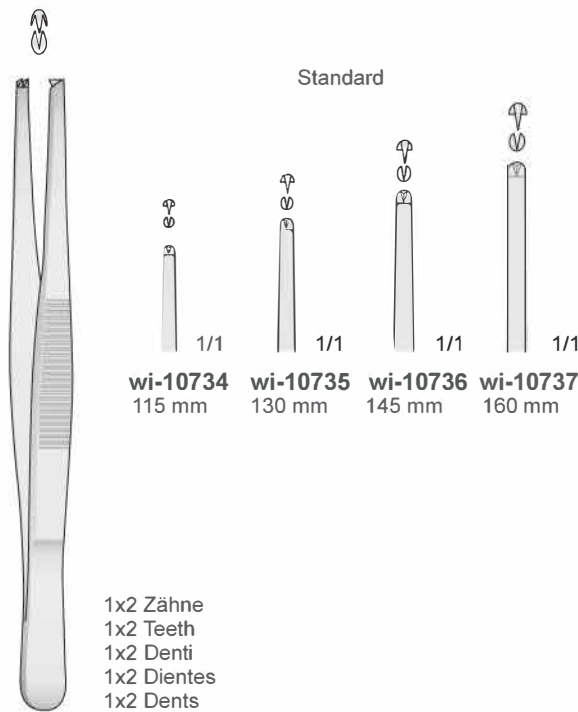

wi-10733

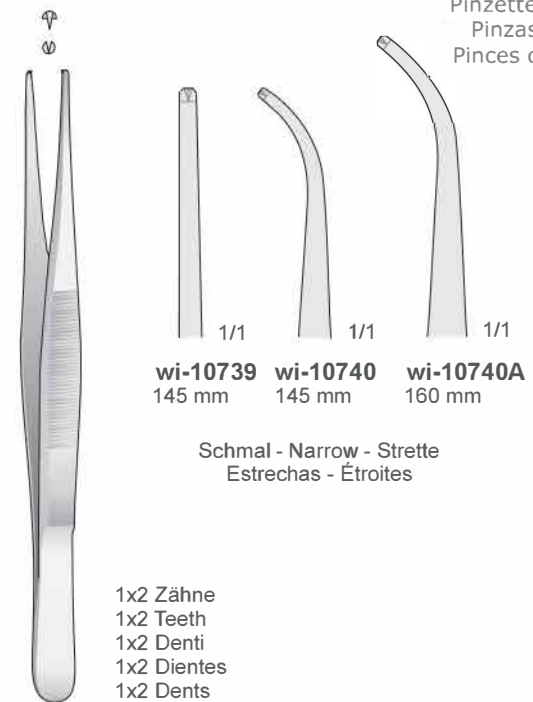

wi-10738

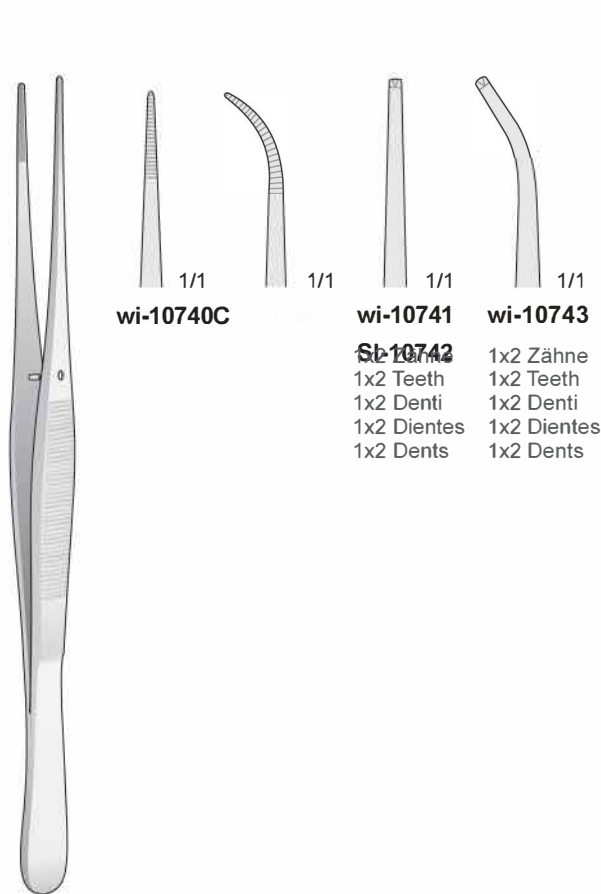

wi-10740B
200 mm

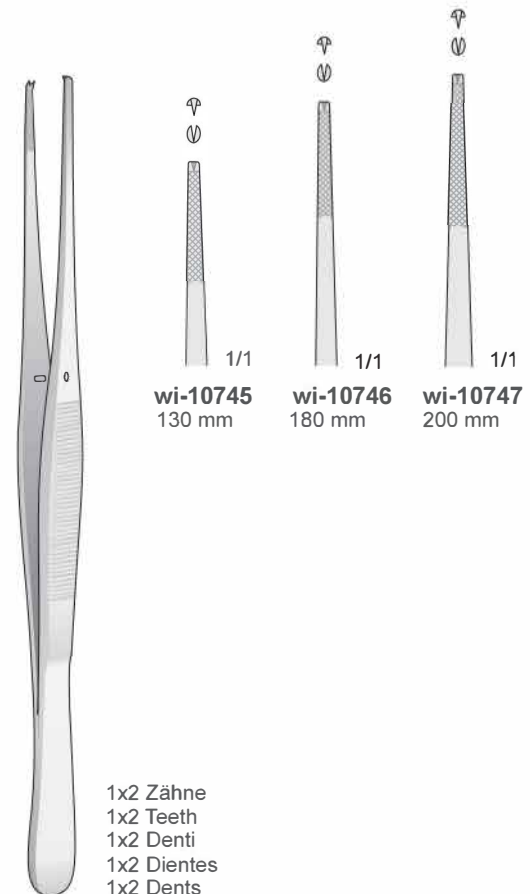

wi-10744



Chirurgische Pinzetten
Tissue Forceps
Pinzette chirurgiche
Pinzas quirùrgicas
Pincas quirurgicales

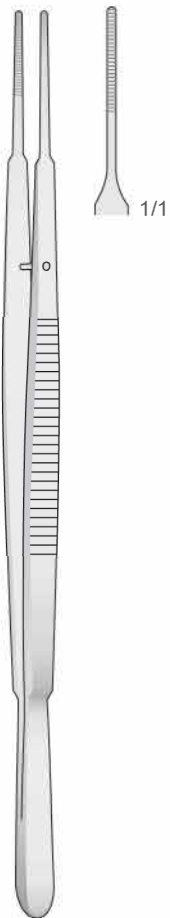

GERALD
wi-10749
180 mm

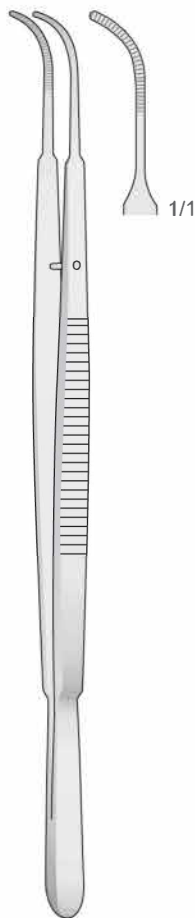

GERALD
wi-10750
180 mm

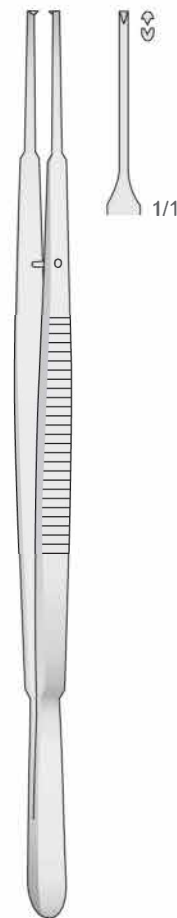

GERALD
wi-10751
180 mm

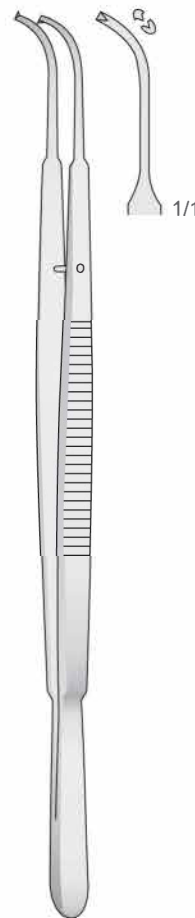

GERALD
wi-10752
180 mm

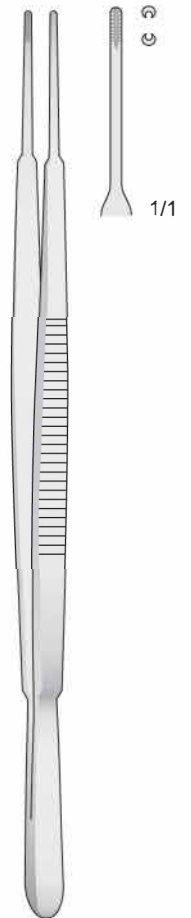

GERALD-BROWN
wi-10753
180 mm



Membrane Forceps
with delicate Ring tip

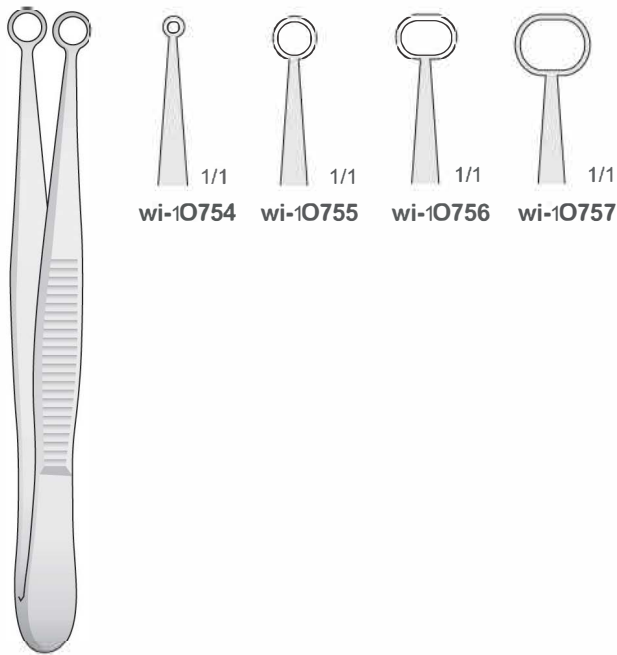

wi-10754 1/1 wi-10755 1/1 wi-10756 1/1 wi-10757 1/1

Chirurgische Pinzetten
Tissue Forceps
Pinzette chirurgiche
Pinzas chirùrgicas
Pincas chirurgicales

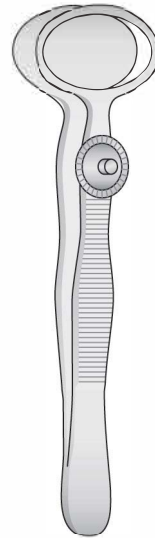

DESARMES
wi-10761
90 mm

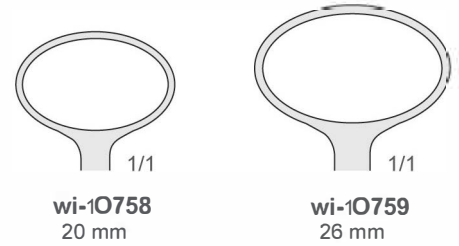

wi-10758
20 mm

wi-10759
26 mm

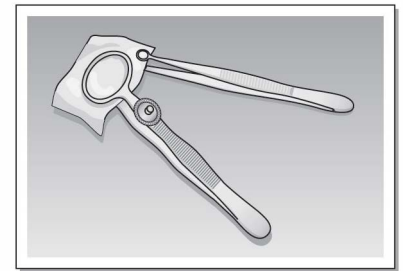

wi-10760
100 mm

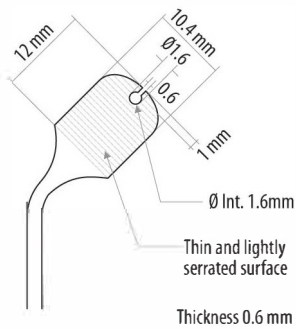

wi-10762
150 mm

Pinzetten zum Halten Membranen
Membrane Holding forceps
Pinza per fissaggio membrane
Pinza para sostener membranas
Pince pour le maintien membranes

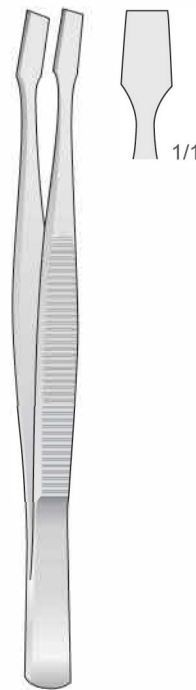

KÜHNE
wi-10763
105 mm

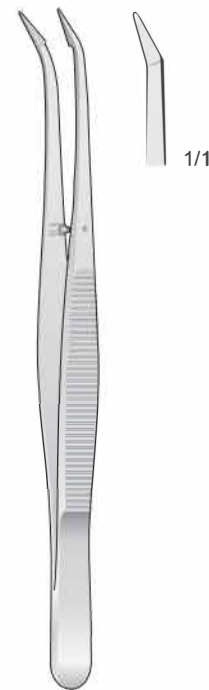

BARRAQUER
wi-10764
105 mm



Chirurgische Pinzetten
Tissue Forceps
Pinzette chirurgiche
Pinzas quirúrgicas
Pincas quirúrgicas

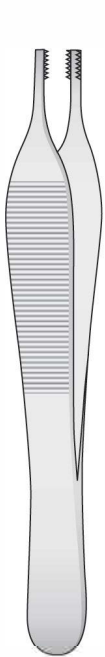

ADSON-BROWN
wi-10769
120 mm

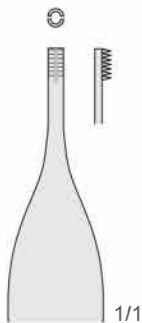

wi-10765
120 mm

6x6 Zähne
6x6 Teeth
6x6 Denti
6x6 Dientes
6x6 Dents

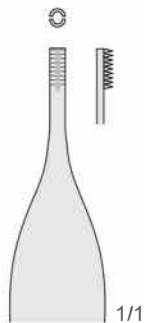

wi-10766
120 mm

9x9 Zähne
9x9 Teeth
9x9 Denti
9x9 Dientes
9x9 Dents

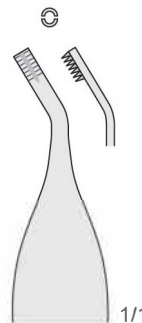

wi-10767
120 mm

6x6 Zähne
6x6 Teeth
6x6 Denti
6x6 Dientes
6x6 Dents



ADSON
wi-10770
120 mm

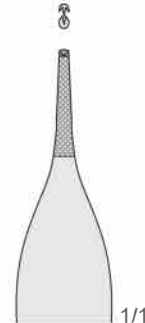

wi-10768
120 mm



BROWN
wi-10771
150 mm

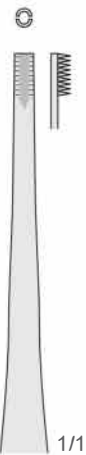

8x8 Zähne
8x8 Teeth
8x8 Denti
8x8 Dientes
8x8 Dents



ADSON
wi-10772
150 mm

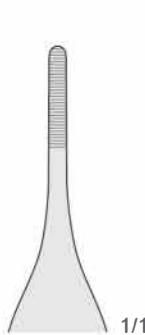

ADSON
wi-10773
150 mm



1x2 Zähne
1x2 Teeth
1x2 Denti
1x2 Dientes
1x2 Dents



ADSON-BROWN
wi-10774
150 mm

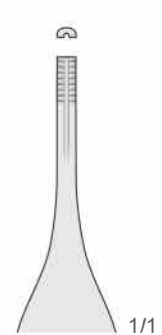

9x9 Zähne
9x9 Teeth
9x9 Denti
9x9 Dientes
9x9 Dents



Chirurgische Pinzetten
Tissue Forceps
Pinzette chirurgiche
Pinzas quirúrgicas
Pincas chirurgicales

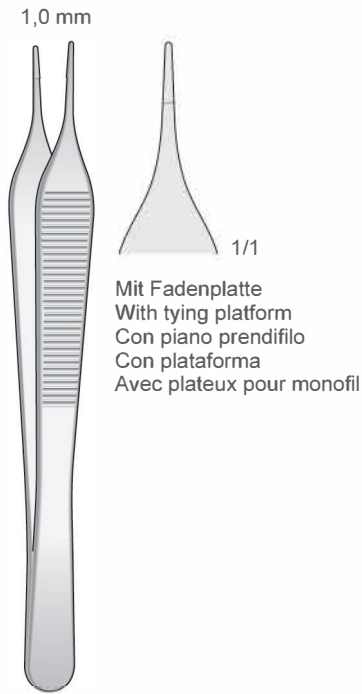

ADSON
wi-10775
120 mm

Mit Fadenplatte
With tying platform
Con piano prendifilo
Con plataforma
Avec plateaux pour monofil

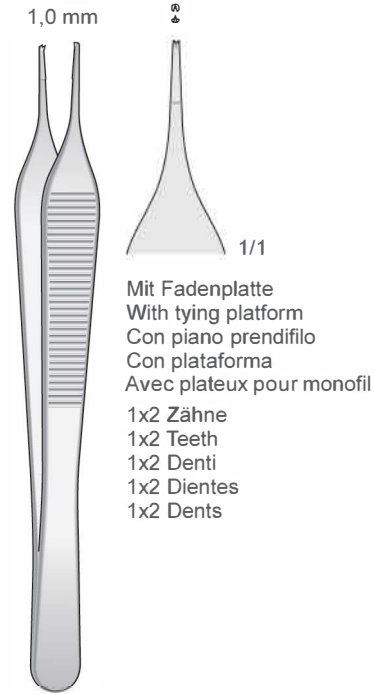

ADSON
wi-10776
120 mm

Mit Fadenplatte
With tying platform
Con piano prendifilo
Con plataforma
Avec plateaux pour monofil
1x2 Zähne
1x2 Teeth
1x2 Denti
1x2 Dientes
1x2 Dents

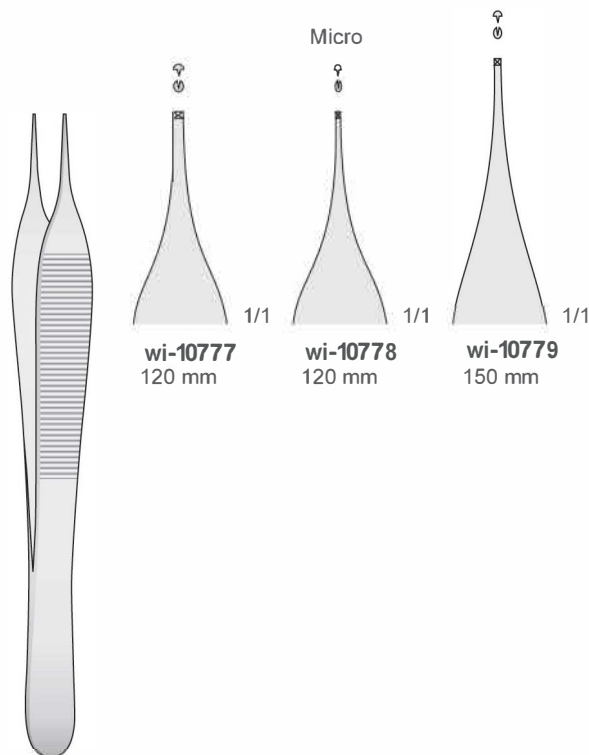

ADSON
wi-10783

wi-10777
120 mm

wi-10778
120 mm

wi-10779
150 mm

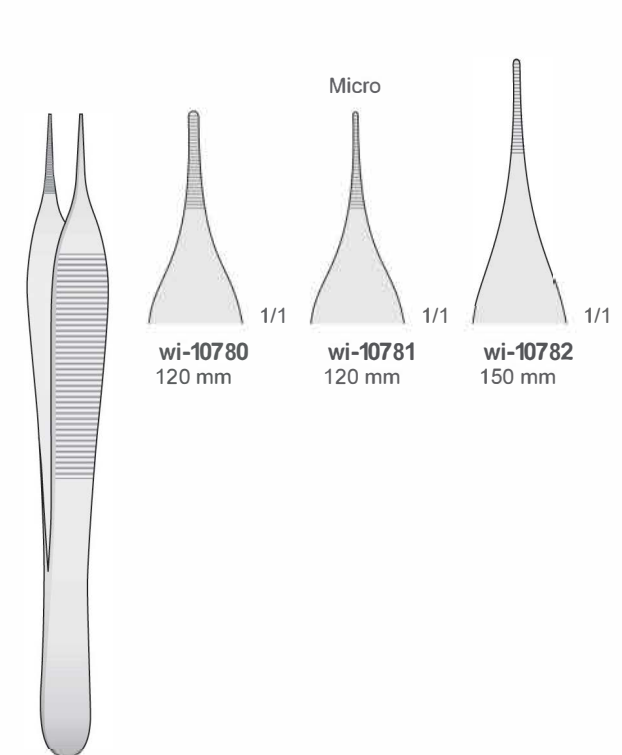

ADSON
wi-10784

wi-10780
120 mm

wi-10781
120 mm

wi-10782
150 mm



Chirurgische Pinzetten - Anatomische Pinzetten

Tissue Forceps - Dressing forceps
 Pinzette chirurgiche - Pinzette anatomiche
 Pinzas quirúrgicas - Pinzas de disección
 Pincas chirurgicales - Pincas anatomiques



wi-10791

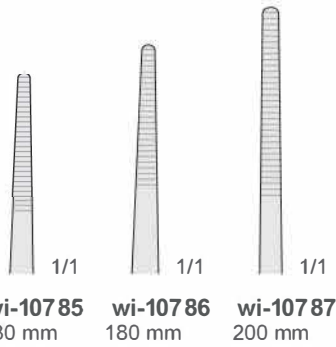

wi-10785 130 mm
wi-10786 180 mm
wi-10787 200 mm



wi-10792

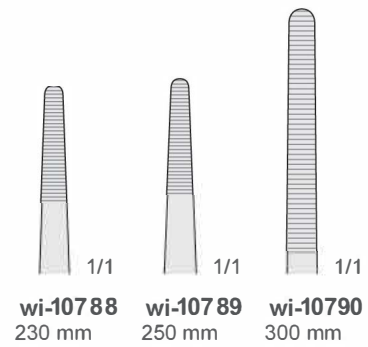

wi-10788 230 mm
wi-10789 250 mm
wi-10790 300 mm



wi-10798

1x2 Zähne
 1x2 Teeth
 1x2 Denti
 1x2 Dientes
 1x2 Dents

Schmal - Narrow Strette - Estrechas Étroites

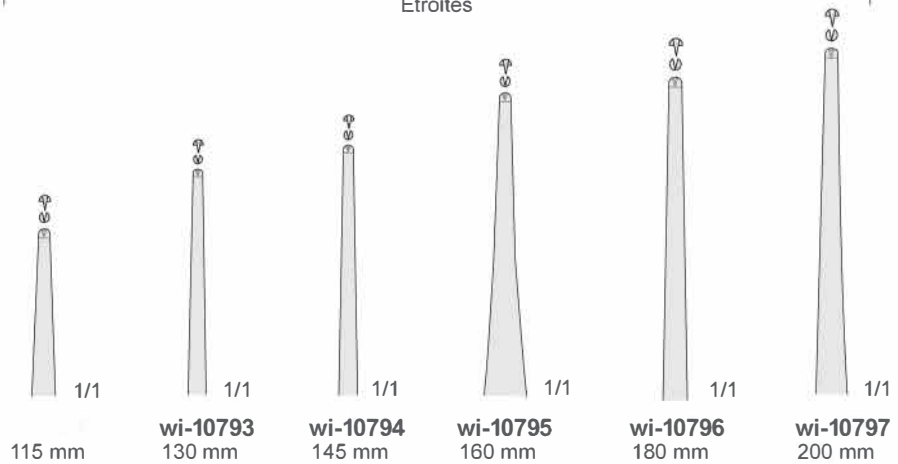

115 mm
wi-10793 130 mm
wi-10794 145 mm
wi-10795 160 mm
wi-10796 180 mm
wi-10797 200 mm



Chirurgische Pinzetten
Tissue Forceps
Pinzette chirurgiche
Pinzas quirúrgicas
Pincas quirurgicales

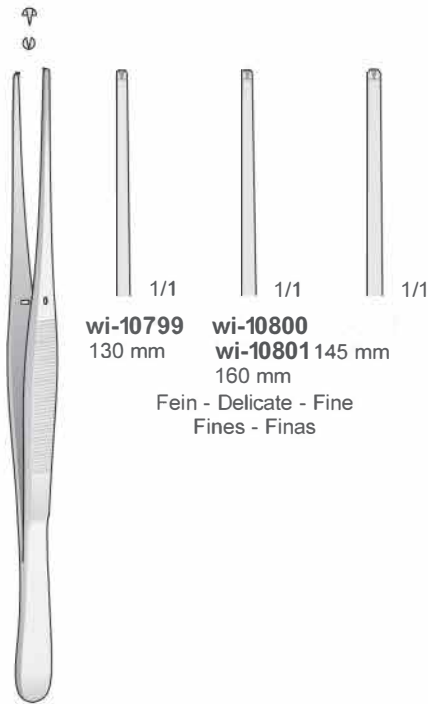

wi-10799
130 mm
wi-10800
wi-10801 145 mm
160 mm
Fein - Delicate - Fine
Fines - Finas

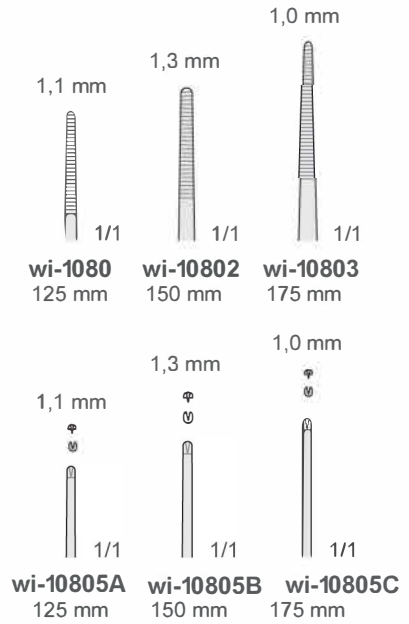

wi-10804

wi-10805

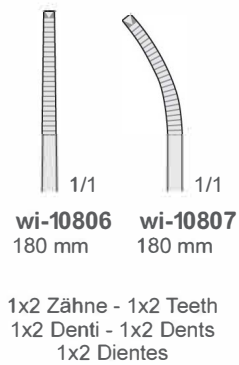

POTTS-SMITH
wi-10811
180 mm

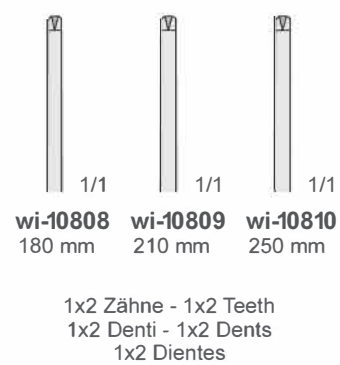

POTTS-SMITH
wi-10812



Nadelhalter
Needle Holders
Port'aghi
Portaagujas
Porte aiguilles

Mit Scheren
With Scissor
Con forbice
Con tijeras
Avec ciseaux

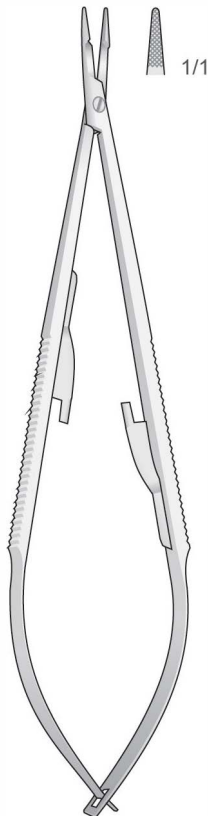

wi-10817
140 mm

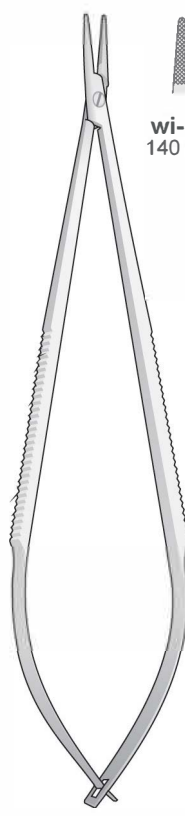

wi-10818
140 mm



wi-10813 140 mm
wi-10814 140 mm

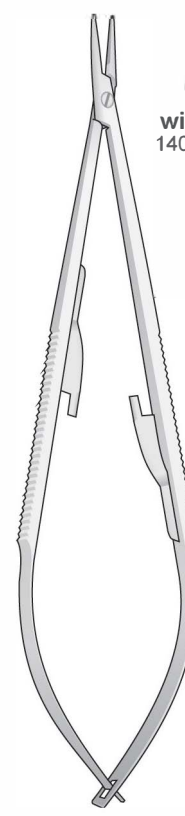

CASTROVIEJO
wi-10819
140 mm



wi-10815 140 mm
wi-10816 140 mm

Glattes Maul
Smooth Jaw
Morso liscio
Mandibula lisa
Mors lisse



Nadelhalter
Needle Holders
Port'aghi
Portaagujas
Porte aiguilles

Mit Locking-System
With Locking System (stop)
Con sistema di bloccaggio
Con sistema de bloqueo
Avec système de verrouillage

Glattes Maul
Smooth Jaw
Morso liscio
Mandíbula lisa
Mors lisse

Feingerieftes Maul
Fine serrated jaws
Morso zigrinato fine
Mandíbula estriada fina
Mors strié fin

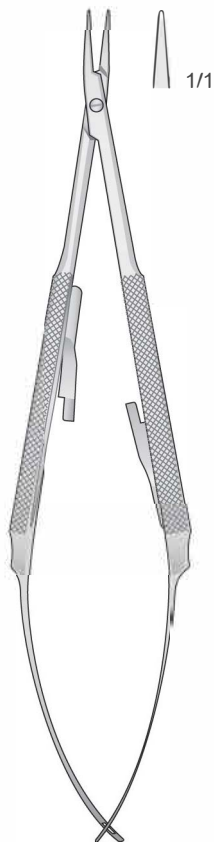

BARRAQUER
wi-10820
150 mm

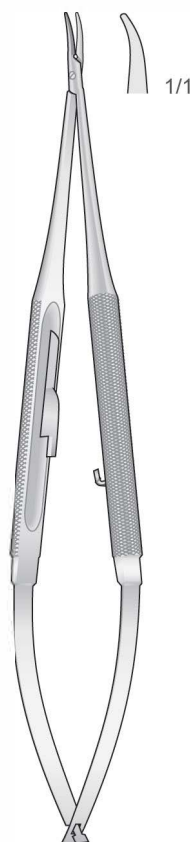

BARRAQUER
wi-10821
150 mm



BARRAQUER
wi-10824
150 mm

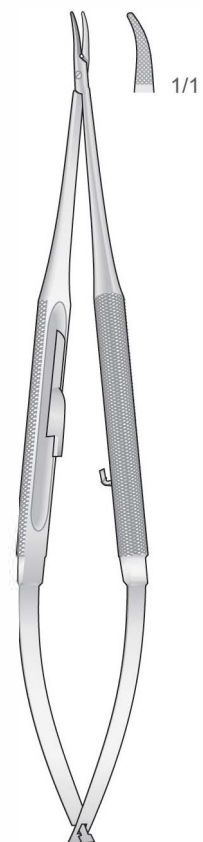

BARRAQUER
wi-10823
150 mm



Nadelhalter
Needle Holders
Port'aghi
Portaagujas
Porte aiguilles



Tungsten-Carbide Inserts
Mit Hartmetalleinsätzen
Plaquettes en carbure de tungstène
Plaquetas de carburo de tungsteno
Inserti in carburo di tungsteno

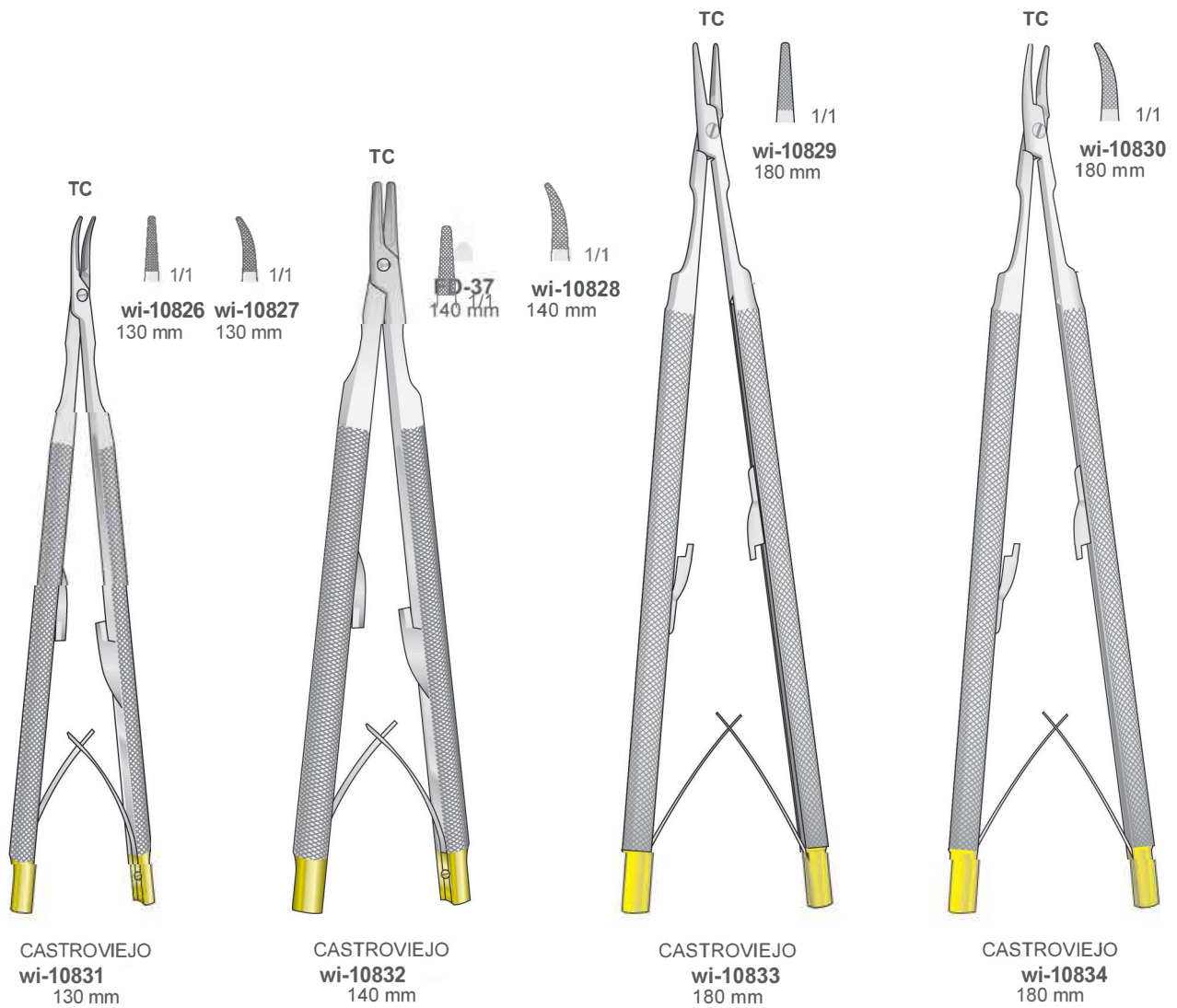



Nadelhalter
Needle Holders
Port'aghi
Portaagujas
Porte aiguilles



Tungsten-Carbide Inserts
Mit Hartmetalleinsätzen
Plaquettes en carbure de tungstène
Plaquetas de carburo de tungsteno
Inserti in carburo di tungsteno

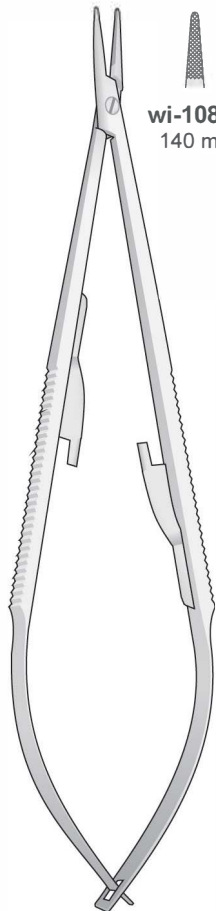

CASTROVIEJO
wi-10838
140 mm



1/1

wi-10838A
140 mm



1/1

wi-10835
140 mm

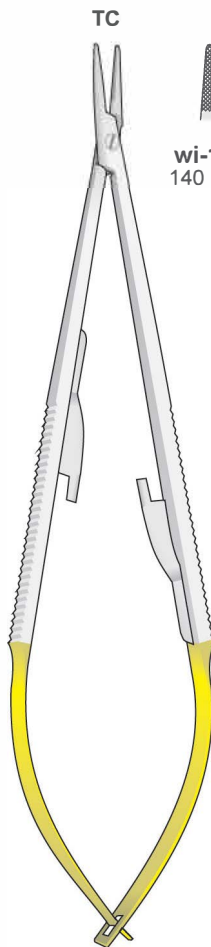

CASTROVIEJO
wi-10839
140 mm



1/1

wi-10836
140 mm



1/1

wi-10837
140 mm



CASTROVIEJO Mod.
wi-108040 140 mm



1/1



Nadelhalter
Needle Holders
Port'aghi
Portaagujas
Porte aiguilles



Tungsten-Carbide Inserts
Mit Hartmetalleinsätzen
Plaquettes en carbure de tungstène
Plaquetas de carburo de tungsteno
Inserti in carburo di tungsteno

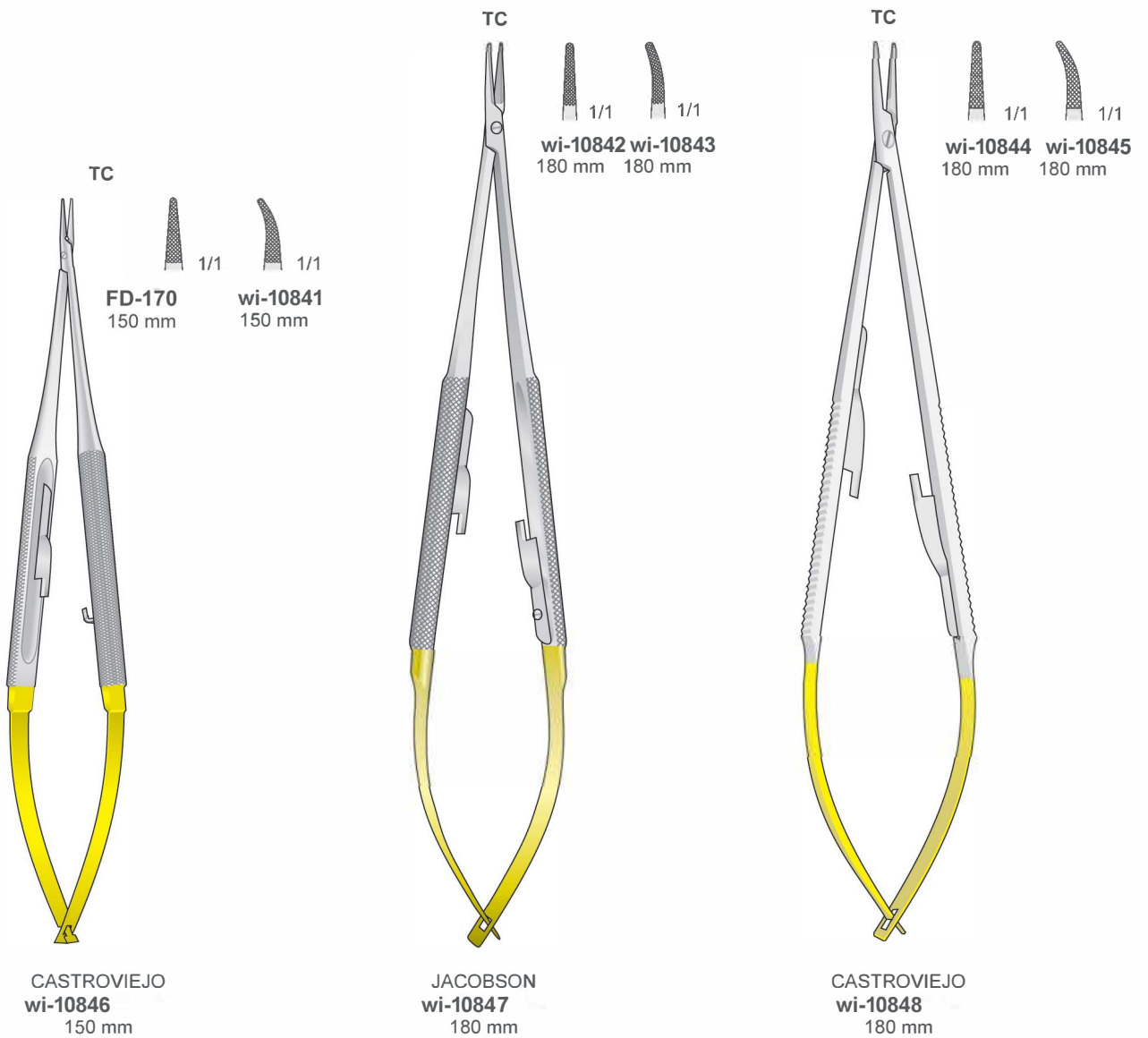



Nadelhalter
Needle Holders
Port'aghi
Portaagujas
Porte aiguilles

TC
TUNGSTEN
CARBIDE

Tungsten-Carbide Inserts
Mit Hartmetalleinsätzen
Plaquettes en carbure de tungstène
Plaquetas de carburo de tungsteno
Inserti in carburo di tungsteno

DIAMOND TIP

Diamond Tip
Diamantiert
Punta diamantata
Punta de diamante
Pointe de diamant

TC

Glattes Maul
Smooth jaws
Con morso liscio
Mandibula lisa
A' mors lisse

1/1 1/1

wi-10849 **wi1**
0850 140 mm 140 mm

CASTROVIEJO
wi-10853
140 mm

1/1 1/1

wi40 81

wi-10854
150 mm

1/1 1/1

wi-10852

wi-10855
180 mm



Mikro Nadelhalter - Mikro Scheren
 Micro Needle Holders - Micro Scissors
 Micro Port'aghi - Micro Forbici
 Micro Portaagujas - Micro Tijeras
 Micro Porte aiguilles - Micro Ciseaux



Titanium
 Titan
 Titane
 Titanio
 Titanio

Rund-Griffe Ø 8 mm
 Round handle Ø 8 mm
 Manico rotondo Ø 8 mm
 Mango redondo Ø 8 mm
 Manche rond Ø 8 mm

Mikro Nadelhalter
 Micro Needle Holders
 Micro port'aghi
 Micro portaagujas
 Micro porte aiguilles

Mikro Scheren
 Micro Scissors
 Micro forbici
 Micro tijeras
 Micro ciseaux



wi-10862
 180 mm

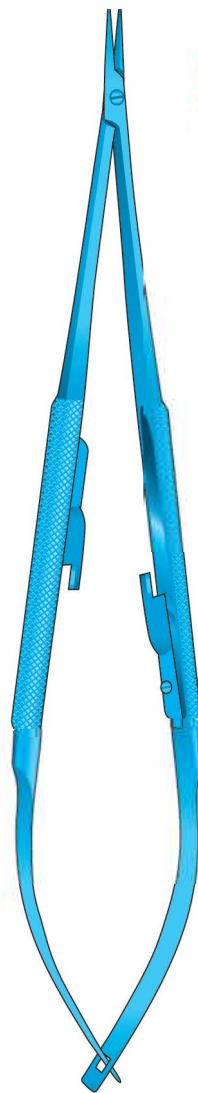

wi-10863
 180 mm



Mit Sperre
 With Lock
 Con arresto
 Con cierre
 Avec Arrêt



wi-10864
 180 mm

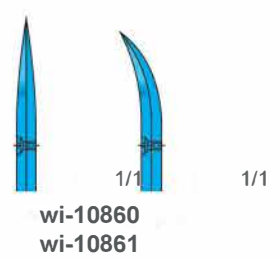



Nadelhalter
Needle Holders
Port'aghi
Portaagujas
Porte aiguilles

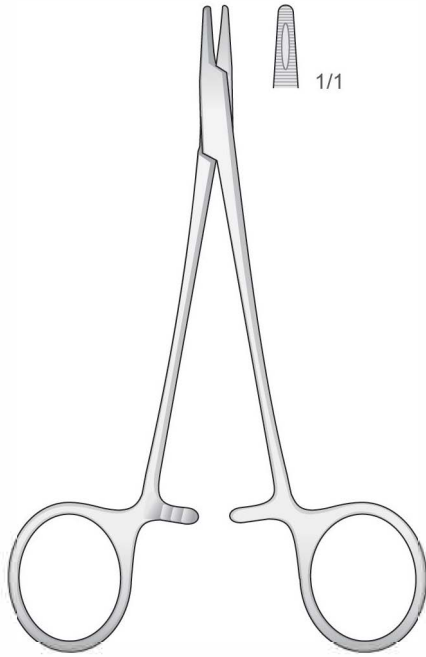

DERF
wi-10865
125 mm

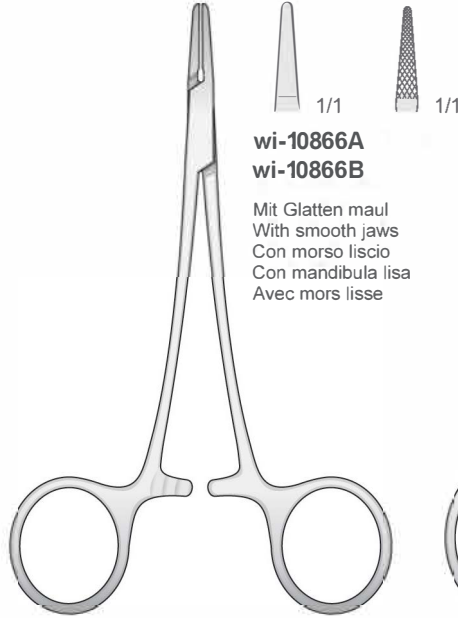

wi-10866A
wi-10866B

Mit Glatten maul
With smooth jaws
Con morso liscio
Con mandibula lisa
Avec mors lisse

wi-10866
120 mm

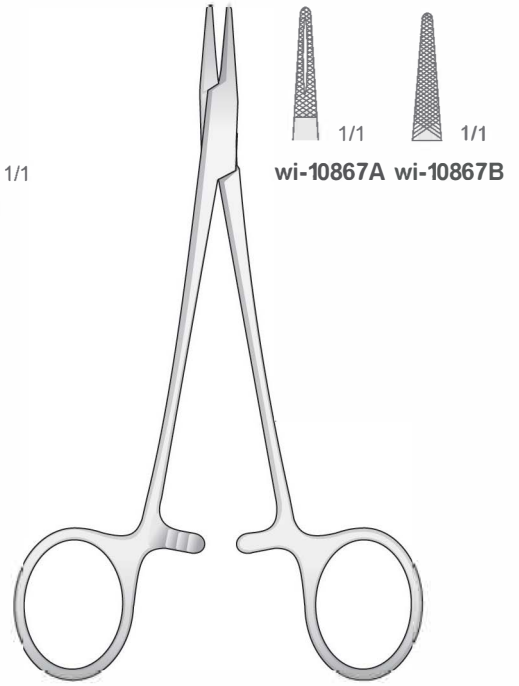

HALSEY
wi-10867
130 mm

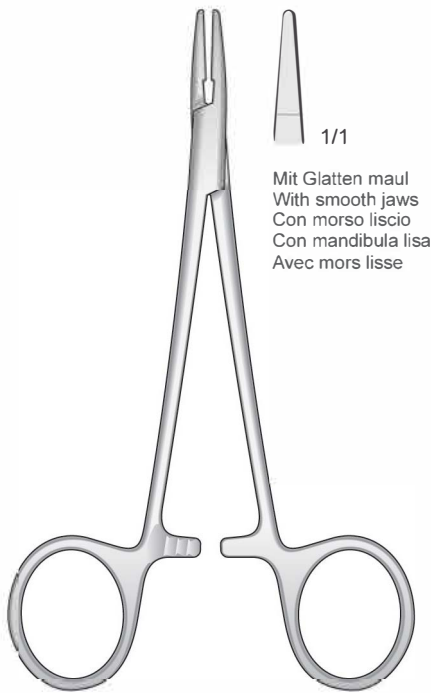

HALSEY
wi-10868
130 mm

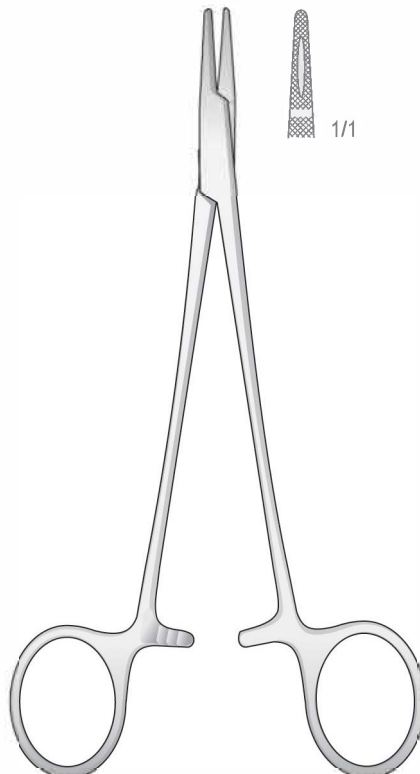

CRILE-WOOD
wi-10869
150 mm

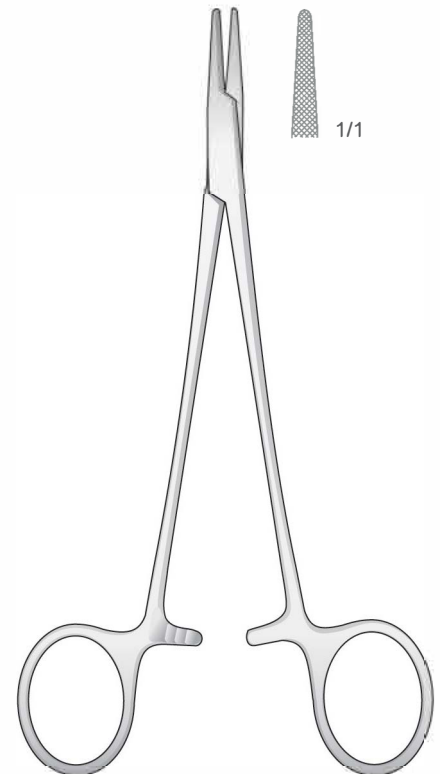

CRILE-MURRAY
wi-10870
150 mm



Nadelhalter mit Schere - Needle holders with scissors
Port'aghi con forbici - Portaagujas con tijeras
Porte aiguilles avec ciseaux

Nadelhalter
Needle Holders
Port'aghi
Portaagujas
Porte aiguilles

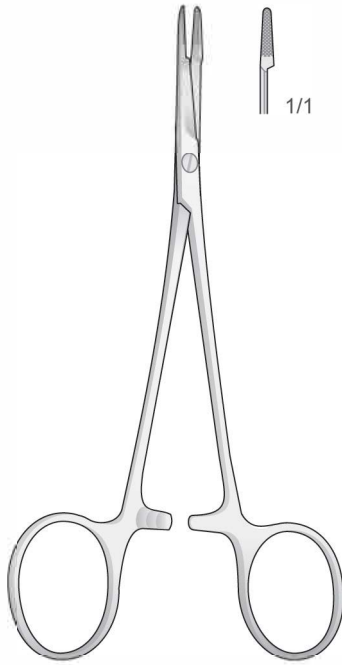

MINI-OLSEN-HEGAR
wi-10871
120 mm

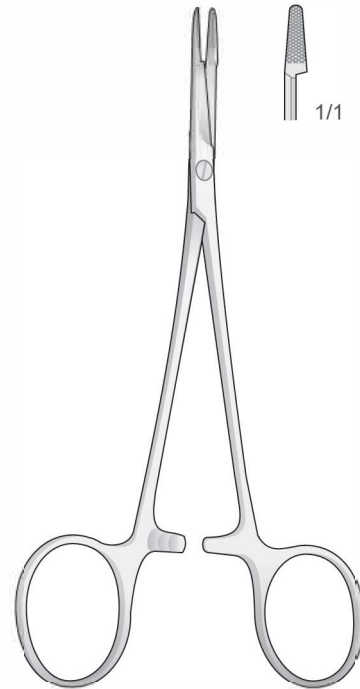

OLSEN-HEGAR
wi-10872
140 mm

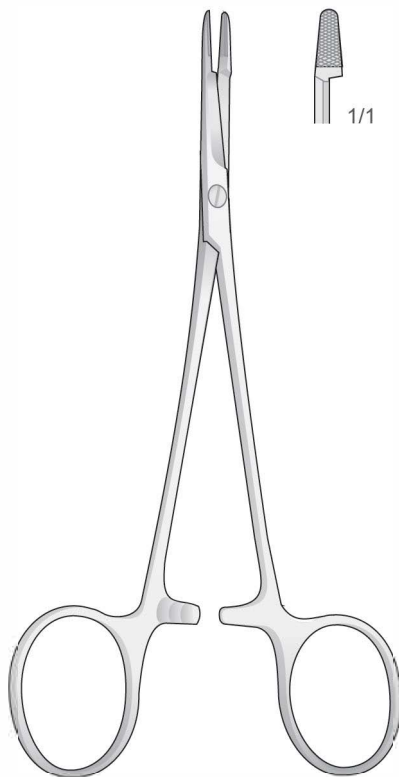

OLSEN-HEGAR
wi-10873
170 mm

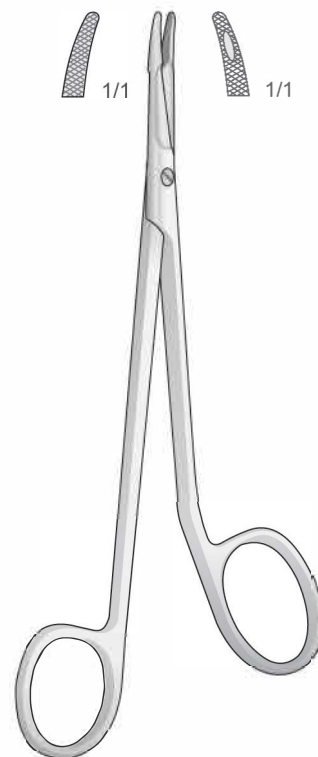

MINI-GILLIES
wi-10874
145 mm



Nadelhalter
Needle Holders
Port'aghi
Portaagujas
Porte aiguilles

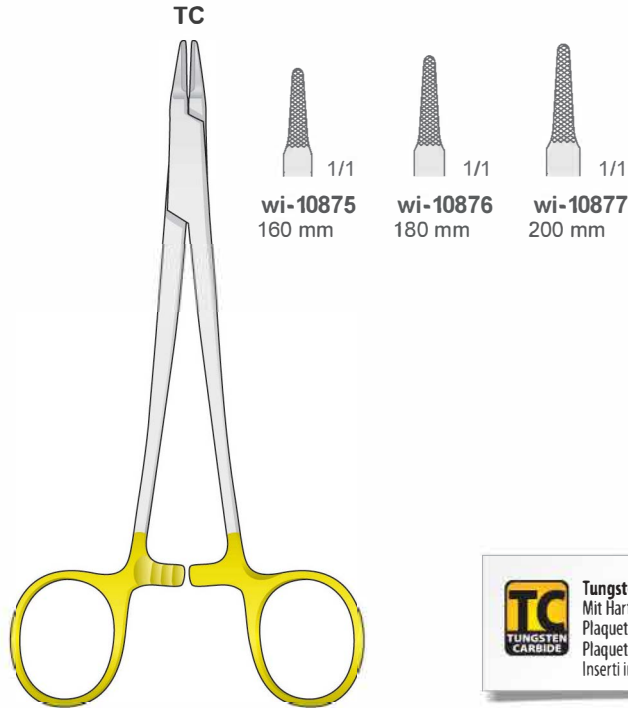

RYDER
wi-10878

TC
TUNGSTEN
CARBIDE

Tungsten-Carbide Inserts
Mit Hartmetalleinsätzen
Plaquettes en carbure de tungstène
Plaquetas de carburo de tungsteno
Inserti in carburo di tungsteno

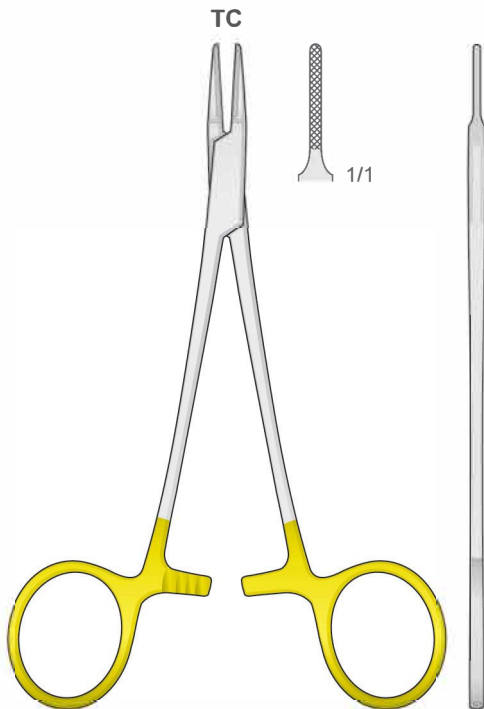

RYDER
wi-10879
140 mm

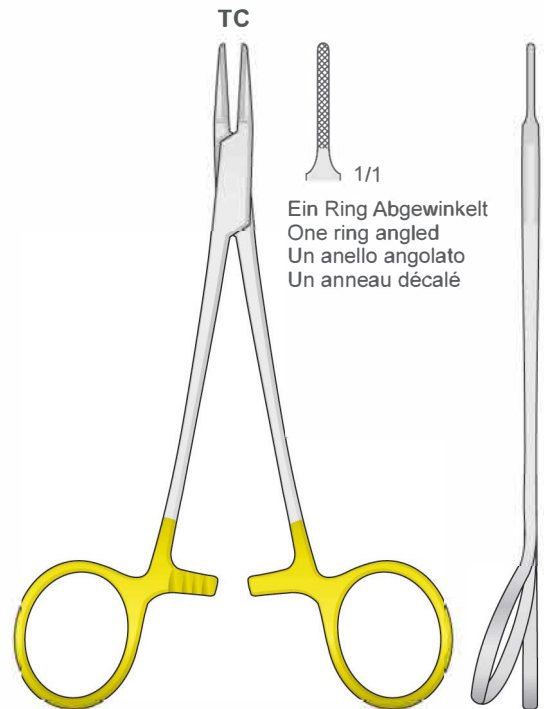

wi-10880
140 mm



Nadelhalter
Needle Holders
Port'aghi
Portaagujas
Porte aiguilles

TC
TUNGSTEN
CARBIDE

Tungsten-Carbide Inserts
Mit Hartmetalleinsätzen
Plaquettes en carbure de tungstène
Plaquetas de carburo de tungsteno
Inserti in carburo di tungsteno

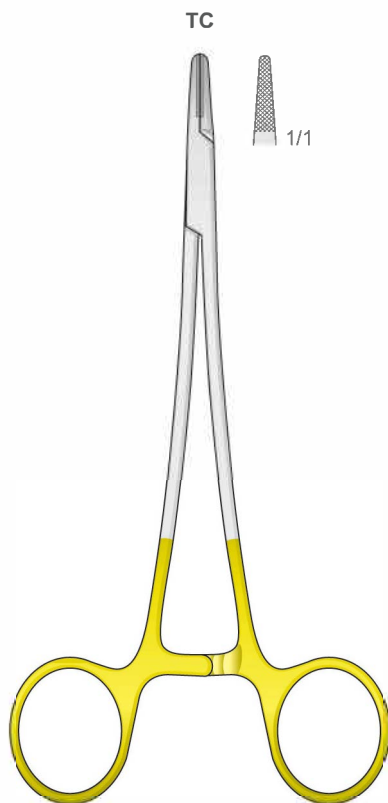

wi-10881
145 mm

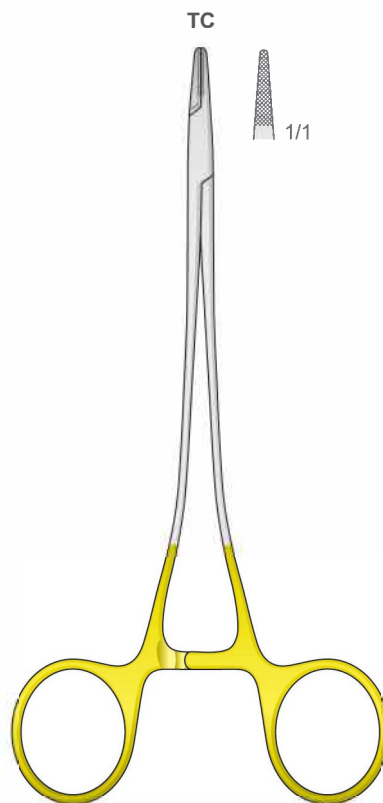

FINE SWEDISH PATTERN
wi-10882
150 mm

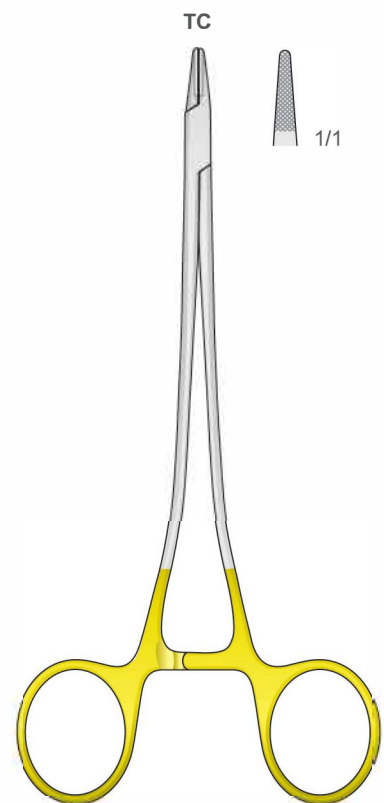

SWEDISH
MOD. **wi-10883**
150 mm



Nadelhalter
Needle Holders
Port'aghi
Portaagujas
Porte aiguilles

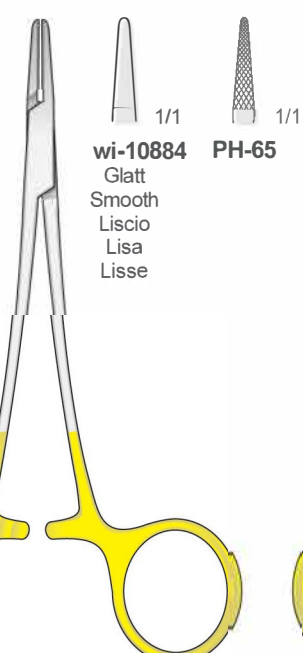
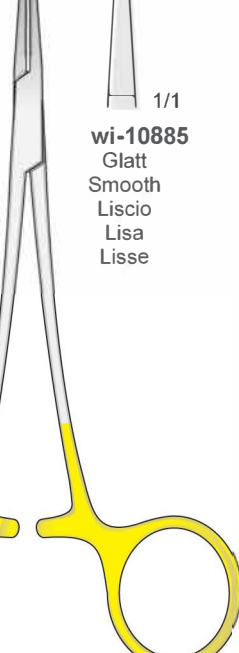
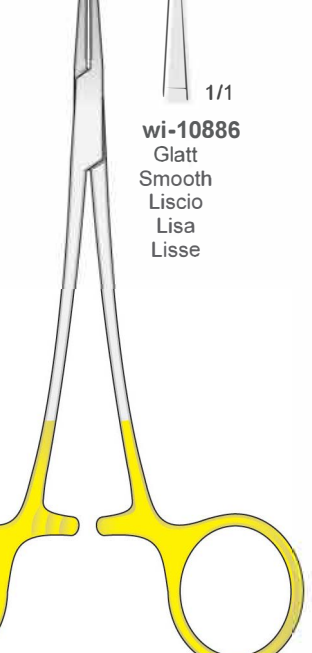
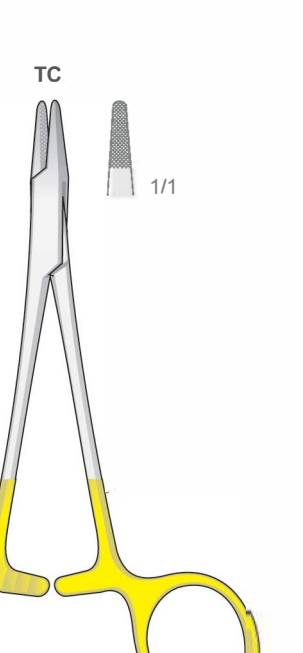
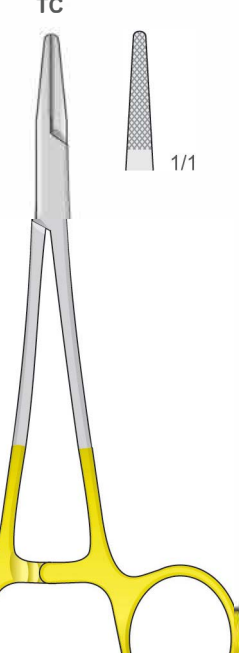
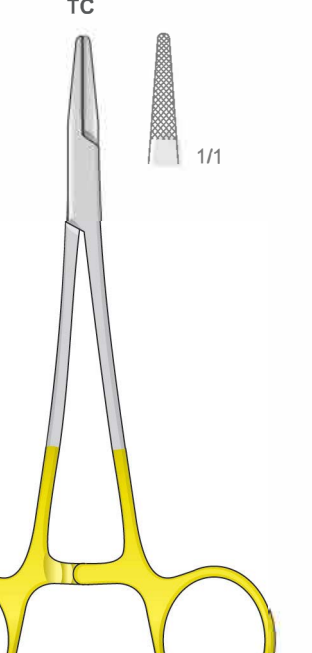

Tungsten-Carbide Inserts
Mit Hartmetalleinsätzen
Plaquettes en carbure de tungstène
Plaquetas de carburo de tungsteno
Inserti in carburo di tungsteno

<p>TC</p>  <p>wi-10884 Glatt Smooth Liscio Lisa Lisse</p> <p>PH-65</p> <p>wi-10887 120 mm</p>	<p>TC</p>  <p>wi-10885 Glatt Smooth Liscio Lisa Lisse</p> <p>WEBSTER wi-10888 130 mm</p>	<p>TC</p>  <p>wi-10886 Glatt Smooth Liscio Lisa Lisse</p> <p>HALSEY wi-10889 130 mm</p>
<p>TC</p>  <p>wi-10890 115 mm</p> <p>DERF</p>	<p>TC</p>  <p>wi-10891 130 mm</p> <p>CONVERSE</p>	<p>TC</p>  <p>wi-10892 130 mm</p> <p>HALSEY</p>



TC
TUNGSTEN
CARBIDE

Tungsten-Carbide Inserts
Mit Hartmetalleinsätzen
Plaquettes en carbure de tungstène
Plaquetas de carburo de tungsteno
Inserti in carburo di tungsteno

Nadelhalter
Needle Holders
Port'aghi
Portaagujas
Porte aiguilles

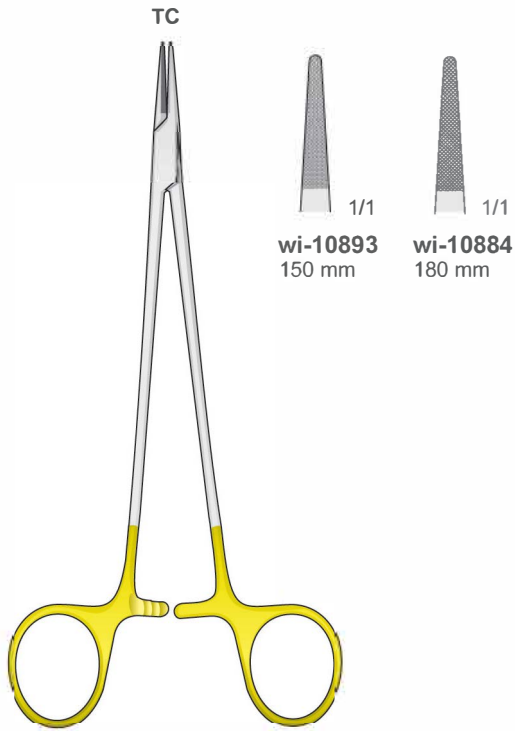

DE BAKEY
wi-10898

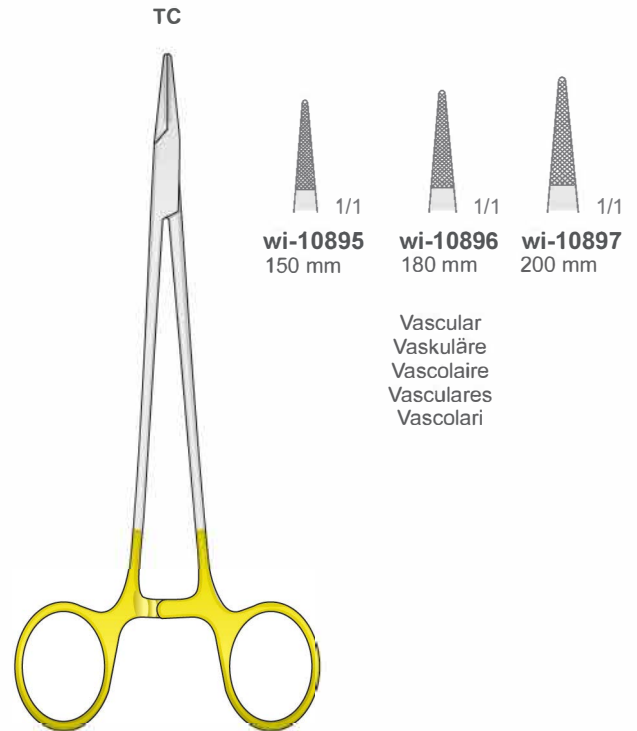

MICRO-
VASCULAR wi-10899

Vascular
Vaskuläre
Vasculaire
Vasculares
Vascolari

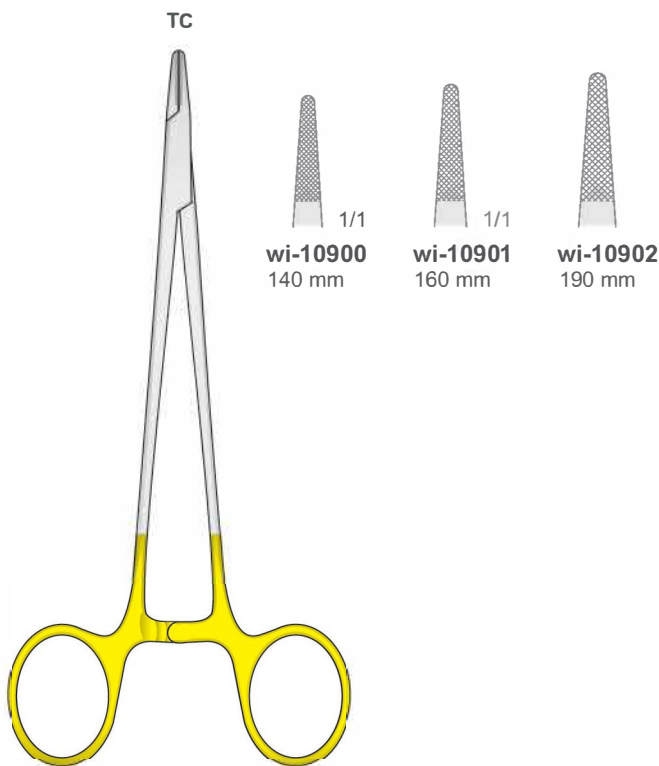

MAYO-HEGAR
wi-10906

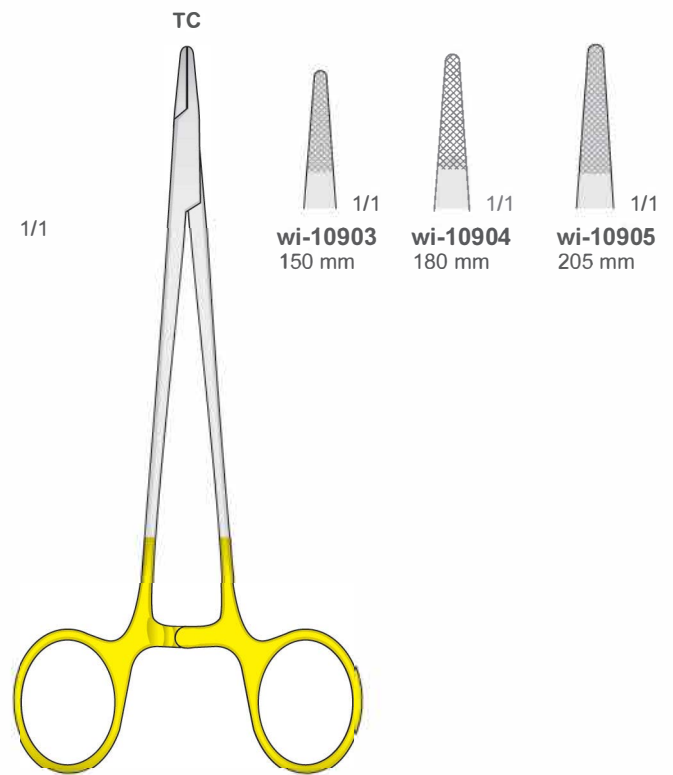

MAYO-HEGAR-FINO
wi-10907



Chirurgische Pinzetten - Anatomische Pinzetten

Tissue Forceps - Dressing forceps
 Pinzette chirurgiche - Pinzette anatomiche
 Pinzas quirùrgicas - Pinzas de diseccion
 Pincas quirurgicales - Pincas anatomiques

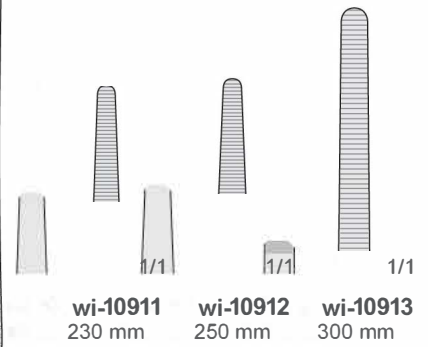
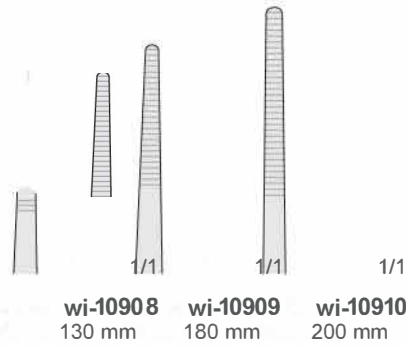

wi-10915

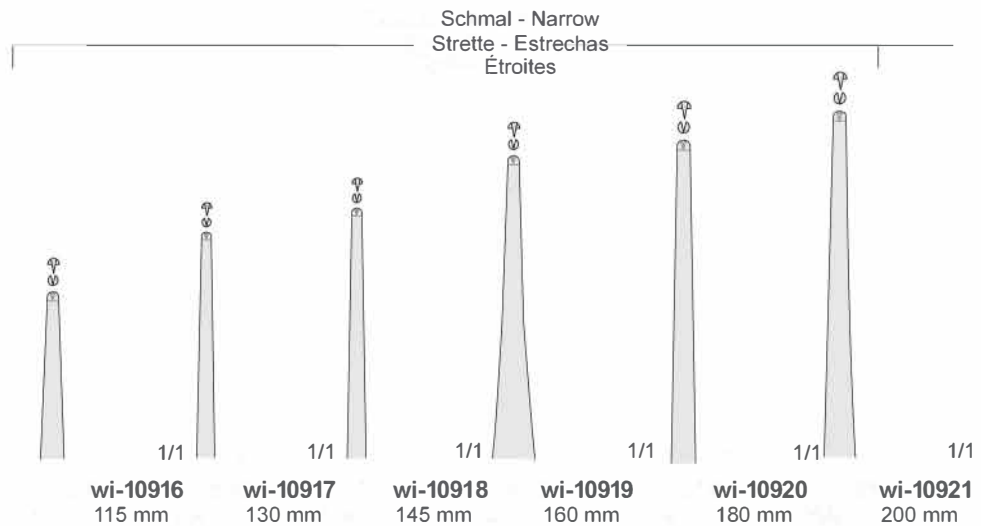

1x2 Zähne
 1x2 Teeth
 1x2 Denti
 1x2 Dientes
 1x2 Dents

wi-10921



TC
TUNGSTEN
CARBIDE

Tungsten-Carbide Inserts
Mit Hartmetalleinsätzen
Plaquettes en carbure de tungstène
Plaquetas de carburo de tungsteno
Inserti in carburo di tungsteno

Nadelhalter
Needle Holders
Port'aghi
Portaagujas
Porte aiguilles

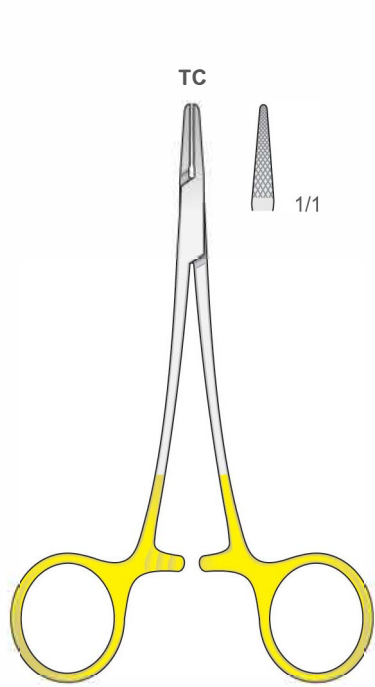

wi-10922
120 mm

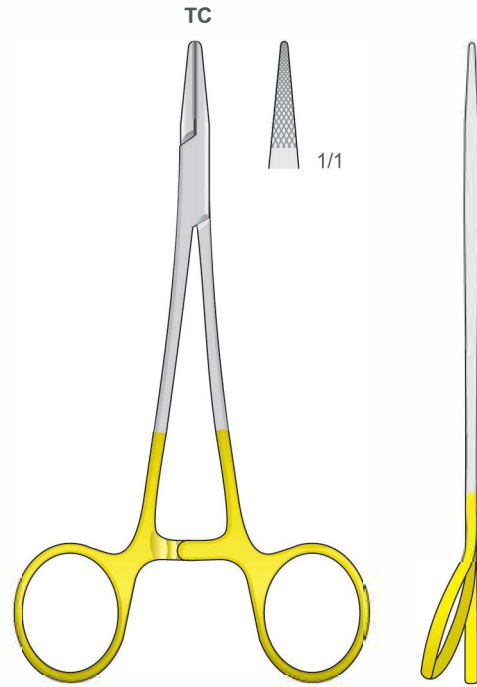

CRILE-WOOD
wi-10923
150 mm

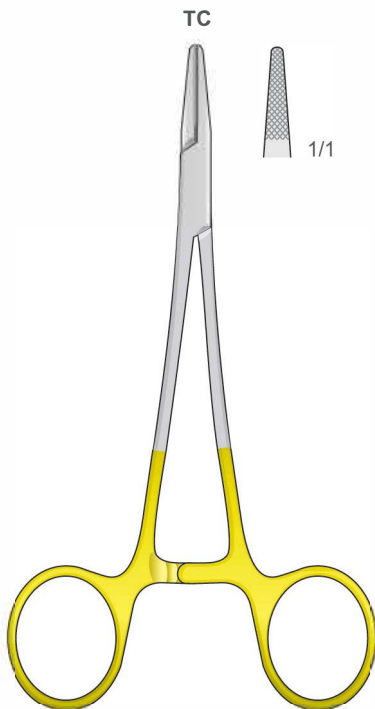

**BABY-CRILE-
WOOD wi-10924**
150 mm

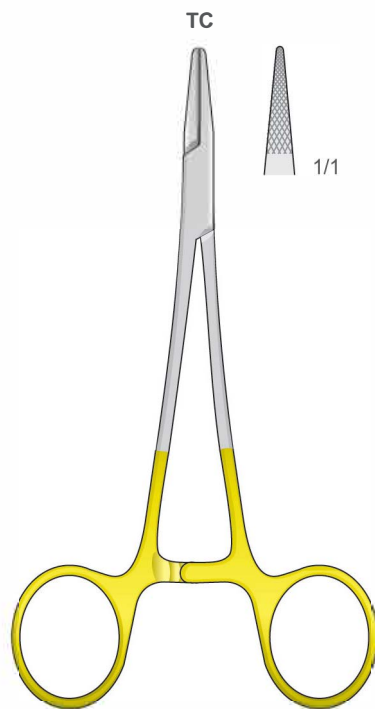

CRILE-WOOD
wi-10925
150 mm



CRILE-WOOD
wi-10926
150 mm



Nadelhalter
Needle Holders
Port'aghi
Portaaguja
Porte aiguilles

TC
TUNGSTEN
CARBIDE

Tungsten-Carbide Inserts
Mit Hartmetalleinsätzen
Plaquettes en carbure de tungstène
Plaquetas de carburo de tungsteno
Inserti in carburo di tungsteno

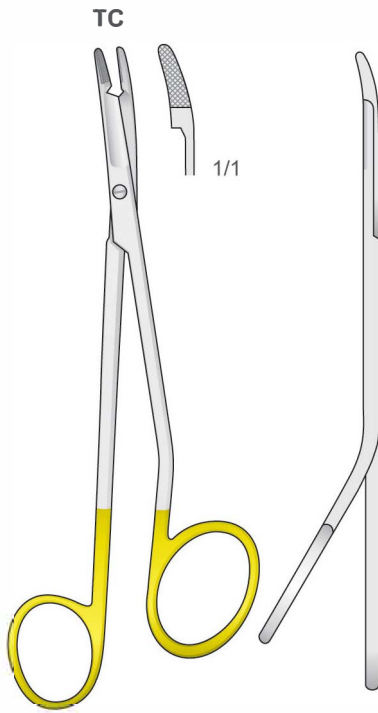

MINI-GILLIES
wi-10927
145 mm

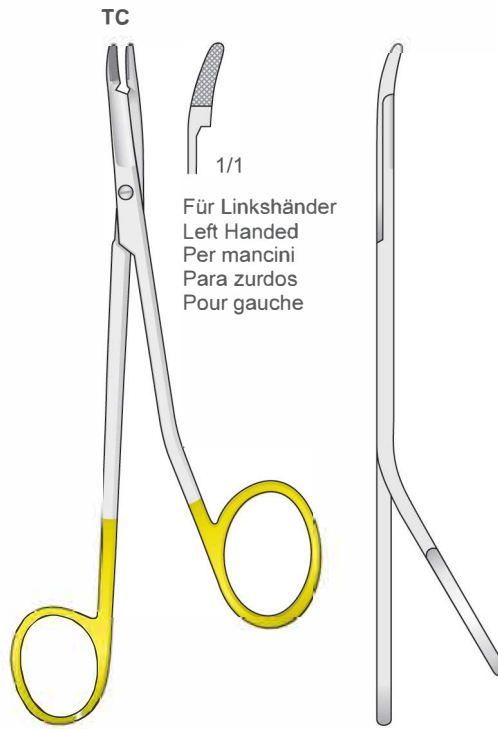

MINI-GILLIES
wi-10928
145 mm

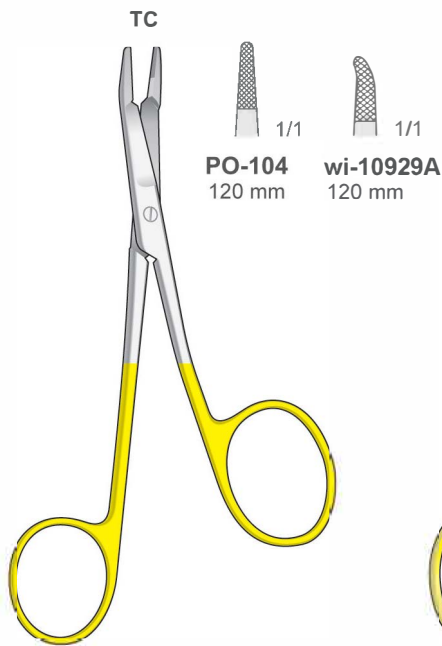

FOSTER-GILLIES
wi-10929
120 mm

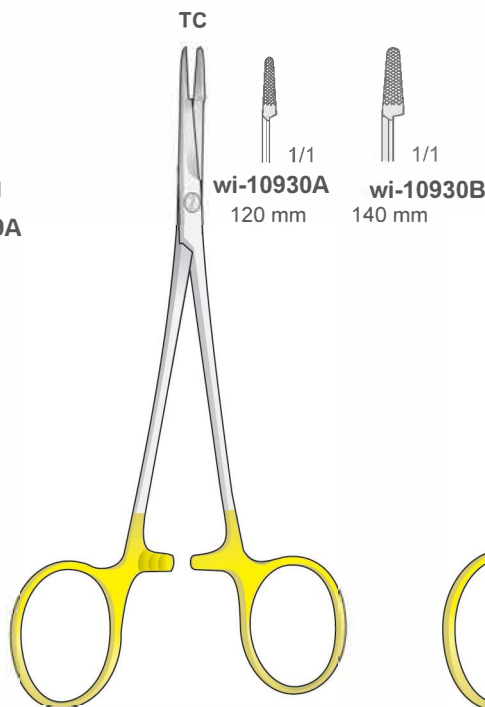

OLSEN-HEGAR
wi-10930

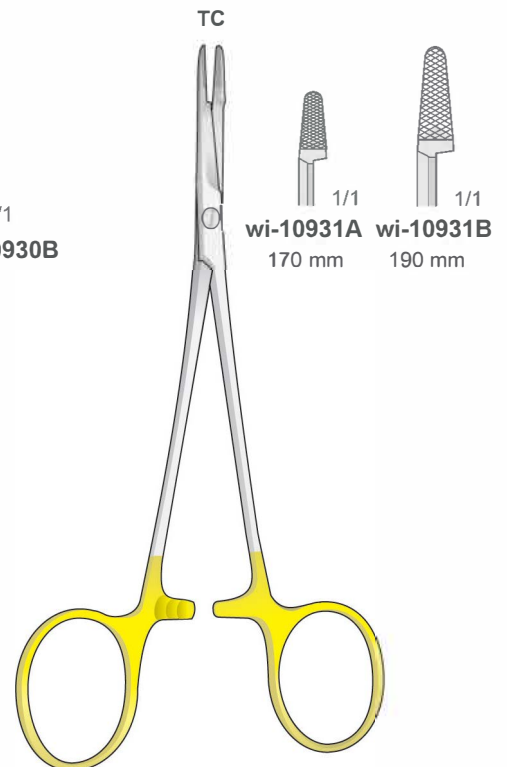

OLSEN-HEGAR
wi-10931



Nadelhalter
Needle Holders
Port'aghi
Portaagujas
Porte aiguilles

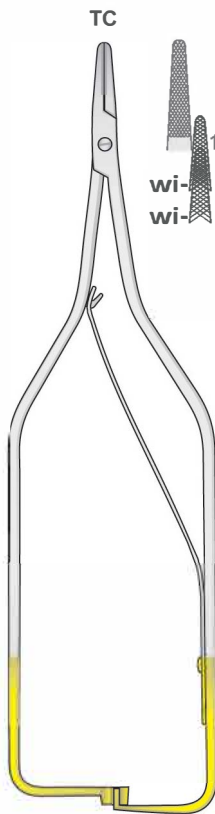

ARUGA
wi-0937
160 mm

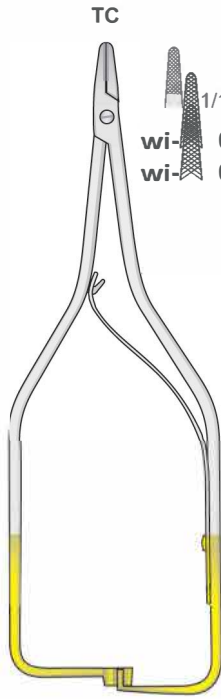
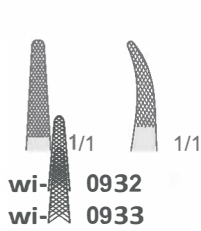

BOYNTON
wi-0938
120 mm

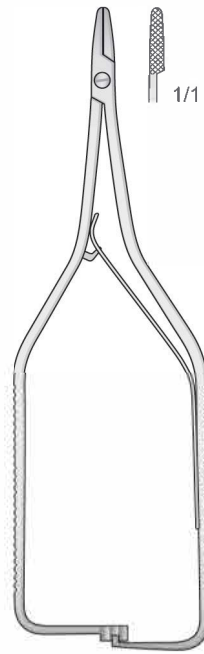

BOYNTON
wi-0939
120 mm

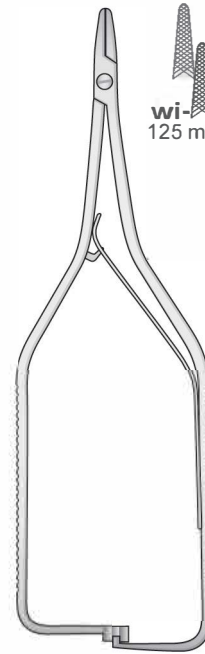

BOYNTON
wi-0940
125 mm

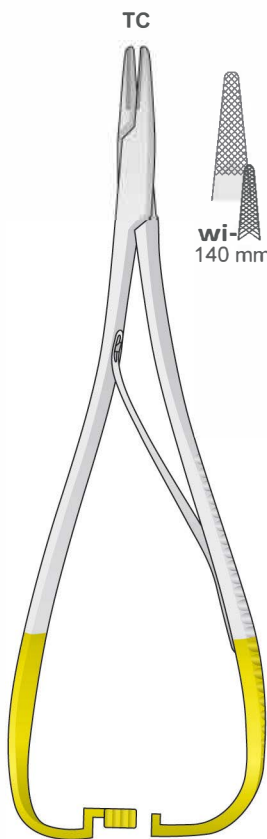

MATHIEU
wi-0945

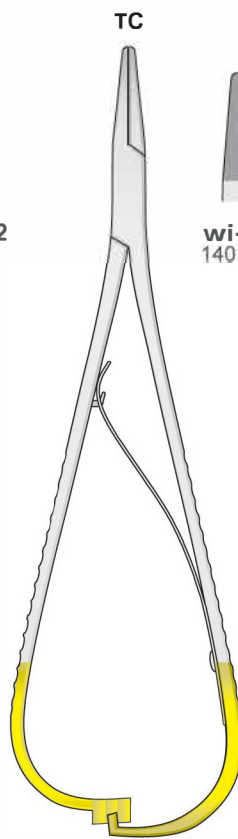
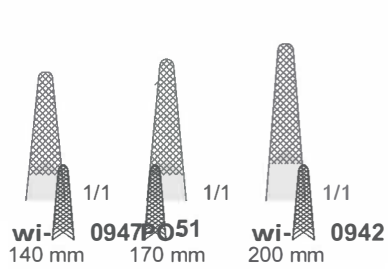

MATHIEU
wi-0946

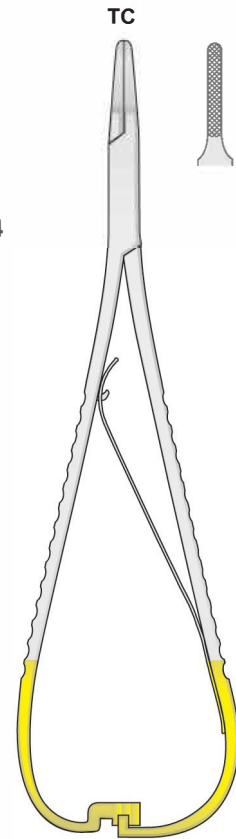
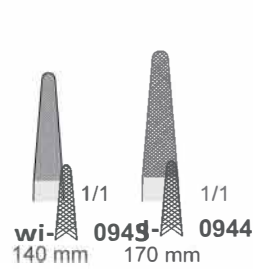

LICHTENBERG
wi-0947
175 mm

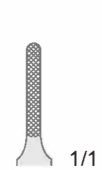



Nadelhalter
Needle Holders
Port'aghi
Portaagujas
Porte aiguilles

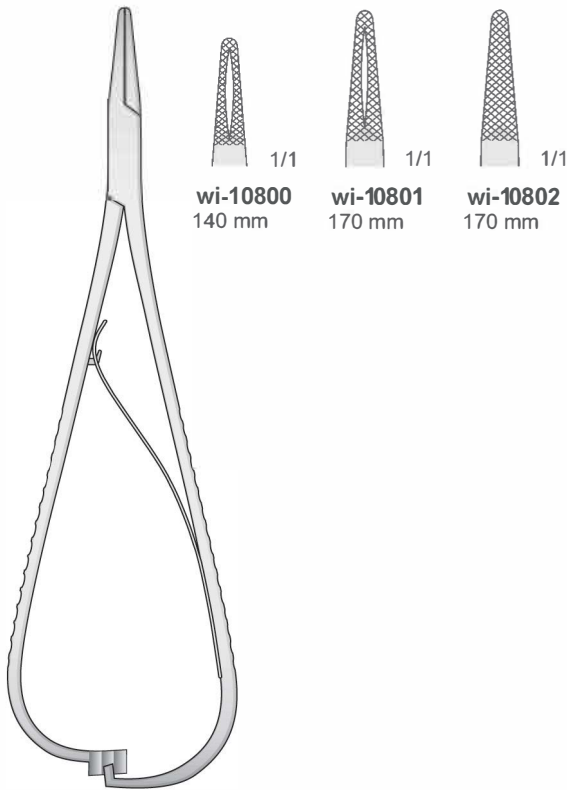

MATHIEU
wi-10805

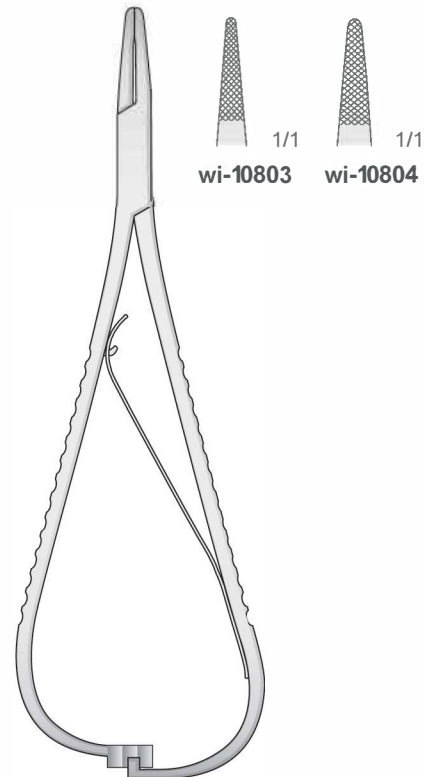

MATHIEU
wi-10806
140 mm

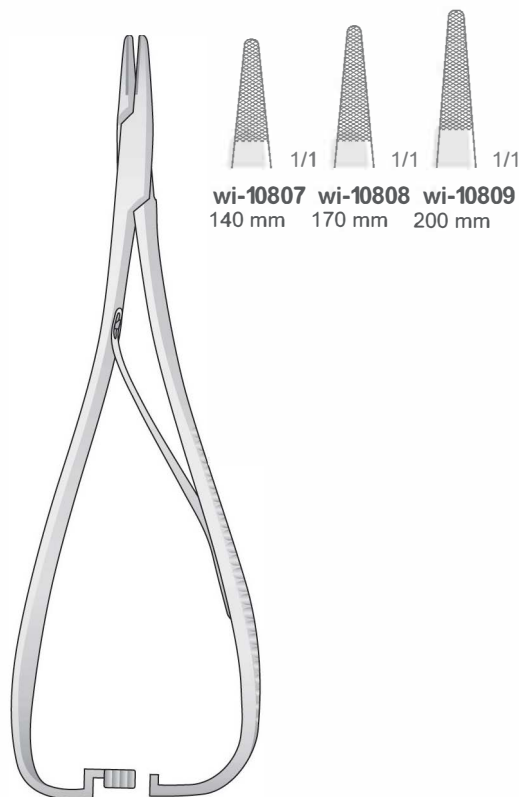

MATHIEU
wi-10810

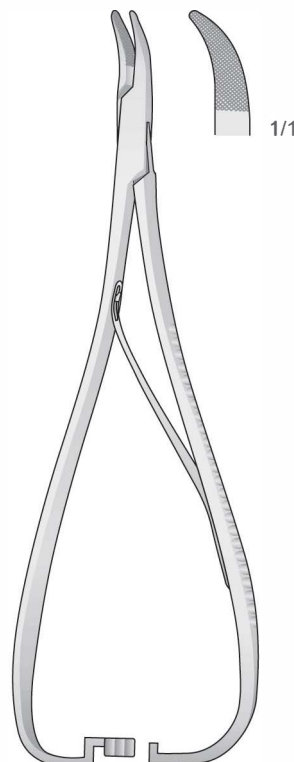

wi-10811
140 mm



Nadelhalter
Needle Holders
Port'aghi
Portaagujas
Porte aiguilles

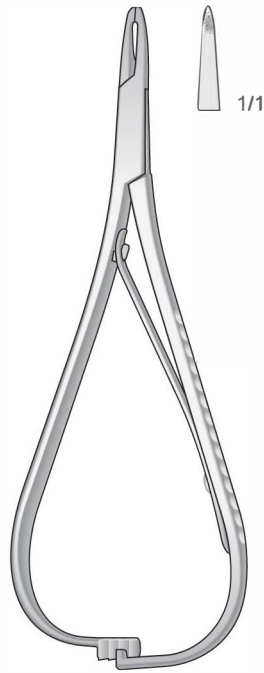

MATHIEU
wi-10815
125 mm

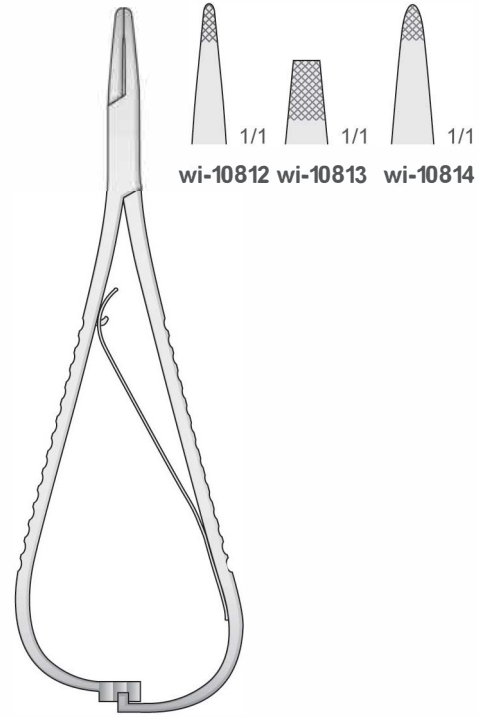

MATHIEU
wi-10816
140 mm

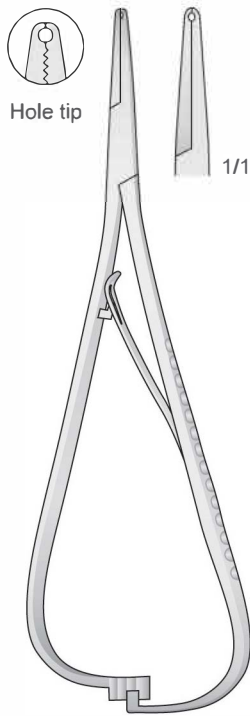

SMAHA
wi-10817
140 mm

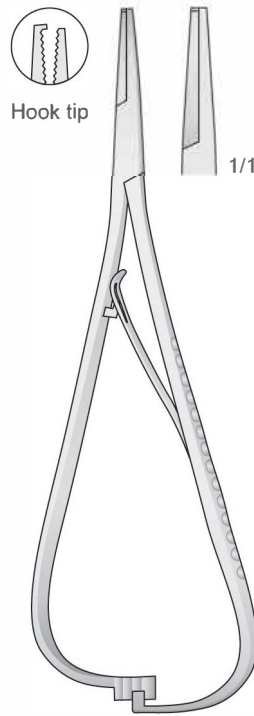

SMAHA
wi-10818
140 mm

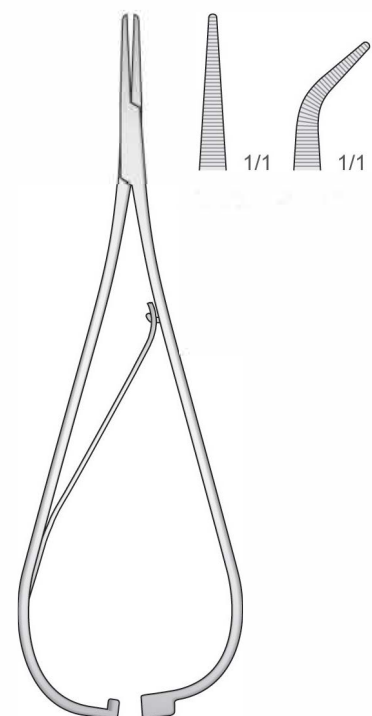

SMAHA
wi-10819
140 mm



Tuchklemmen
Towel Clamps
Fissateli
Pinzas de campo
Pinces fixe-compresses

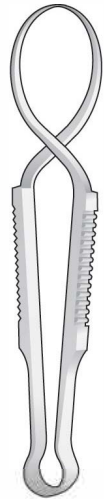

SCHAEDEL
wi-10820
85 mm

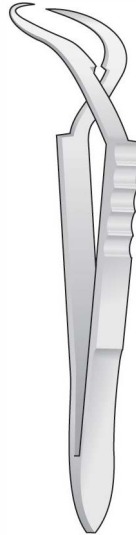

JONES
wi-10821
90 mm



FAURE
wi-10822
85 mm

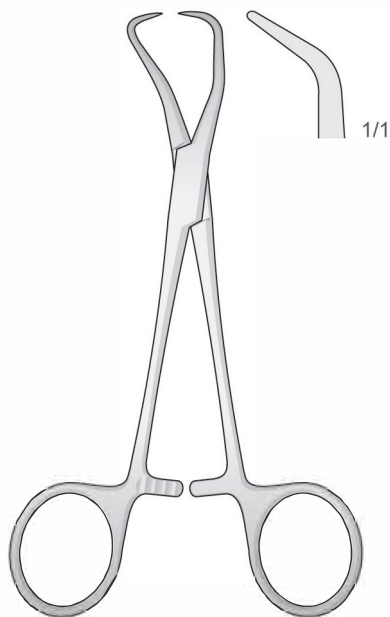

BACKHAUS
wi-10829

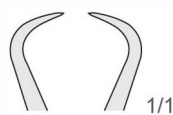

wi-108233
90 mm

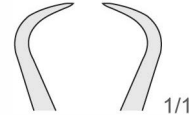

wi-10824
100 mm



wi-10825
110 mm

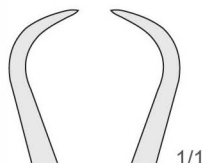

wi-10826
130 mm

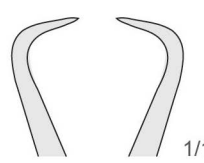

wi-10827
135 mm

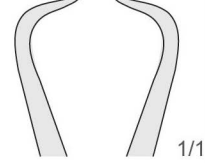

wi-10828
140 mm



Tuchklemmen
Towel Clamps
Fissateli
Pinzas de campo
Pincés fixe-compresses

Für Papiertücher
For paper cloths
Per teli di carta
Para paños
Pour papier

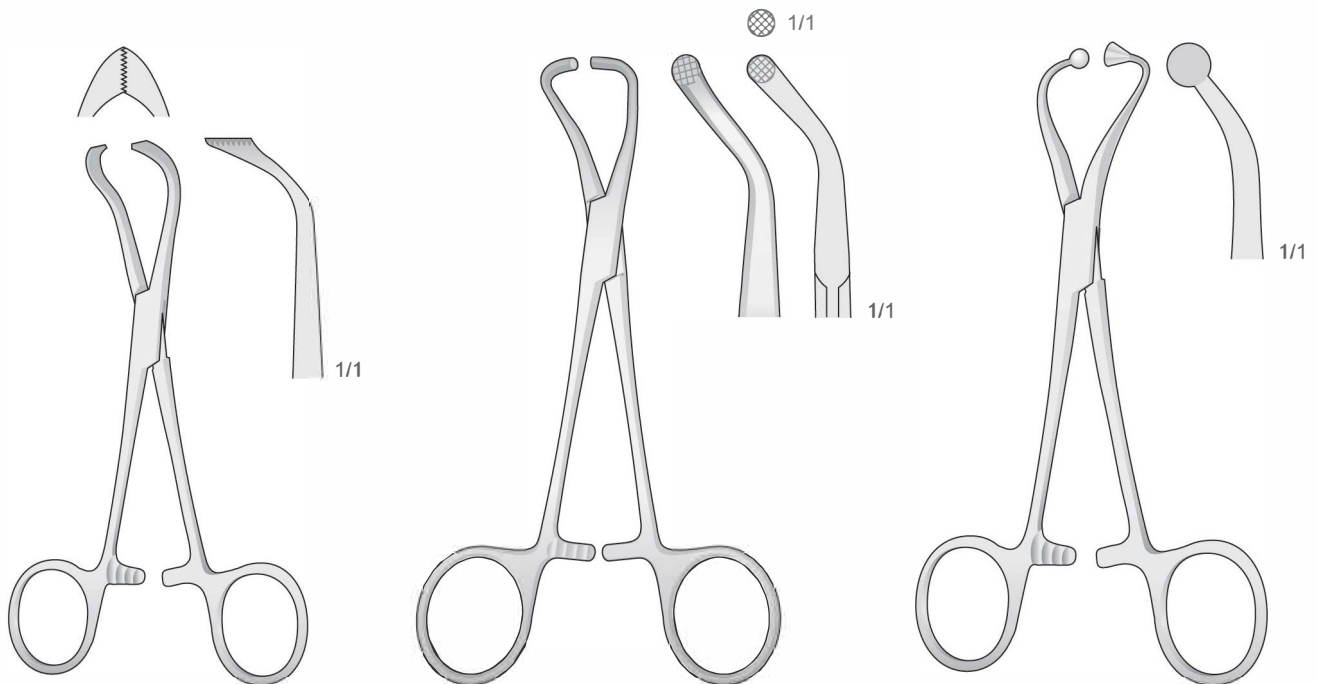

LORNA
wi-10830
100 mm

wi-10831
130 mm

wi-10832
140 mm



Arterienklemmen
 Hemostatic Forceps
 Pinze emostatiche
 Pinzas hemostáticas
 Pinces hémostatiques

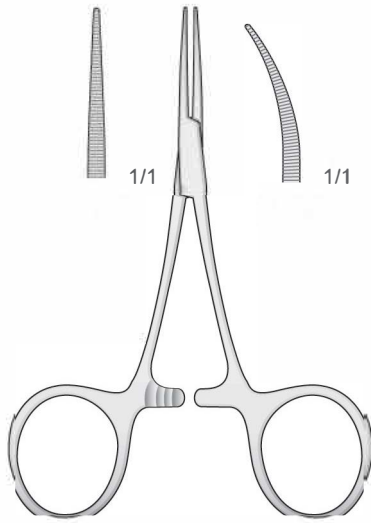

HARTMANN/BABY-MOSQUITO
wi-10833
 95 mm

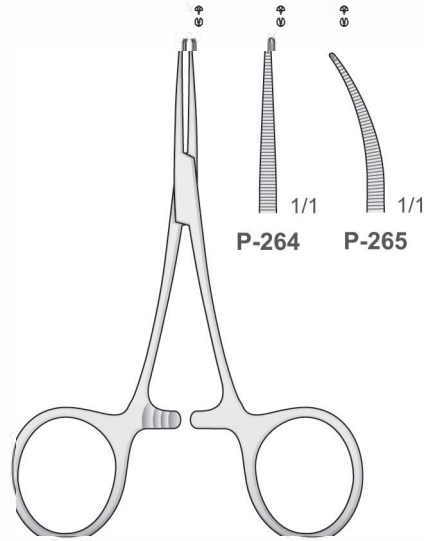

HARTMANN/BABY-MOSQUITO
wi-10834
 95 mm

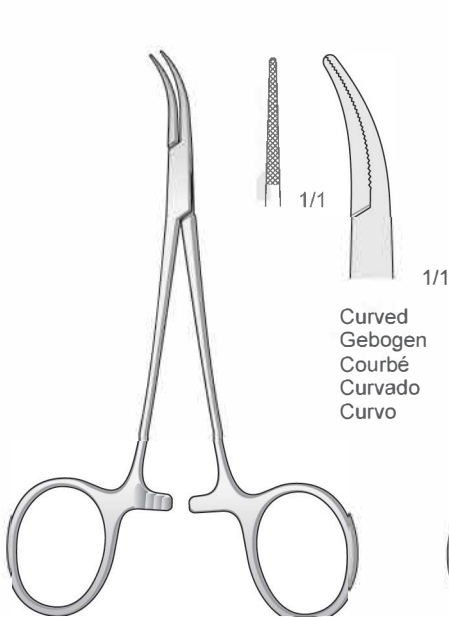

DANDY-MOSQUITO
wi-10835
 120 mm

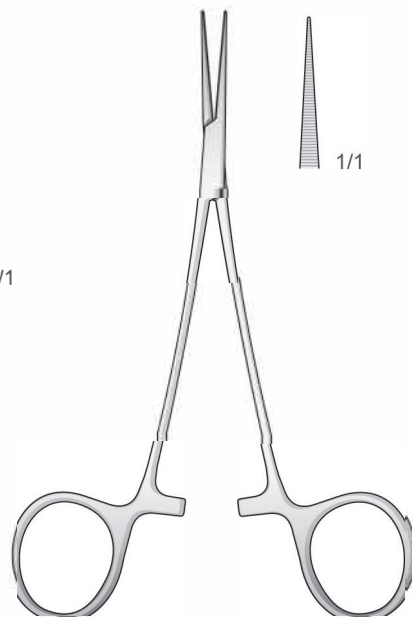

JACOBSON-MICRO
wi-10836
 130 mm

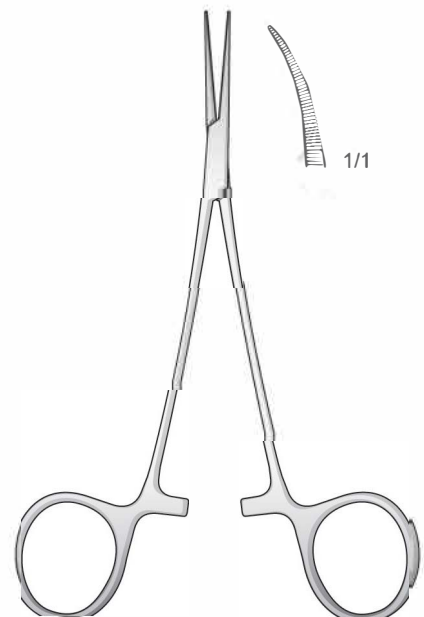

JACOBSON-MICRO
wi-10837
 130 mm

Curved
 Gebogen
 Courbé
 Curvado
 Curvo



Arterienklemmen
 Hemostatic Forceps
 Pinze emostatiche
 Pinzas hemostáticas
 Pincés hémostatiques

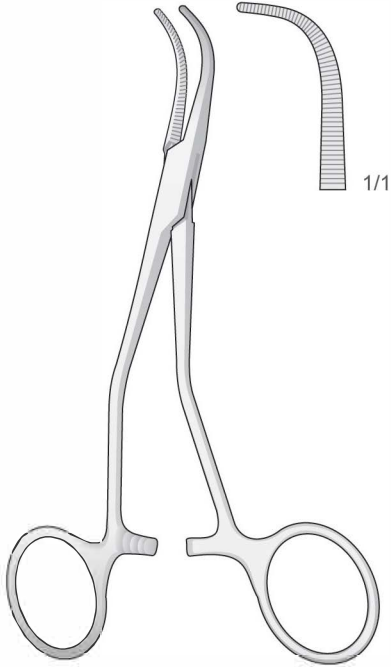

wi-10838
 130 mm



PEET
wi-10839
 120 mm

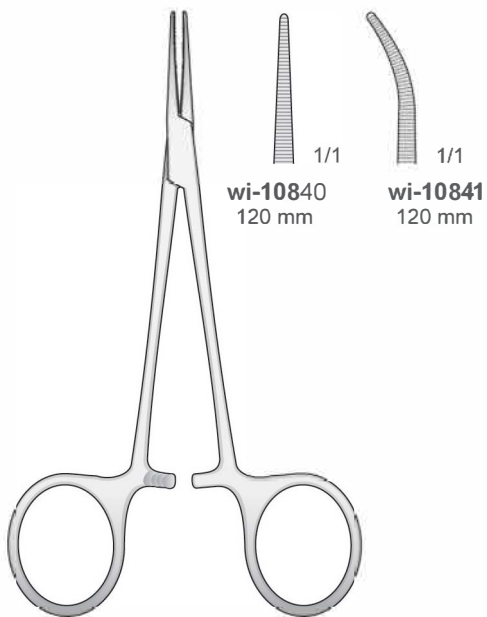

MICRO-HALSTED
wi-10842

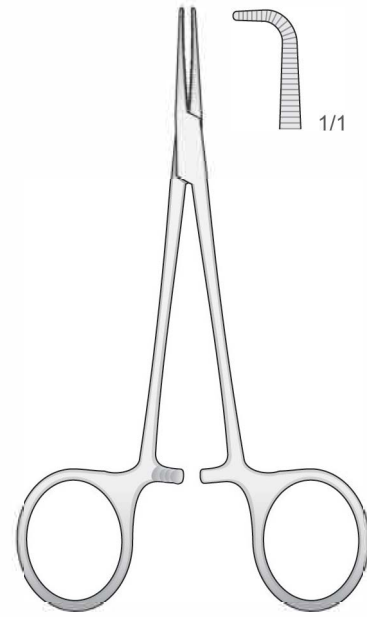

MICRO-HALSTED
wi-10843
 115 mm



Arterienklemmen

Hemostatic Forceps
Pinze emostatiche
Pinzas hemostáticas
Pinces hémostatiques

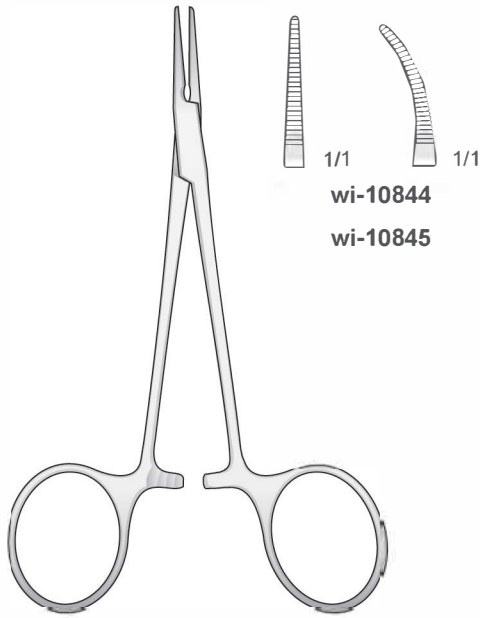

wi-10844
wi-10845

HALSTED
wi-10848
125 mm

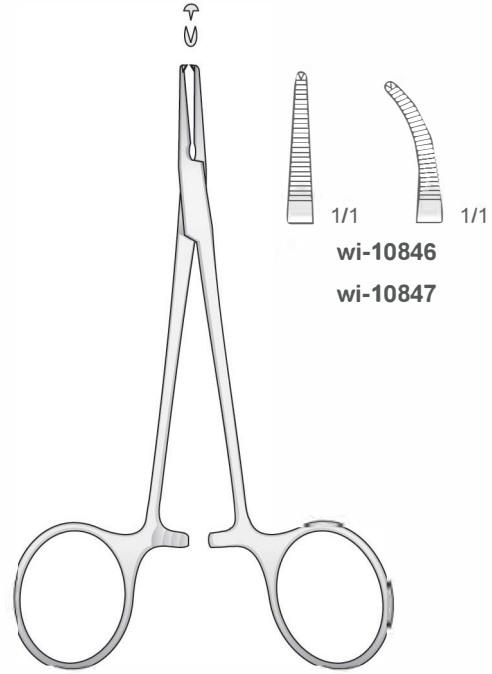

wi-10846
wi-10847

HALSTED
wi-10849
125 mm

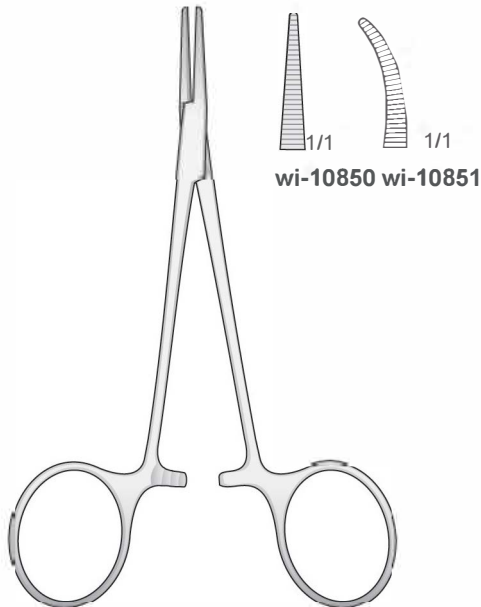

wi-10850 **wi-10851**

HALSTED-MOSQUITO
wi-10854
120 mm

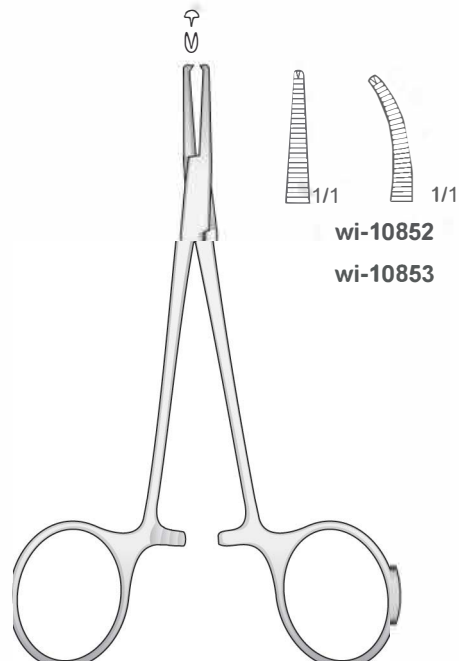

wi-10852
wi-10853

HALSTED-MOSQUITO
wi-10855
120 mm



Arterienklemmen
 Hemostatic Forceps
 Pinze emostatiche
 Pinzas hemostáticas
 Pincas hémostatiques

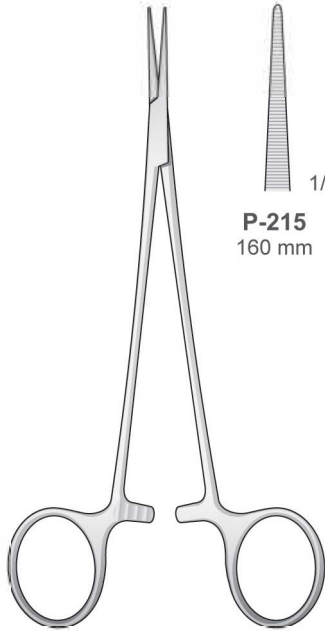

wi-10860
160 mm

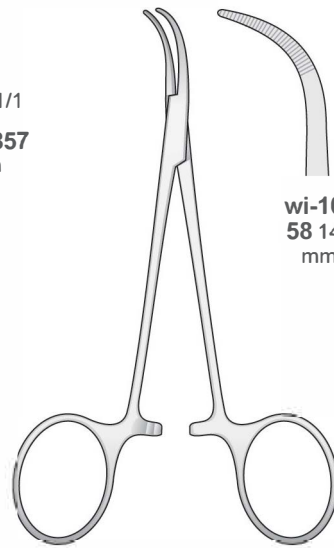
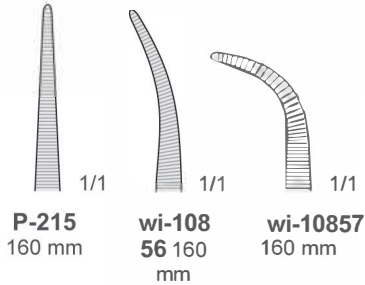

BABY-MIXTER
wi-10861

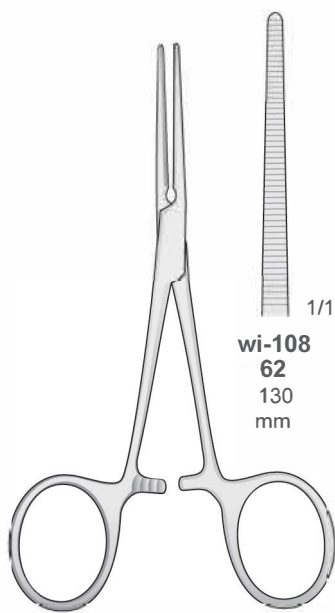
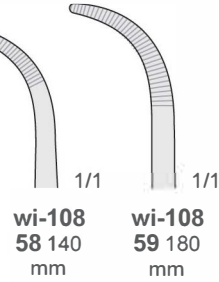

PEAN
wi-10870

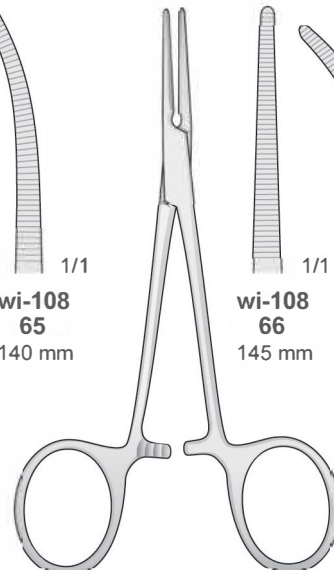
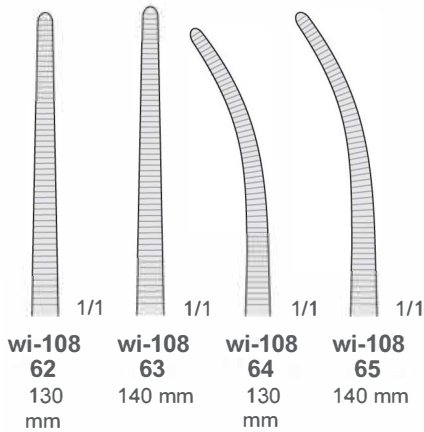

PEAN
wi-10871

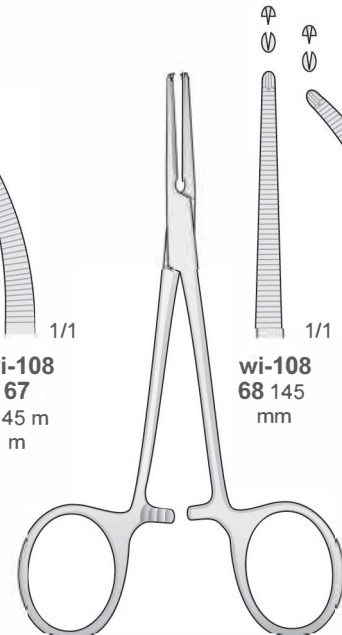
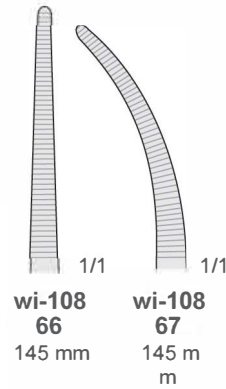

KOCHER
wi-10872

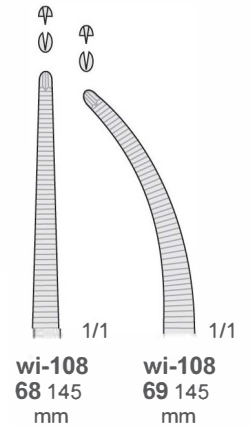



Arterienklemmen
 Hemostatic Forceps
 Pinze emostatiche
 Pinzas hemostáticas
 Pincas hémostatiques

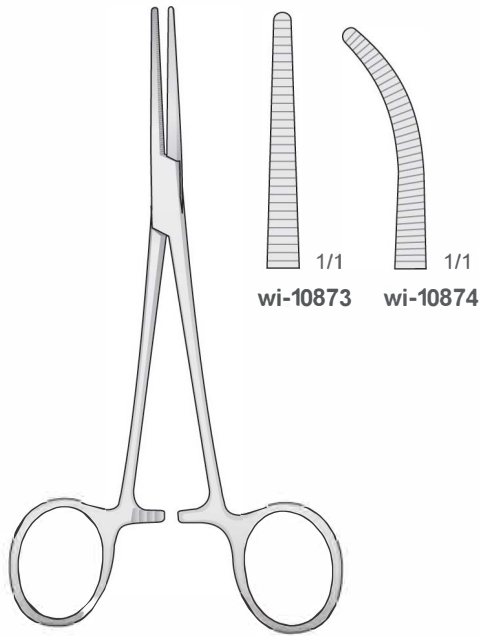

CRILE
wi-10877
 140 mm

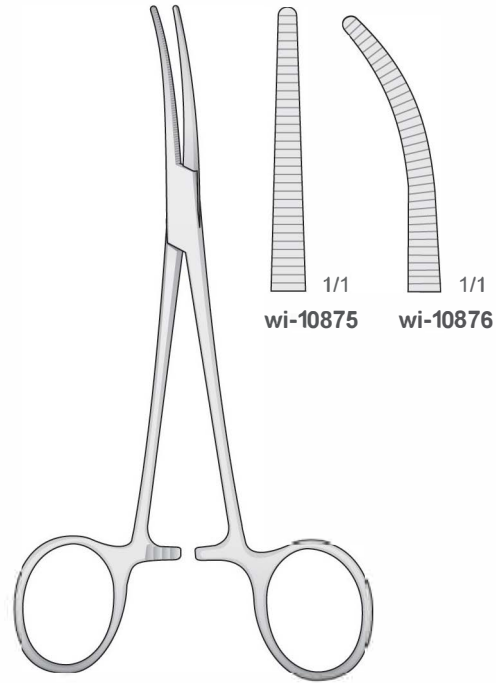

CRILE
wi-10878
 160 mm

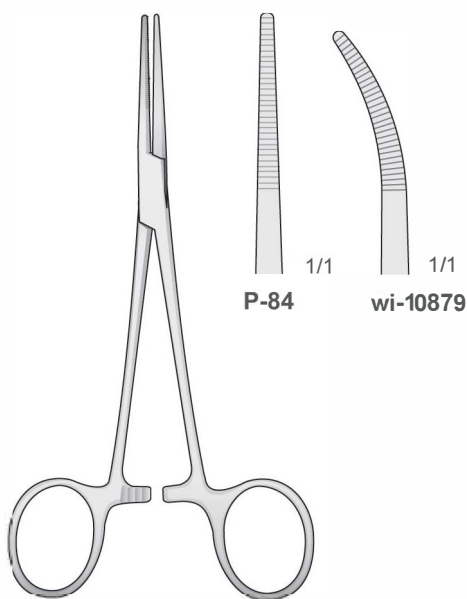

KELLY
wi-10883
 140 mm

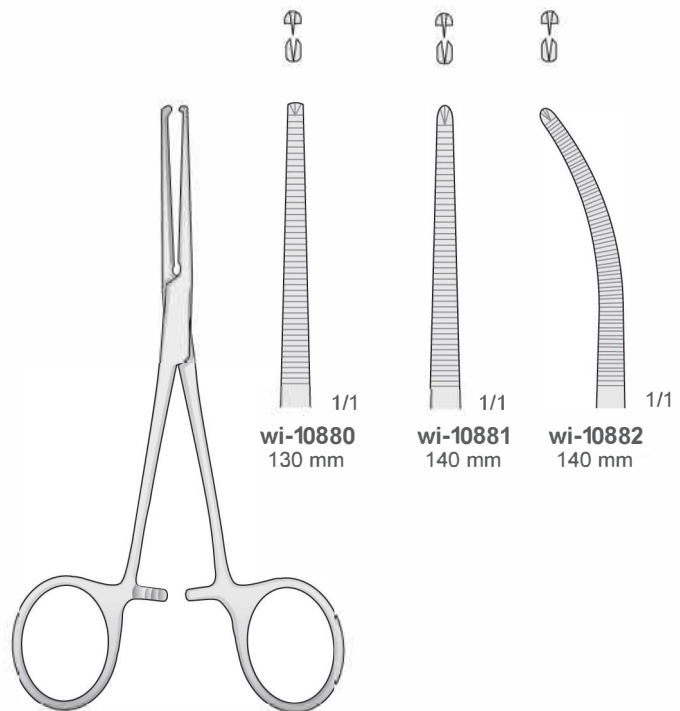

KOCHER
wi-10884



Arterienklemmen
 Hemostatic Forceps
 Pinze emostatiche
 Pinzas hemostáticas
 Pincas hémostatiques

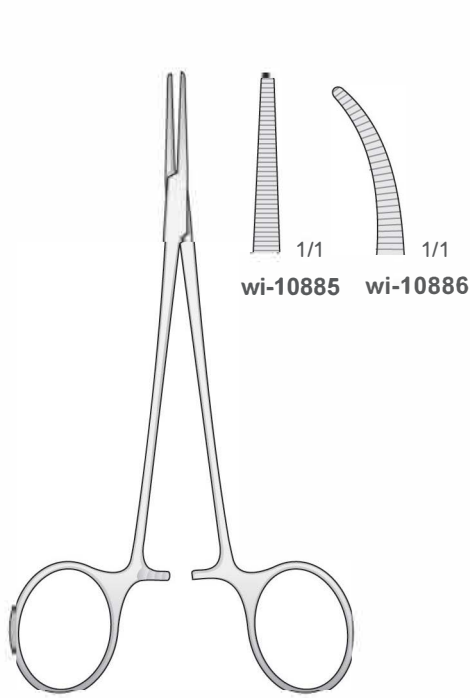

LERICHE
wi-10889
 150 mm

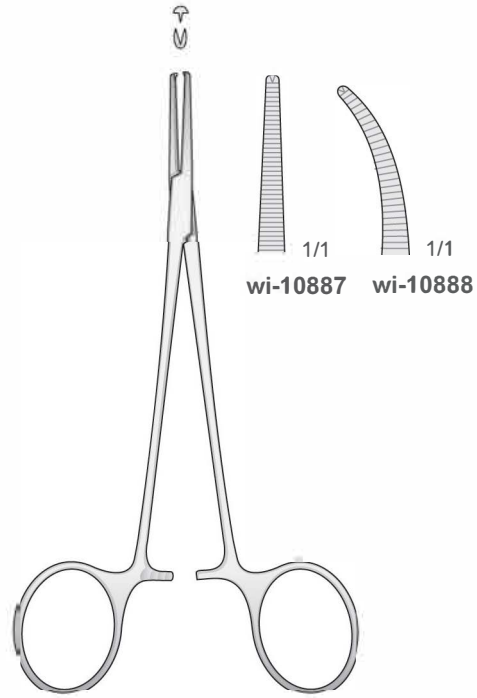

LERICHE
wi-10890
 150 mm

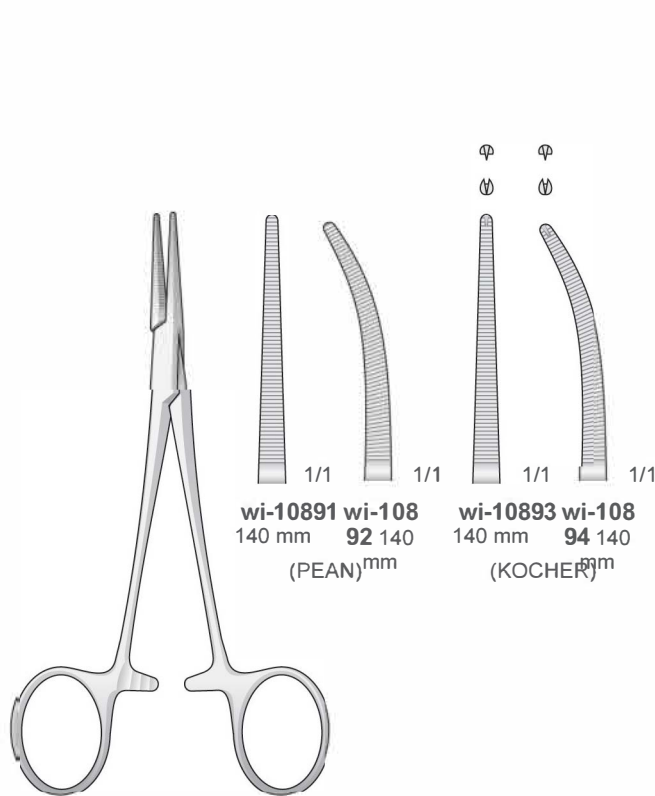

BABY-CRILE
wi-10899
 140 mm

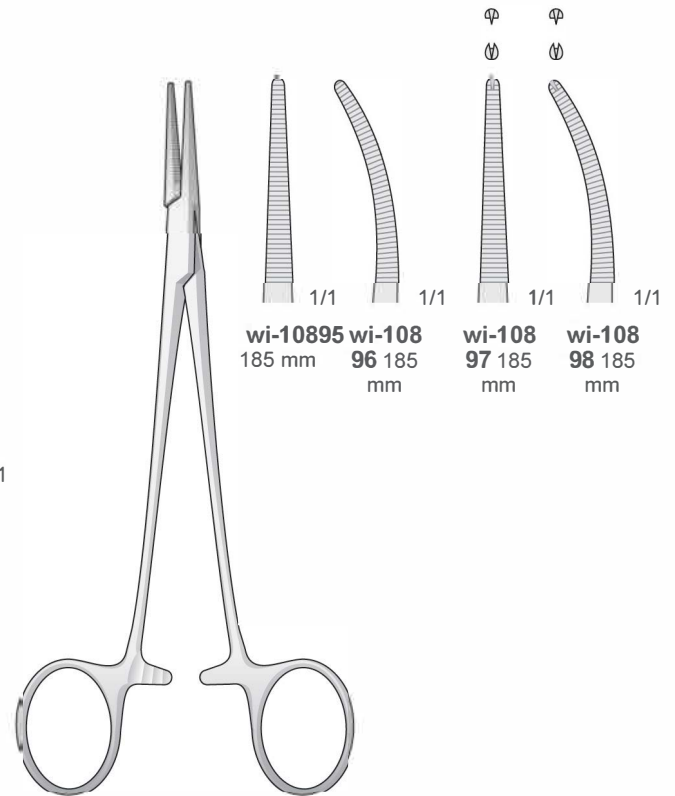

HALSTED
wi-10900
 185 mm



Wundhaken
Retractors
Divaricatori
Separadores
Écarteurs



JOSEPH
wi-10906
160 mm

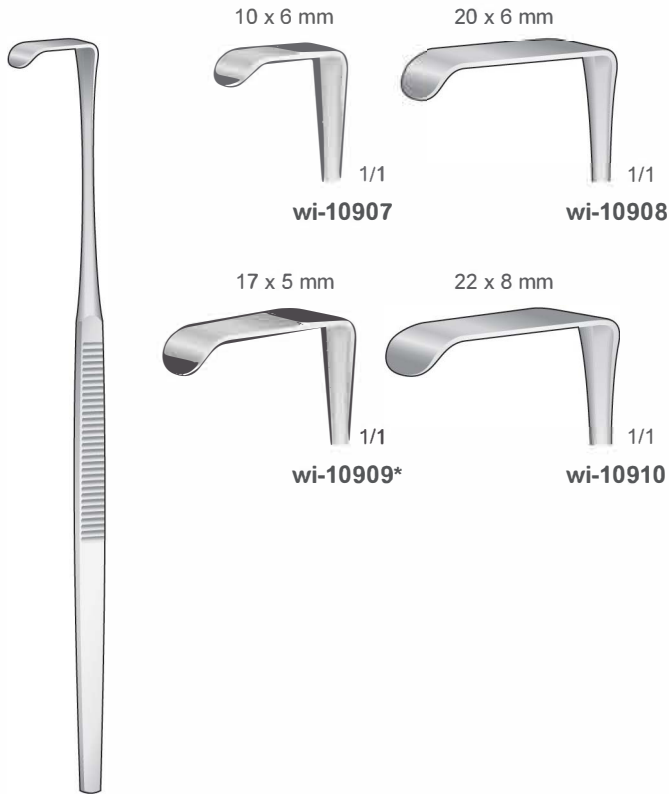
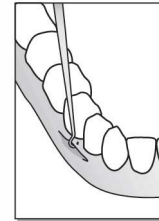
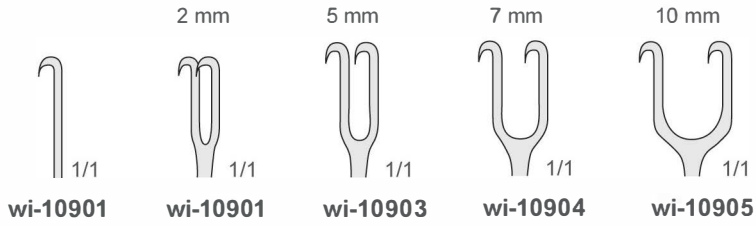

MINI-LANGENBECK
wi-10911
160 mm

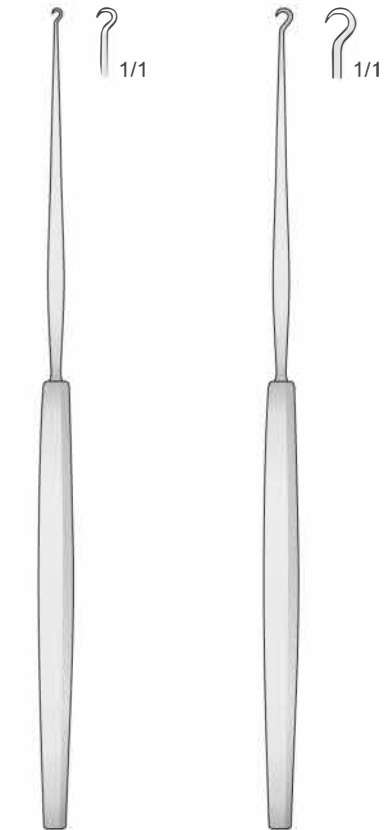

GILLIES
wi-10912
180 mm

GILLIES
wi-10913
180 mm



Wundhaken
Retractors
Divaricatori
Separadores
Écarteurs

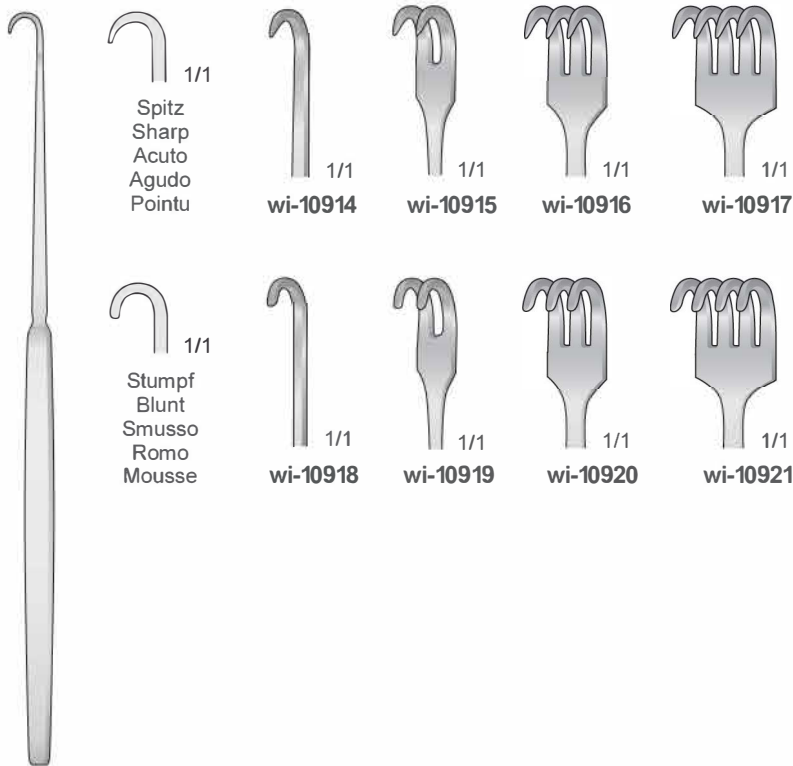

1/1
Spitz
Sharp
Acuto
Agudo
Pointu

1/1
wi-10914

1/1
wi-10915

1/1
wi-10916

1/1
wi-10917

1/1
Stumpf
Blunt
Smusso
Romo
Mousse

1/1
wi-10918

1/1
wi-10919

1/1
wi-10920

1/1
wi-10921

wi-10921A
160 mm

Feine wundhaken flexibel-spitz
Delicate retractors flexible-sharp
Divaricatori delicati flessibili-acuti
Separadores finos flexibles-agudos
Écarteurs fins pointu flexible

Feine wundhaken flexibel-stumpf
Delicate retractors flexible-blunt
Divaricatori delicati flessibili-smussi
Separadores finos flexibles-romos
Écarteurs fins mousse flexible



wi-10922
150 mm

wi-10923
150 mm

wi-10924
150 mm

wi-10925
150 mm

wi-10926
150 mm

wi-10927
150 mm



Wundhaken
Retractors
Divaricatori
Separadores
Écarteurs

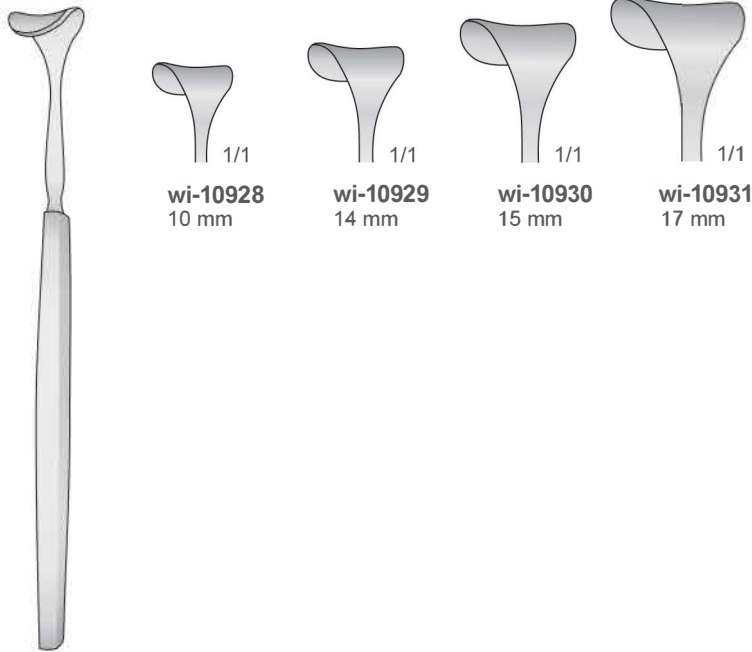

1/1
wi-10928
10 mm

1/1
wi-10929
14 mm

1/1
wi-10930
15 mm

1/1
wi-10931
17 mm

DESMARRES
wi-10932
140 mm

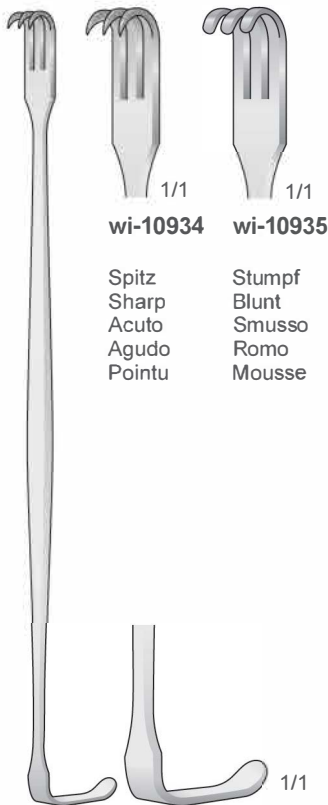

1/1
wi-10934

1/1
wi-10935

Spitz
Sharp
Acuto
Agudo
Pointu

Stumpf
Blunt
Smusso
Romo
Mousse

SEÁN-MILLER
wi-10938
160 mm



1/1
wi-10936
19 x 12 mm

1/1
wi-10937
21 x 14 mm

KOCHER
wi-10938
205 mm

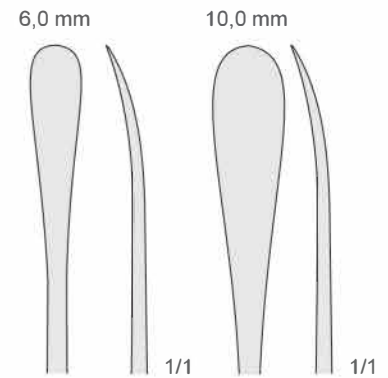

6,0 mm

10,0 mm

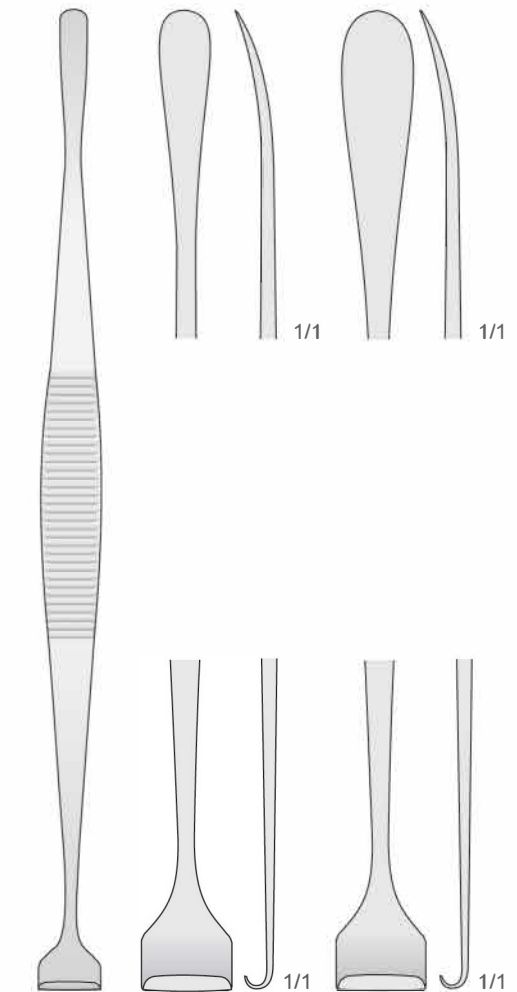

HURD
wi-10939
220 mm

12 mm

12 mm



Wundhaken
Retractors
Divaricatori
Separadores
Écarteurs

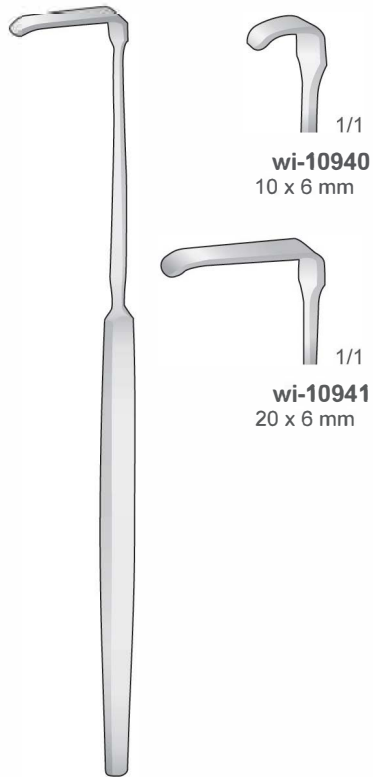

SENN GREEN
wi-10942
160 mm

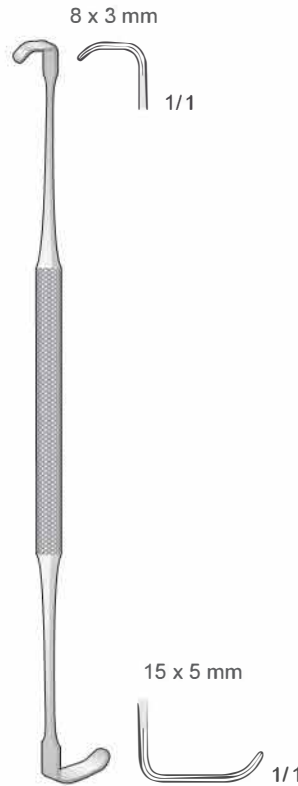

RAGNELL
wi-10943
140 mm

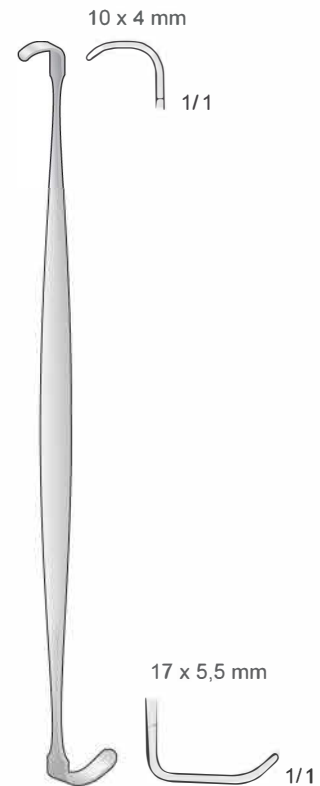

RAGNELL-DAVIS
wi-10944
140 mm

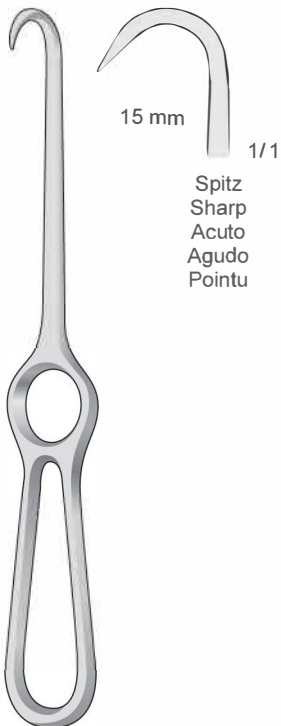

KOCHER
wi-10945
205 mm

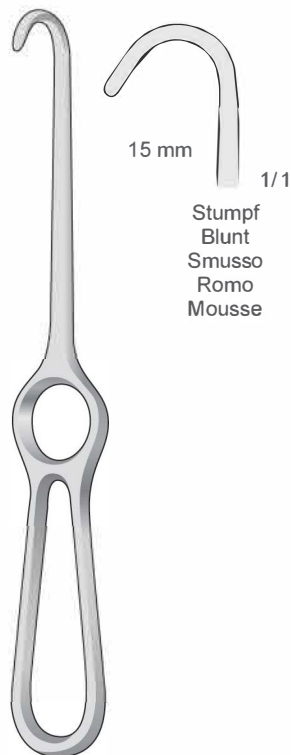

KOCHER
wi-10946
220 mm



LAHEY
wi-10947
195 mm

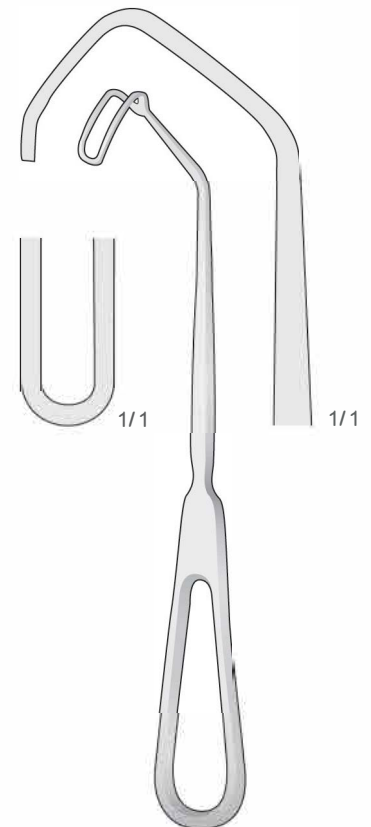

CUSHING
wi-10948
200 mm



Wundhaken
 Retractors
 Divaricatori
 Separadores
 Écarteurs

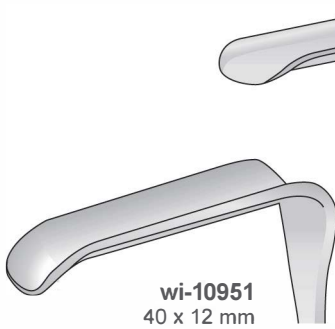
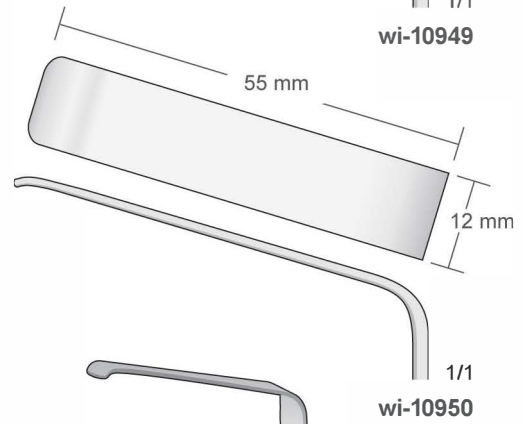
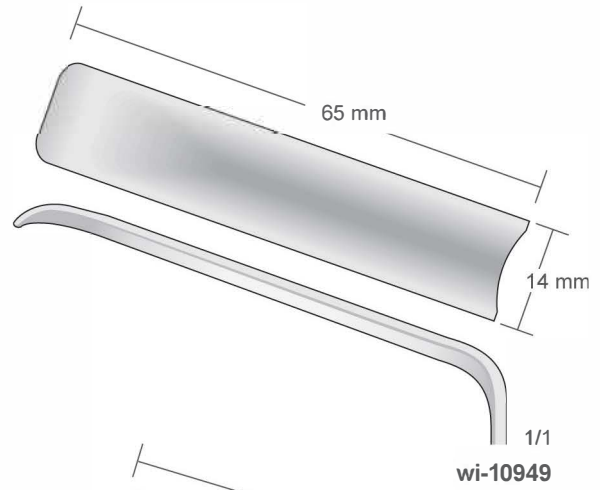



Wundhaken
Retractors
Divaricatori
Separadores
Écarteurs

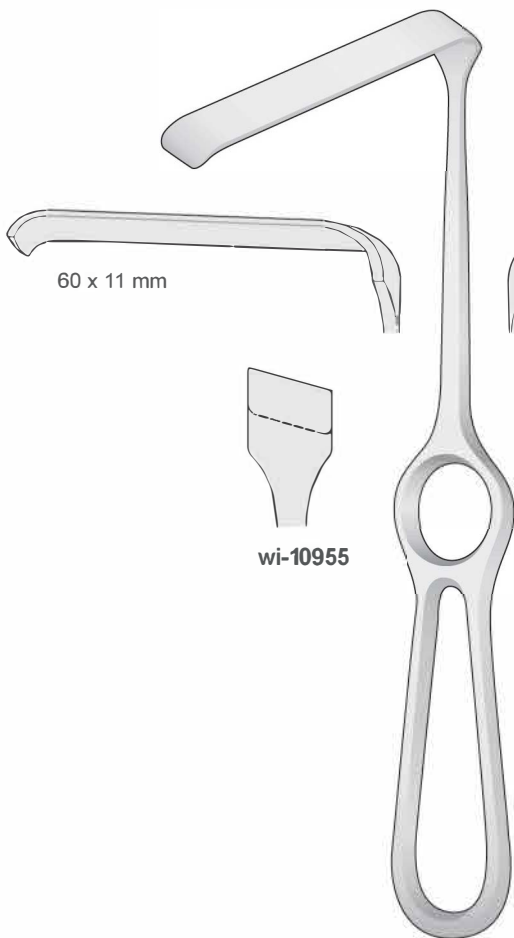

60 x 11 mm

wi-10955

KIRSCH
wi-10960
210 mm

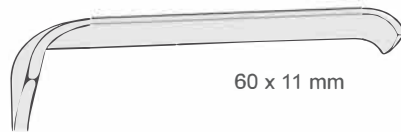

60 x 11 mm

wi-10956

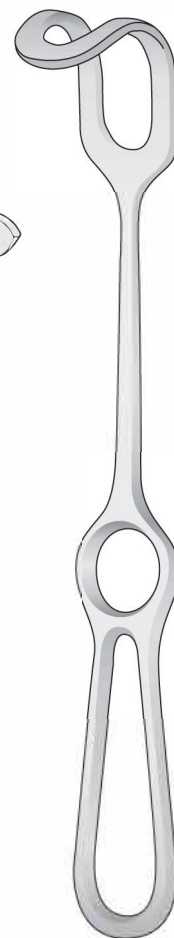

MIDDELDORPF
wi-10961
225 mm

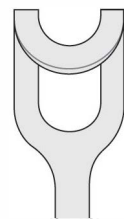

wi-10957
15 x 15 mm

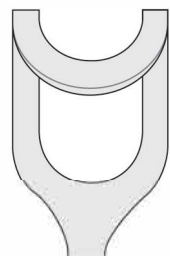

wi-10958
20 x 22 mm

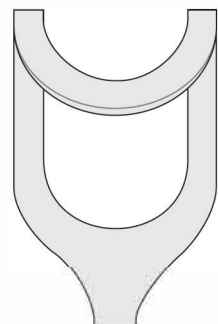

wi-10959
28 x 28 mm



Wundhaken
 Retractors
 Divaricatori
 Separadores
 Écarteurs



OBWEGESER
wi-10962
 220 mm

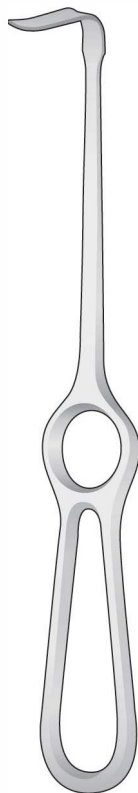

OBWEGESER
wi-10975
 220 mm



wi-10963
 25 x 7 mm

1/1



wi-10964
 31 x 10 mm

1/1

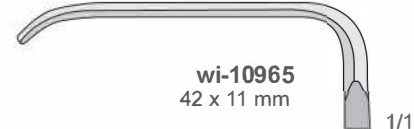

wi-10965
 42 x 11 mm

1/1

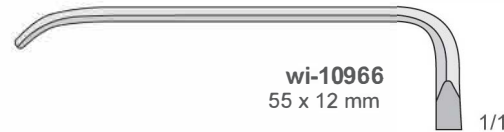

wi-10966
 55 x 12 mm

1/1



wi-10967
 70 x 14 mm

1/1



wi-10968
 80 x 16 mm

1/1



wi-10969
 25 x 7 mm

1/1



wi-10970
 31 x 10 mm

1/1

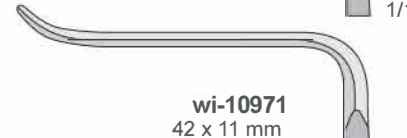

wi-10971
 42 x 11 mm

1/1

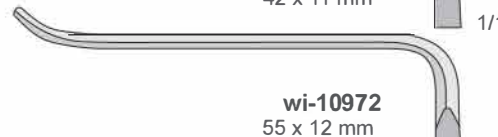

wi-10972
 55 x 12 mm

1/1



wi-10973
 70 x 14 mm

1/1



wi-10974
 80 x 16 mm

1/1



Wundhaken
 Retractors
 Divaricatori
 Separadores
 Écarteurs

Rostfrei - Stainless Steel
 Acciaio - Acero - Acer

Biegsam - Malleable
 Malleabili - Maleables
 Souples

wi-10976
 Komplettsset mit 3 Spatel
 Set complete with 3 spatulas
 Set completo con 3 spatole
 Set completos con 3 espátulas
 Set complete avec 3 spatules
OM-80 + OM-81 + OM-82

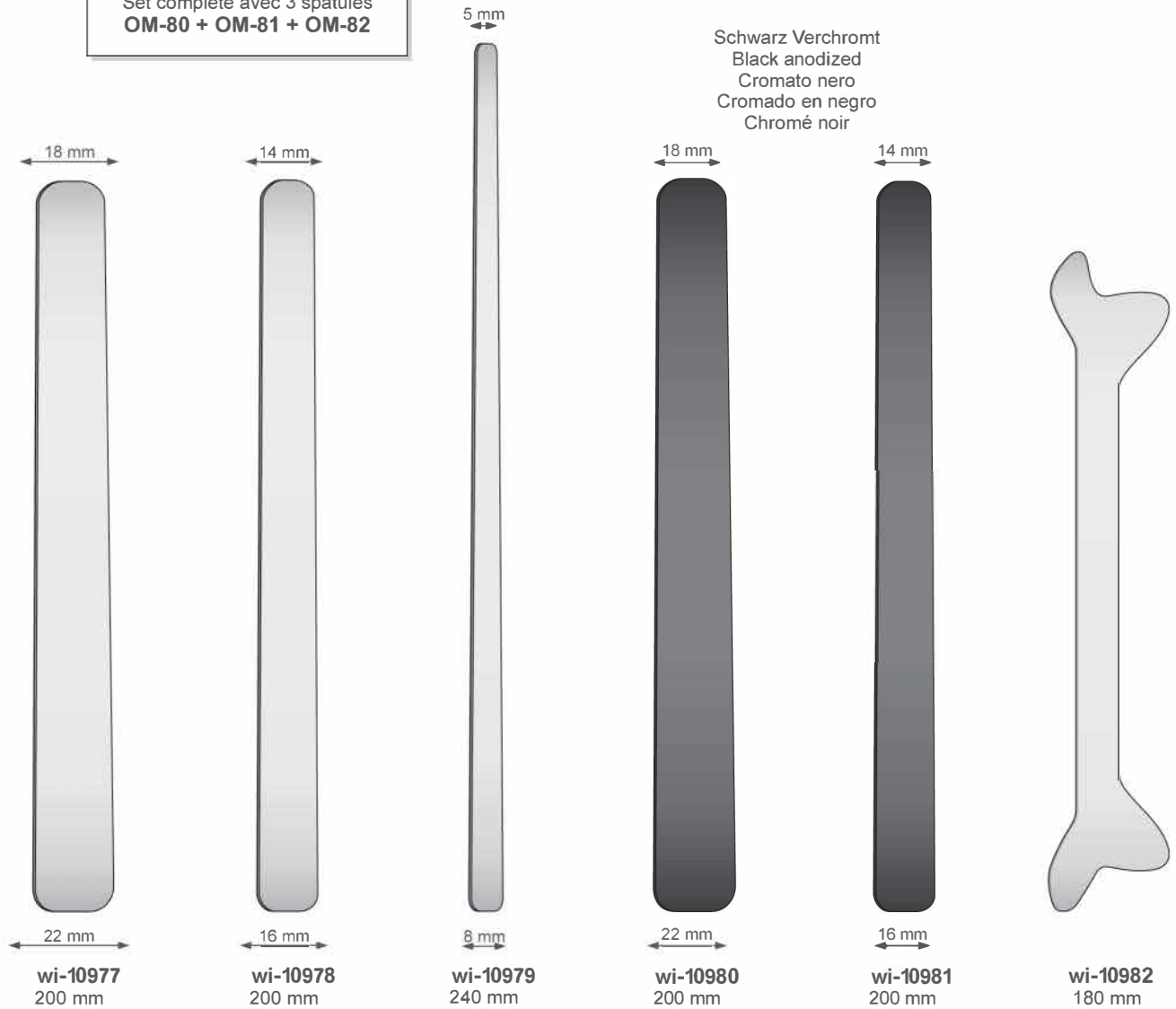



Wundhaken
Retractors
Divaricatori
Separadores
Écarteurs

Zungendrucker
Tongue Depressors
Abbassalingua
Bajalengua
Abaisse langue

Kinnhalter
Chin Holder
Divaricatore per mento
Separador para mentón
Écarteur pour menton

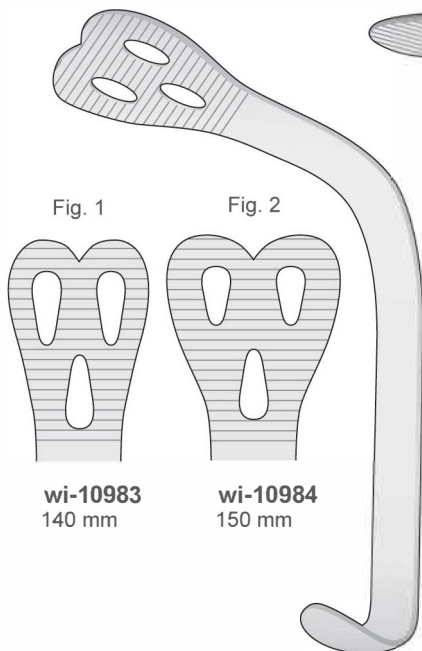
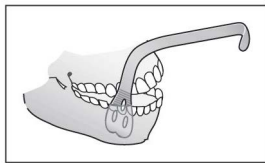

Fig. 1

Fig. 2

wi-10983
140 mm

wi-10984
150 mm

WIEDER
wi-10985

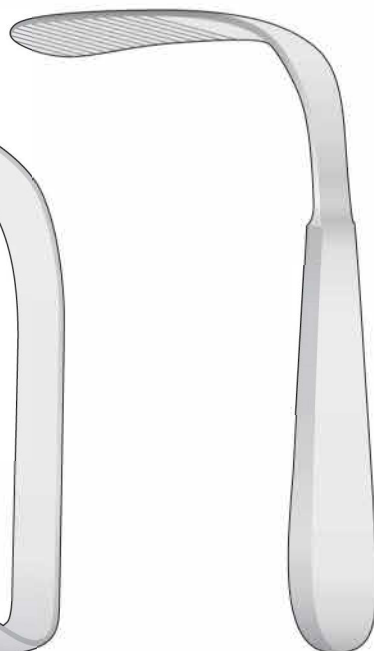

TOBOLD
wi-10986
145 mm

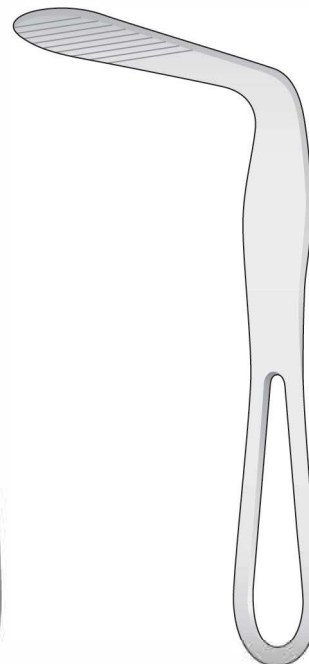

HARTMANN
wi-10987
150 mm

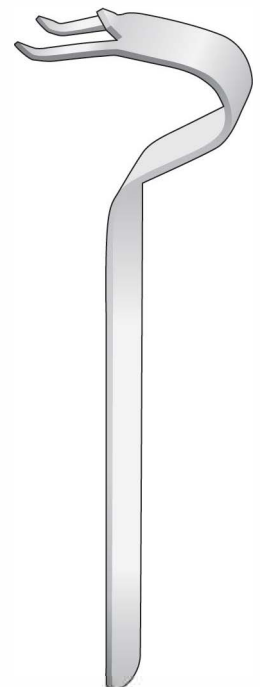

OBWEGESER
wi-10988
155 mm



Wundhaken
Retractors
Divaricatori
Separadores
Écarteurs

Ramushaken für Spina Nasalis
Ramus Retractor for nasal spine
Divaricatori per spina nasalis
Separadores para spina nasalis
Écarteurs pour spina nasalis

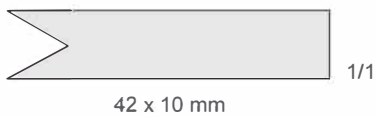

1/1

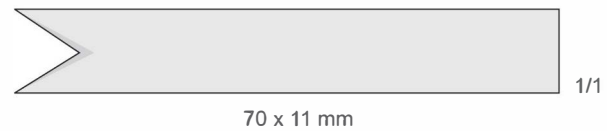

1/1



OBWEGESER
wi-10989
220 mm

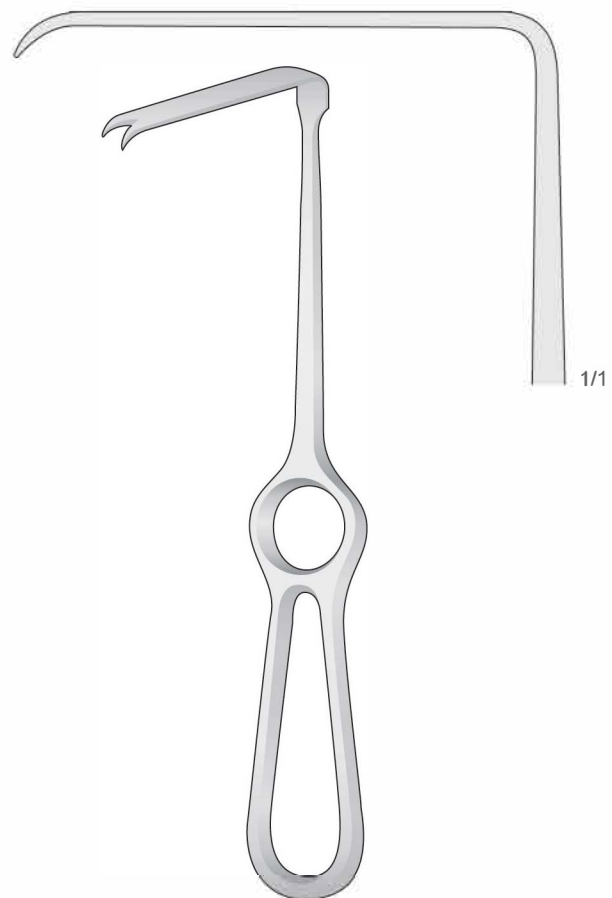

OBWEGESER
wi-10990
220 mm



Mundsperrer
Mouth gags
Apribocca
Abrebocas
Écarteur buccal

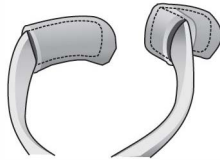

Paar Einsätzen aus Silikon für:
Pair of silicone inserts for: Coppia
di inserti in silicone per: Pareja de
inserto de silicone para: Paire de
inserts en silicón pour:

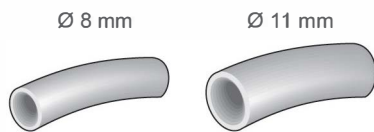

Ø 8 mm

Ø 11 mm

wi-10991
30 mm

wi-10992
30 mm

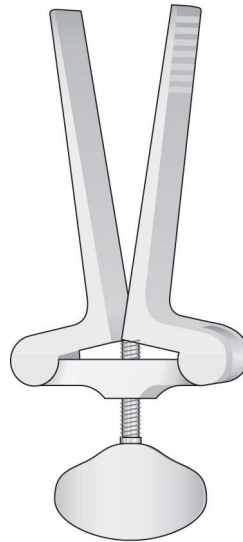

HEISTER
wi-10993
135 mm

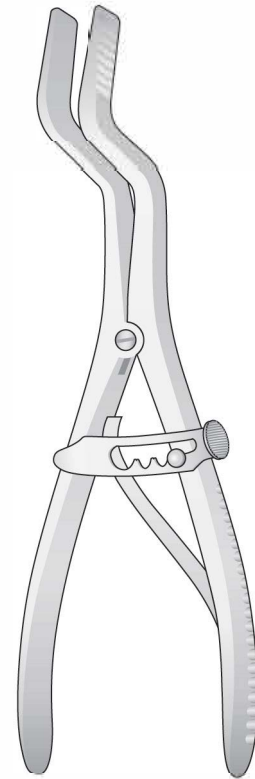

ROSER KÖNIG
wi-109094
185 mm

Für Erwachsene - For adults
Per adulti - Para adultos
Pour adultes

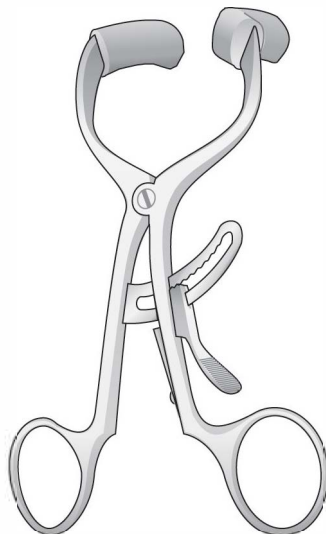

MOLT
DOYEN-JANSEN
wi-10995
140 mm

Für Erwachsene - For adults
Per adulti - Para adultos
Pour adultes

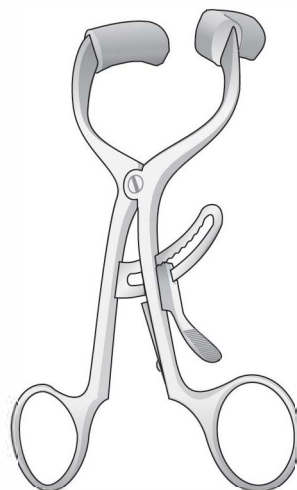

MOLT
DOYEN-COLLIN
wi-1096
120 mm

Für Kinder
For children
Per bambini
Para niños
Pour enfants

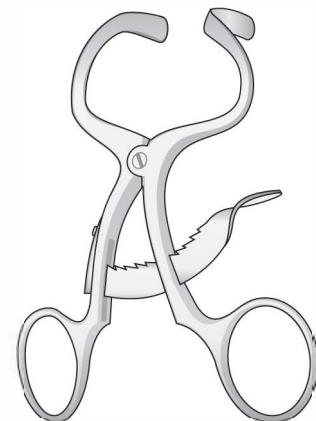

MOLT
wi-10997
100 mm



Mundsperrer
 Mouth gags
 Apribocca
 Abrebocas
 Écarteur buccal

Abhalter für gesamten Ober-bzw. Unterkiefer
 Retractor for complete upper resp. Lower jaws
 Retrattore per arcata superiore e inferiore intera
 Separadores para quijadas enteras inferiores y superiores
 Écarteurs pour machoires complètes inférieures et supérieures

OM-74 Fig. 0 100 x 95 mm

OM-75 Fig. 1 115 x 105 mm

OM-76 Fig. 2 115 x 110 mm

OM-77 Fig. 3 125 x 115 mm

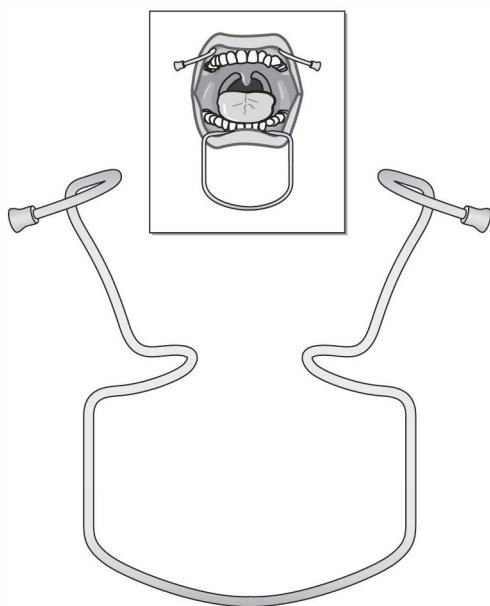

ORINGER
wi-10998

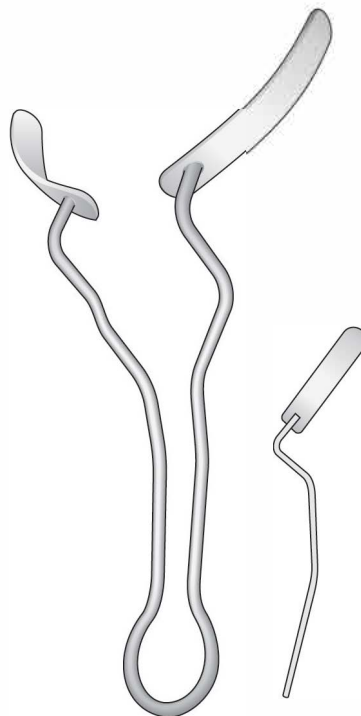

MATY
wi-10999
 170 mm

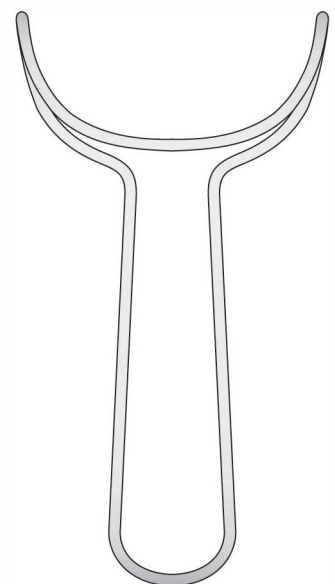

wi-11001
 150 mm



Wundhaken
Retractors
Divaricatori
Separadores
Écarteurs

wi-11006
Set completo
Set complete
Komplettsset
Set complet
Set completo
BT-284 + BT-285 + BT-286

29 mm
26 mm
22 mm

28 mm
38 mm
44 mm

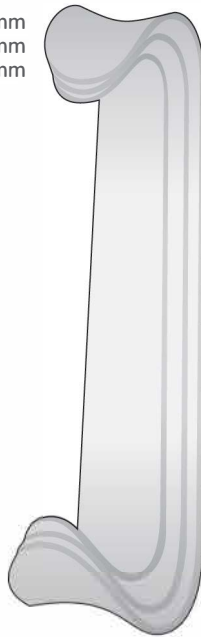

**ROUX
wi-11002**
165 mm

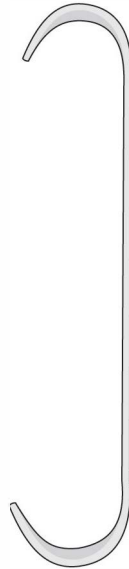

**ROUX
wi-11003**
20x22 mm
25x28 mm

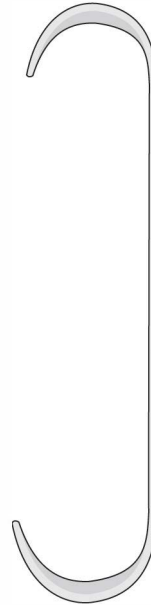

**ROUX
wi-11004**
23x26 mm
29x38 mm

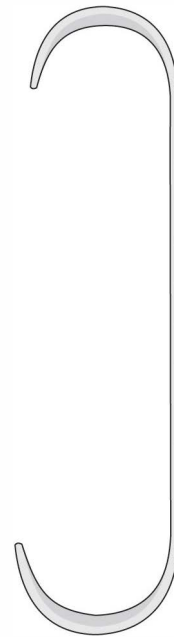

**ROUX
wi-11005**
29x29 mm
34x44 mm

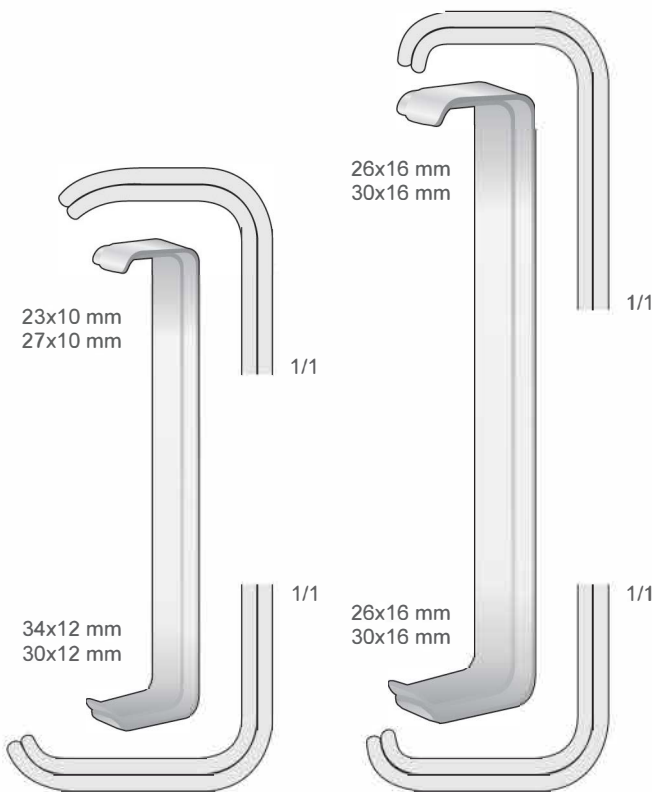

23x10 mm
27x10 mm

26x16 mm
30x16 mm

20x22 mm

23x26 mm

29x29 mm

34x12 mm
30x12 mm

26x16 mm
30x16 mm

25x28 mm

29x38 mm

34x44 mm

**FARABEUF
wi-11007**
120 mm

**FARABEUF
wi-11008**
150 mm

**ROUX-MAGNUS
wi-11009**
150 mm

**ROUX-MAGNUS
wi-11010**
160 mm

**ROUX-MAGNUS
wi-11011**
170 mm



Wundhaken
Retractors
Divaricatori
Separadores
Écarteurs

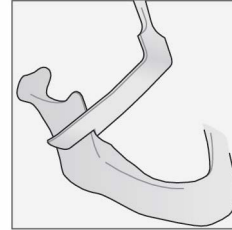

Ramus Retraktoren Recht
Ramus Retractor Right
Retrattore Ramus destro
Separadores Ramus derecho
Écarteur Ramus droites

Ramus Retraktoren Link
Ramus Retractor Left
Retrattore Ramus sinistro
Separadores Ramus izquierdo
Écarteur Ramus gauches

8 mm

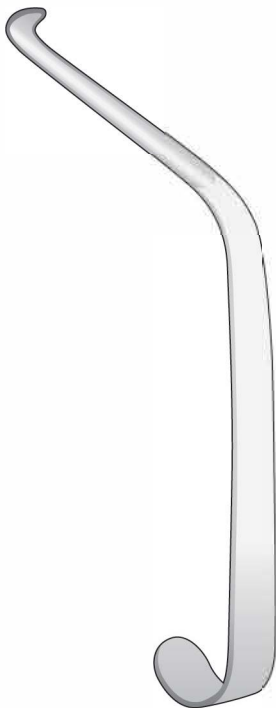

OBWEGESER
wi-11012
165 mm

10 mm

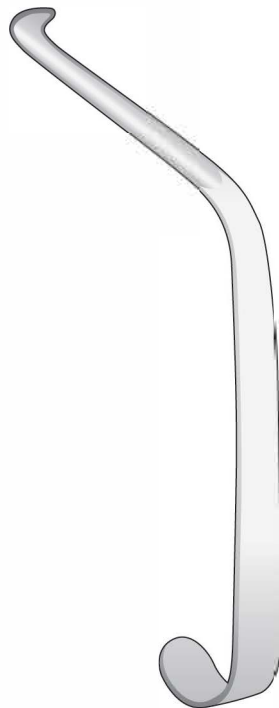

OBWEGESER
wi-11013
165 mm



MISCH
wi-11014
210 mm



MISCH
wi-11015
210 mm



Mundsperrer
Mouth Gags
Apribocca
Abrebocas
Écarteur buccal

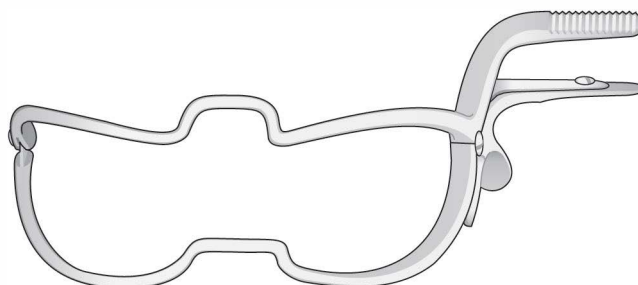

WHITEHEAD-JENNINGS
wi-11016 90 mm **wi-11017**
110 mm **wi-11018** 130 mm
wi-11019 150 mm

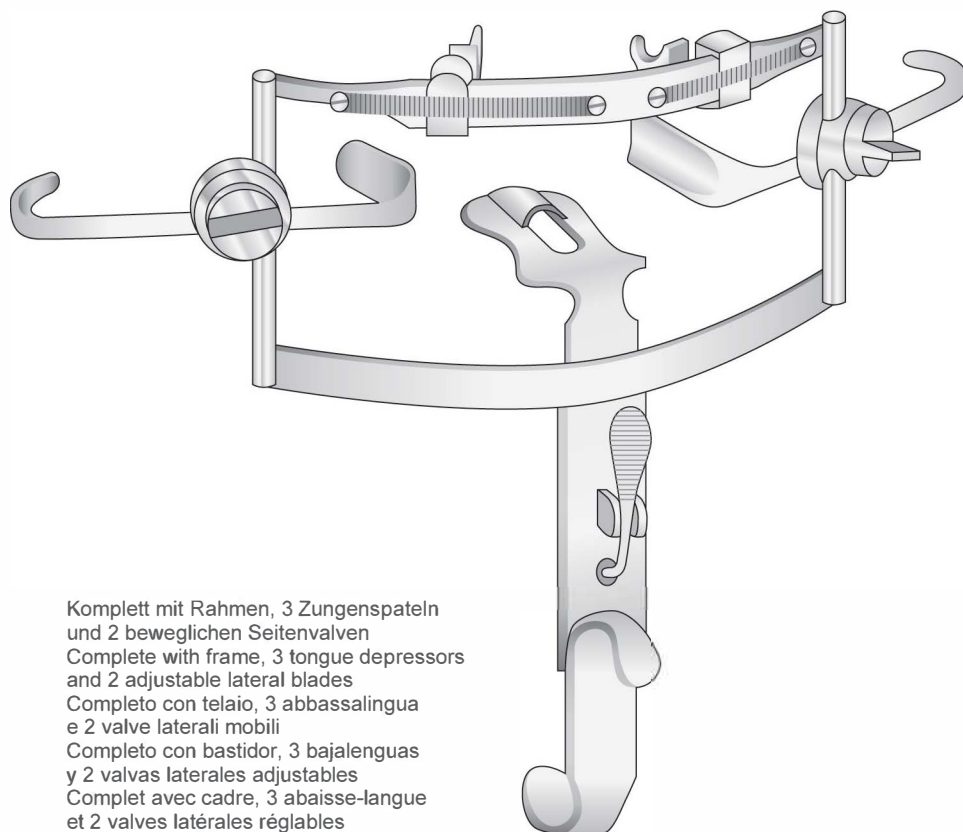

Komplett mit Rahmen, 3 Zungenspateln
und 2 beweglichen Seitenvälven
Complete with frame, 3 tongue depressors
and 2 adjustable lateral blades
Completo con telaio, 3 abbassalingua
e 2 valve laterali mobili
Completo con bastidor, 3 bajalenguas
y 2 valvas laterales ajustables
Complet avec cadre, 3 abaisse-langue
et 2 valves latérales réglables

DINGMANN
wi-11023
Set completo

DINGMANN

Zungenspatel
Tongue depressor
Abbassalingua
Bajalengua
Abaisse langue

Fig. 1

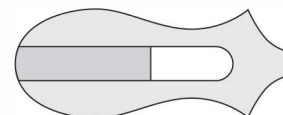

wi-11020
65 x 25 mm

Fig. 2

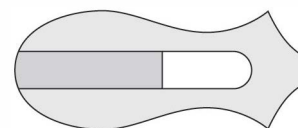

wi-11021
70 x 29 mm

Fig. 3

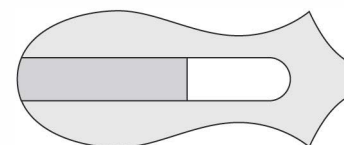

wi-11022
80 x 32 mm



Wundhaken
Retractors
Divaricatori
Separadores
Écarteurs

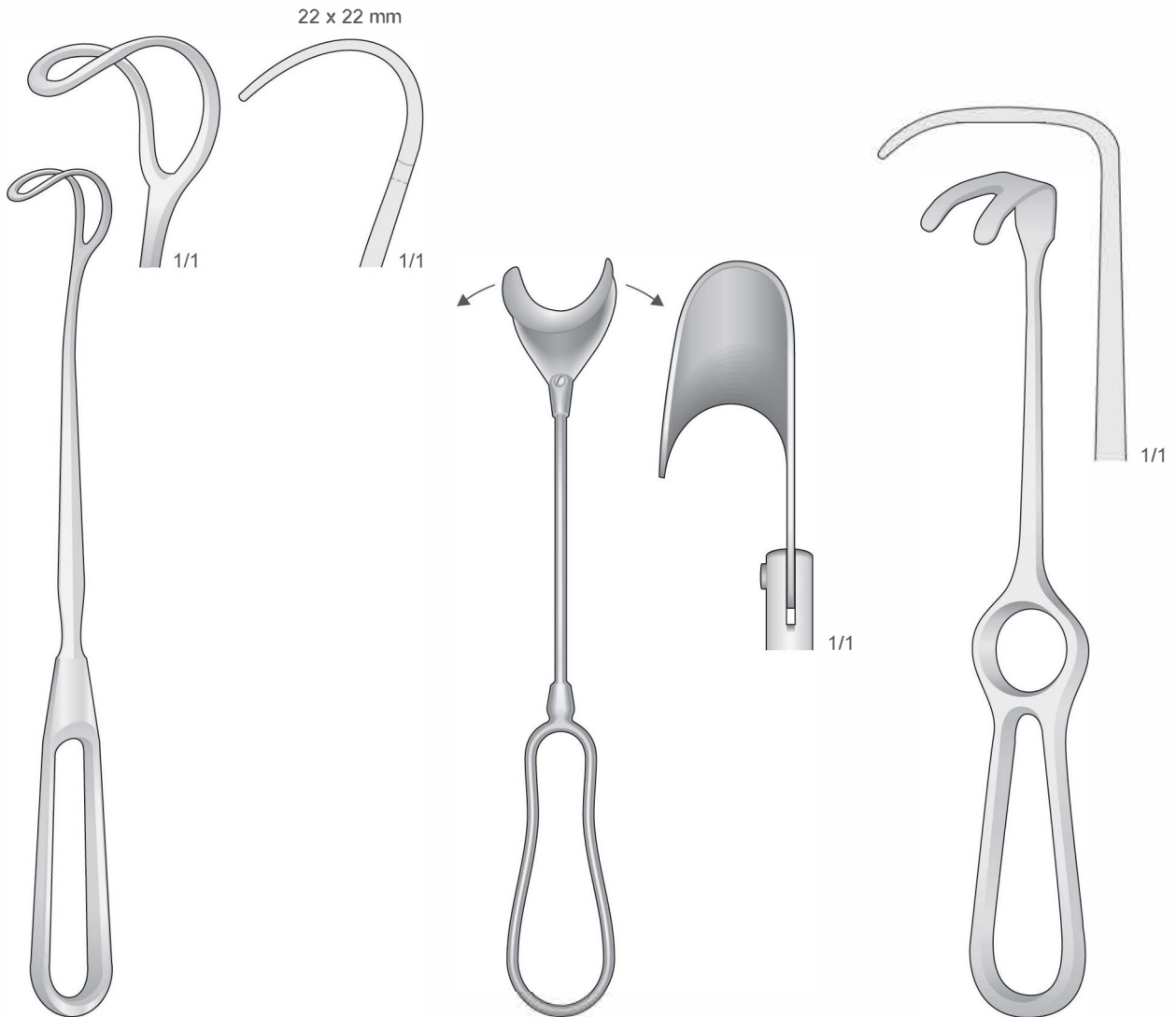

GREENE
wi-11024
225 mm

wi-11025
200 mm

WASSMUND
wi-11026
220 mm



Zungenspatel - Zungenzangen
 Tongue Depressors - Tongue Holding Forceps
 Abbassalingua - Pinze tiralingua
 Bajalenguas - Pinzas tira-lengua
 Abaisse langues - Pinces tire-langue

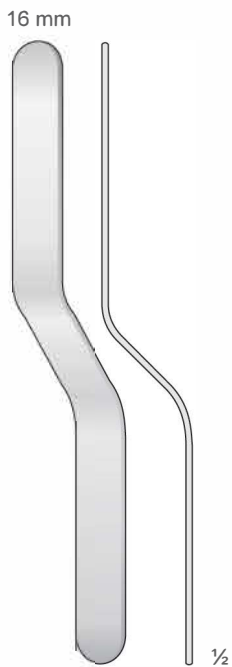

wi-11027
145 mm

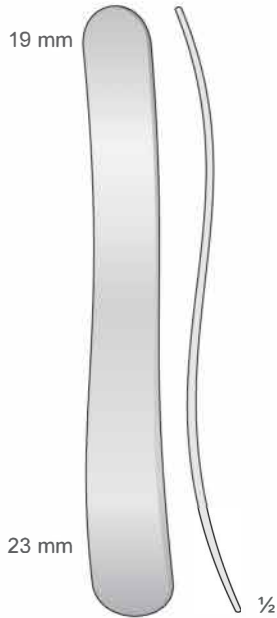

KROENIG
wi-11028
150 mm

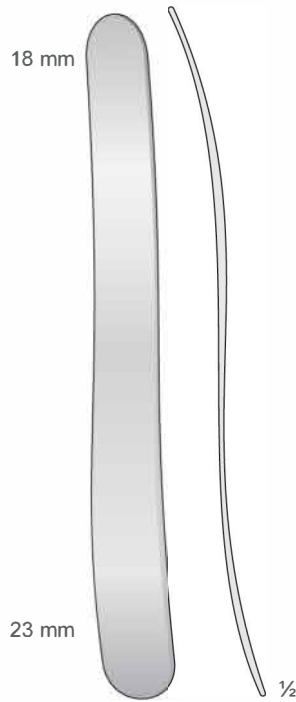

BUCHWALD
wi-11029
180 mm

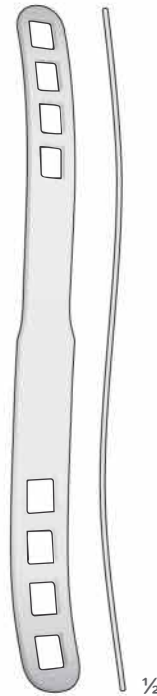

BRUENINGS
wi-11030
190 mm

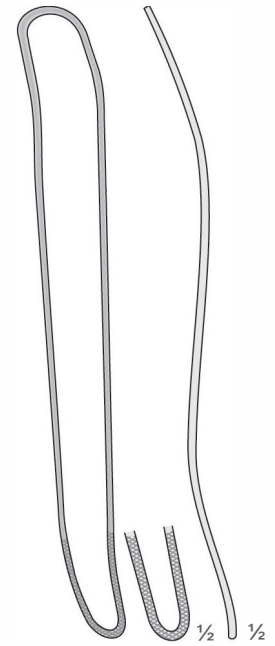

FRENZEL
wi-11031
165 mm

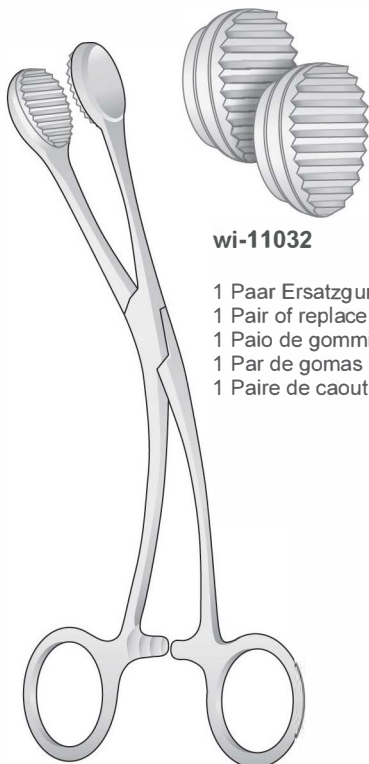

YOUNG
wi-11035
160 mm

wi-11032

- 1 Paar Ersatzgummi
- 1 Pair of replacement rubber pads
- 1 Paio de gommini di ricambio
- 1 Par de gomas de recambio
- 1 Paire de caoutchouc de rechange

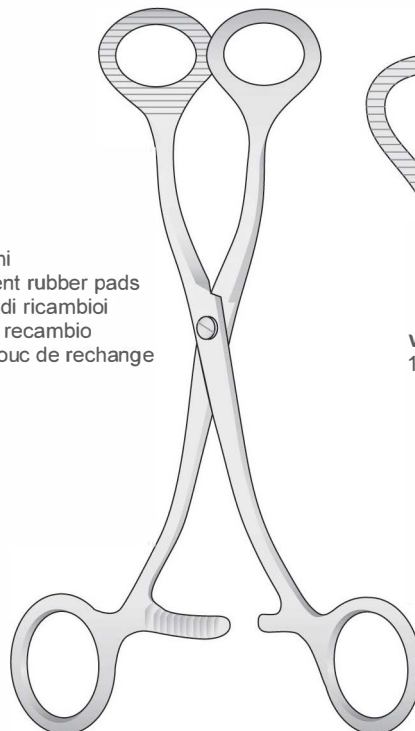

COLLIN
wi-11036

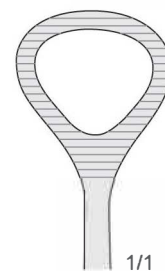

wi-11033
165 mm

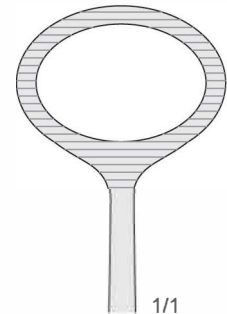

wi-11034
170 mm



Osteotome - Meißel
 Osteotomes - Gouges
 Osteotomi - Sgorbie
 Osteótomos - Gubias
 Ostéotomes - Gouges

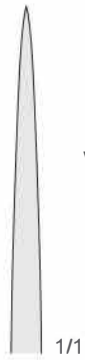

wi-11037
6 mm



8 mm



wi-11038
10 mm

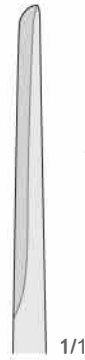

wi-11039
6 mm



8 mm



wi-11040
10 mm

wi-11041
140 mm

wi-11042
140 mm

9 mm



Flexible
Flessibile

wi-11043
170 mm

3 mm

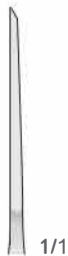

wi-11044
155 mm

6 mm



wi-11045
155 mm

9 mm



wi-11046
155 mm

Fig. 55

Fig. 75



KRAMER-NEVINS
wi-11047
175 mm

6 mm



wi-11048
180 mm



Osteotome - Hohlmeissel
 Osteotomes - Gouges
 Osteotomi - Scalpelli
 Osteótomos - Cinceles
 Osteótomes - Scalpel

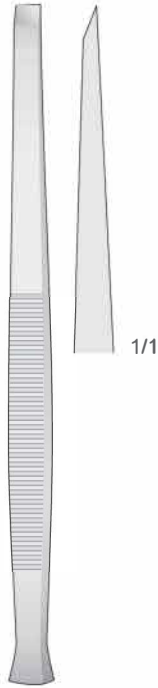

PARTSCH
wi-11055
 140 mm



wi-11049
 3 mm

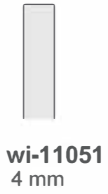

wi-11051
 4 mm



wi-11053
 5 mm

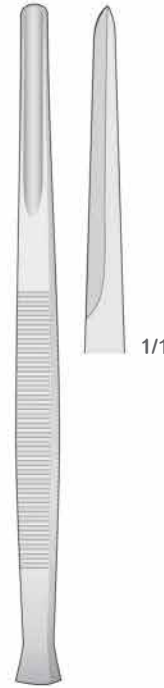

PARTSCH
wi-11056
 140 mm



wi-11050
 3 mm

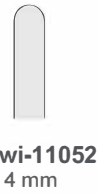

wi-11052
 4 mm



wi-11054
 5 mm

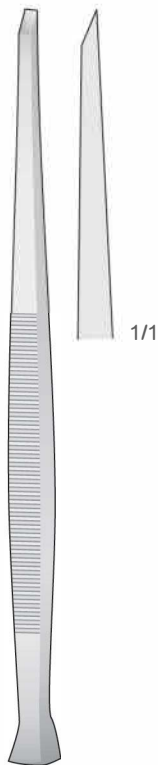

PARTSCH
wi-11067
 170 mm



wi-11057
 3 mm



wi-11058
 6 mm

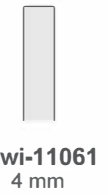

wi-11061
 4 mm



wi-11062
 7 mm

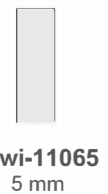

wi-11065
 5 mm

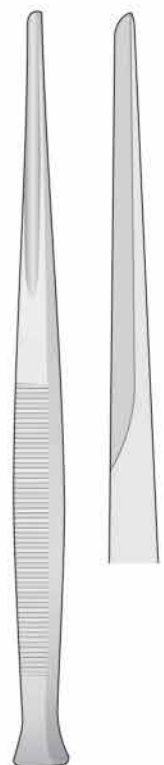

PARTSCH
wi-11068
 170 mm



wi-11059
 3 mm



wi-11060
 6 mm



wi-11063
 4 mm



wi-11064
 7 mm



wi-11066
 5 mm



Osteotome - Meissel
 Osteotomes - Chisels
 Osteotomi - Scalpelli
 Osteótomos - Cinceles
 Ostéotomes - Burins

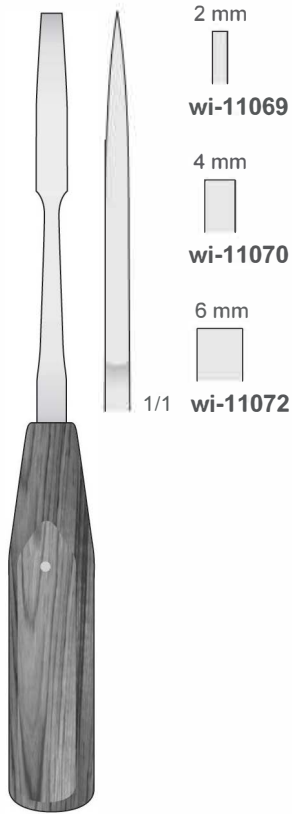

MINI-LEXER
wi-11074
 200 mm

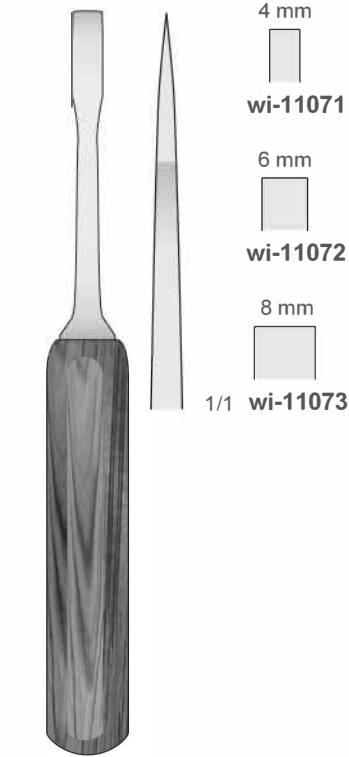

MINI-LEXER
wi-110754
 180 mm

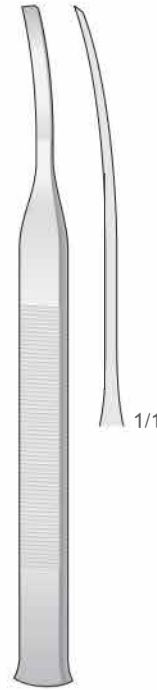

TESSIER
 wi-11076
 wi-11077
 160 mm



TESSIER
wi-11078
 160 mm

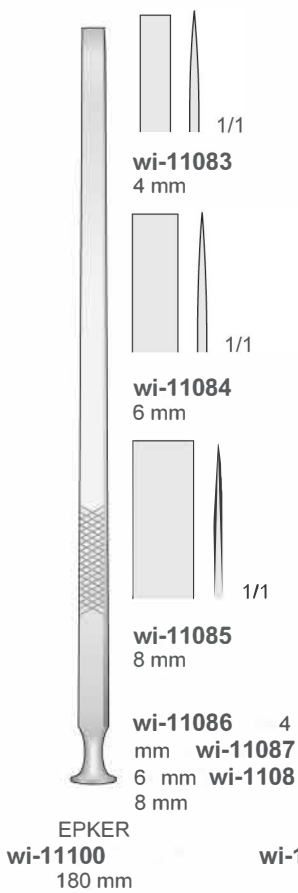
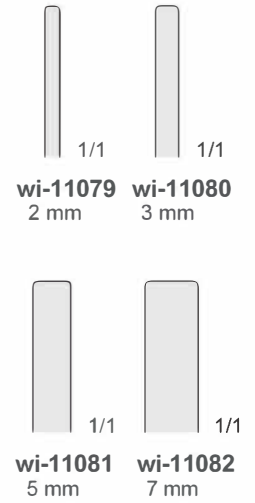

EPKER
wi-11100
 180 mm

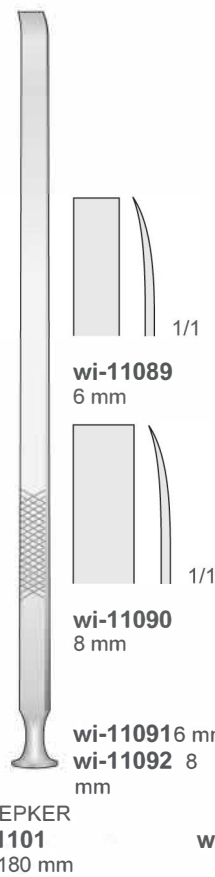

EPKER
wi-11101
 180 mm

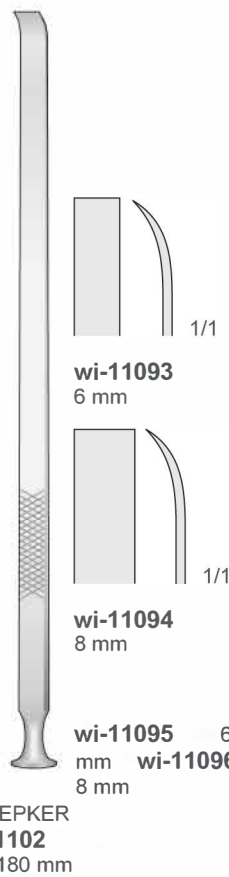

EPKER
wi-11102
 180 mm

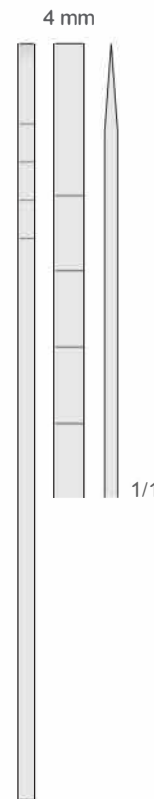

COTTLE
wi-11097
 180 mm

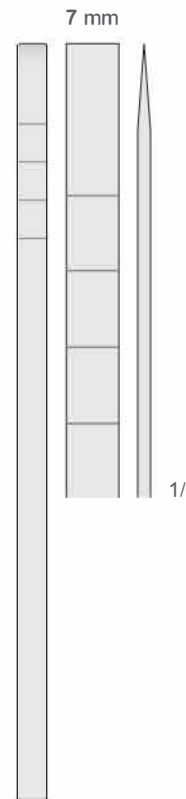

COTTLE
wi-11098
 180 mm

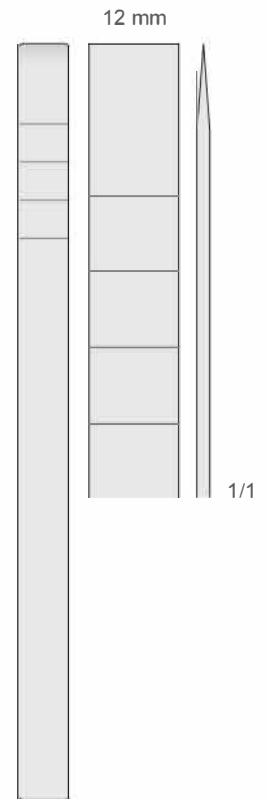

COTTLE
wi-11099
 180 mm



Osteotome
Osteotomes
Osteotomi
Osteótomos
Ostéotomes

# 1	Diam.	# 2	Diam.	# 3	Diam.	# 4	Diam.	# 5	Diam.
0	Ø 1.50	0	Ø 2.10	0	Ø 2.60	0	Ø 3.00	0	Ø 3.50
5	Ø 1.90	5	Ø 2.60	5	Ø 3.00	5	Ø 3.50	5	Ø 3.90
8	Ø 2.20	8	Ø 2.80	8	Ø 3.30	8	Ø 3.80	8	Ø 4.20
10	Ø 2.40	10	Ø 3.00	10	Ø 3.50	10	Ø 4.00	10	Ø 4.40
12	Ø 2.60	12	Ø 3.20	12	Ø 3.70	12	Ø 4.20	12	Ø 4.60
14	Ø 2.80	14	Ø 3.40	14	Ø 3.90	14	Ø 4.40	14	Ø 4.80

Straight
Gerade
Droit
Recto
Diritto

Bone Pusher

1
Ø 1.5 mm



wi-11103
55 mm

2
Ø 2.1 mm



wi-11104
155 mm

3
Ø 2.6 mm



wi-11105
155 mm

4
Ø 3.0 mm



wi-11106
155 mm

5
Ø 3.5 mm



wi-11107
155 mm

Ø 2.8 mm



wi-11108
155 mm

Ø 3.5 mm



wi-11109
155 mm

Ø 4.2 mm



wi-11110
155 mm



Osteotome
Osteotomes
Osteotomi
Osteótomos
Ostéotomes

Meißeln Graduiert
Graduated Chisels
Scalpelli graduati
Cinceles graduados
Burins gradués

<p>3.8 mm</p>	<p>3.8 mm</p>	<p>7.5 mm</p>	<p>7.5 mm</p>
<p>wi-11111 170 mm</p>	<p>wi-11112 170 mm</p>	<p>wi-11113 170 mm</p>	<p>wi-11114 170 mm</p>



Osteotome

Osteotomes
Osteotomi
Osteótomos
Ostéotomes

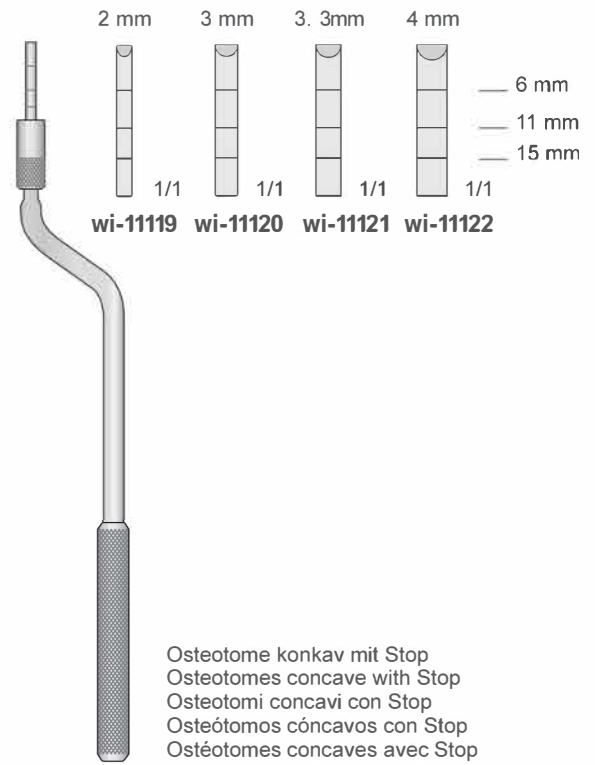
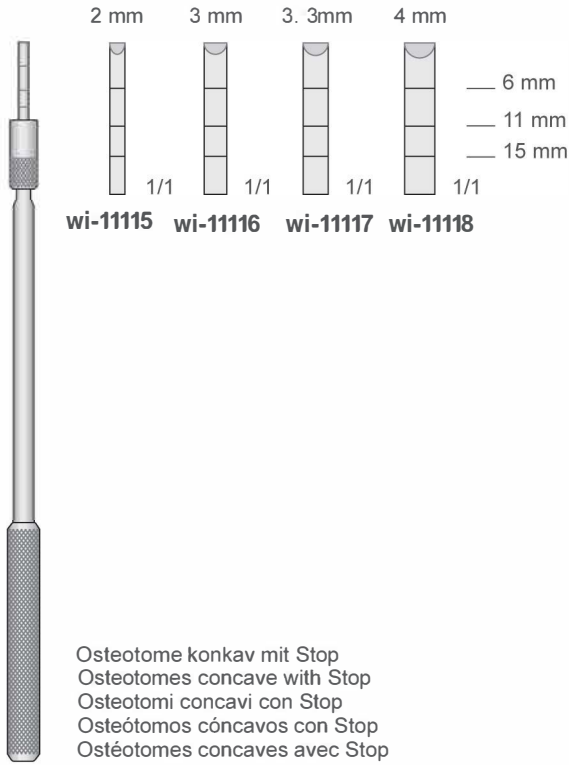

wi-11123
165 mm

wi-11124
165 mm

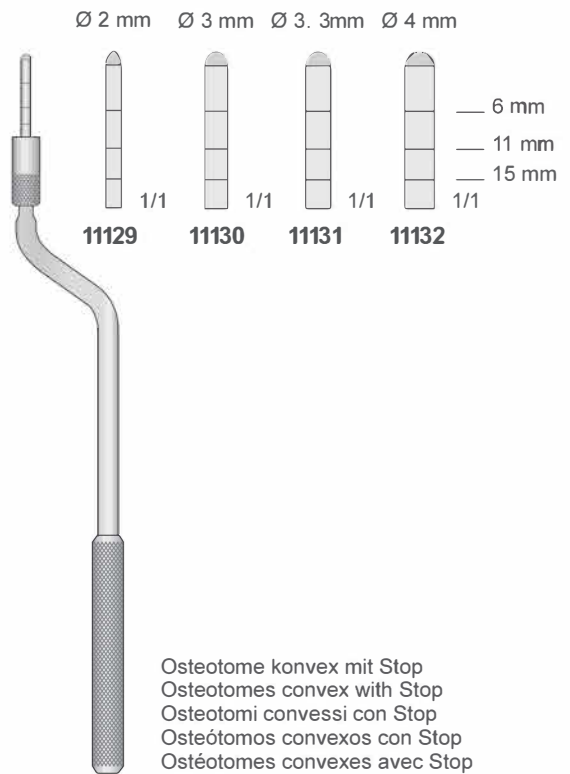
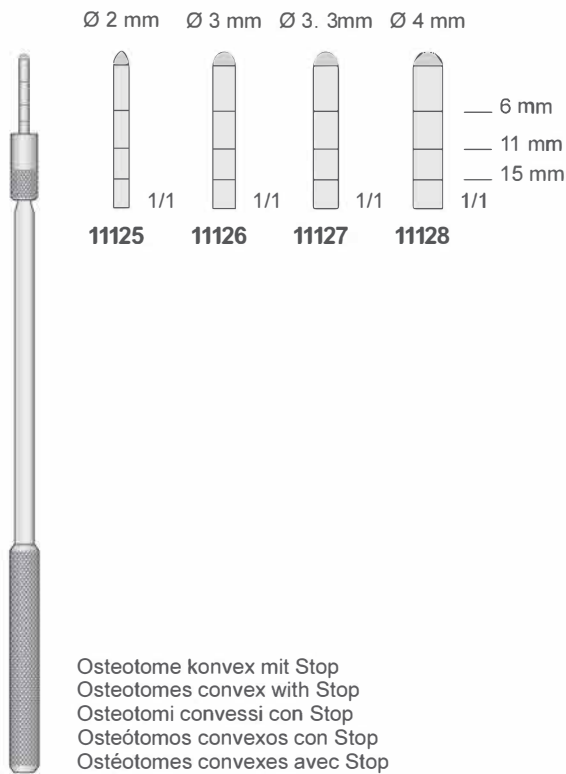

wi-11133
165 mm

wi-11134
160 mm



Osteotome
Osteotomes
Osteotomi
Osteótomos
Ostéotomes



Dilatator
Dilator
Dilatatori
Dilatador
Dilatateur

A-Form

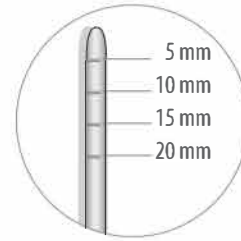

Spreader
Spreader
Expansori
Expansor
Expandeur

**D-Form
Convex Tip**

Ø 2 mm



wi-11135
145 mm

Ø 3 mm



wi-11136
145 mm

Ø 3.3 mm



wi-11137
145 mm

Ø 4 mm



wi-11138
145 mm

Ø 3 mm



wi-11139
145 mm

Ø 4 mm



wi-11140
145 mm

Ø 5 mm



wi-11141
145 mm



Raspatorien - Elevatorien
 Raspatories - Elevators
 Periostotomi - Elevatori
 Legras - Elevadores
 Rugines - Elevateurs

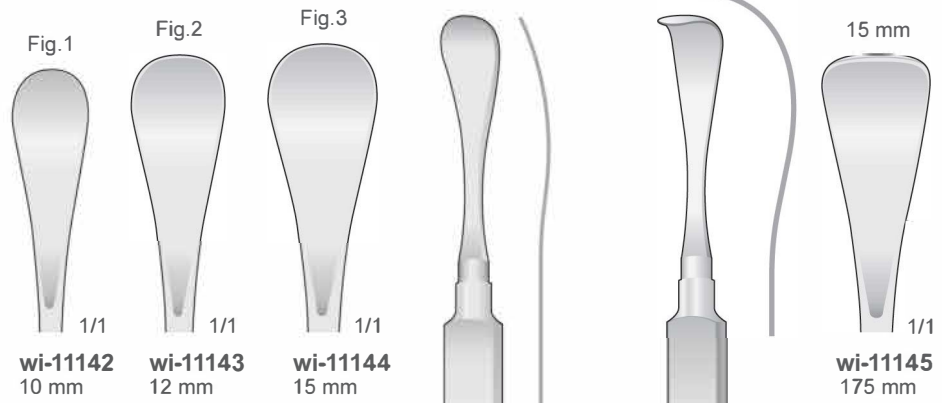

Halbscharf
 Semi-Scharp
 Semitagliente
 Semicortante
 Semitranchant

HENAHAN
wi-11146
 175 mm

HENAHAN
wi-11147
 175 mm

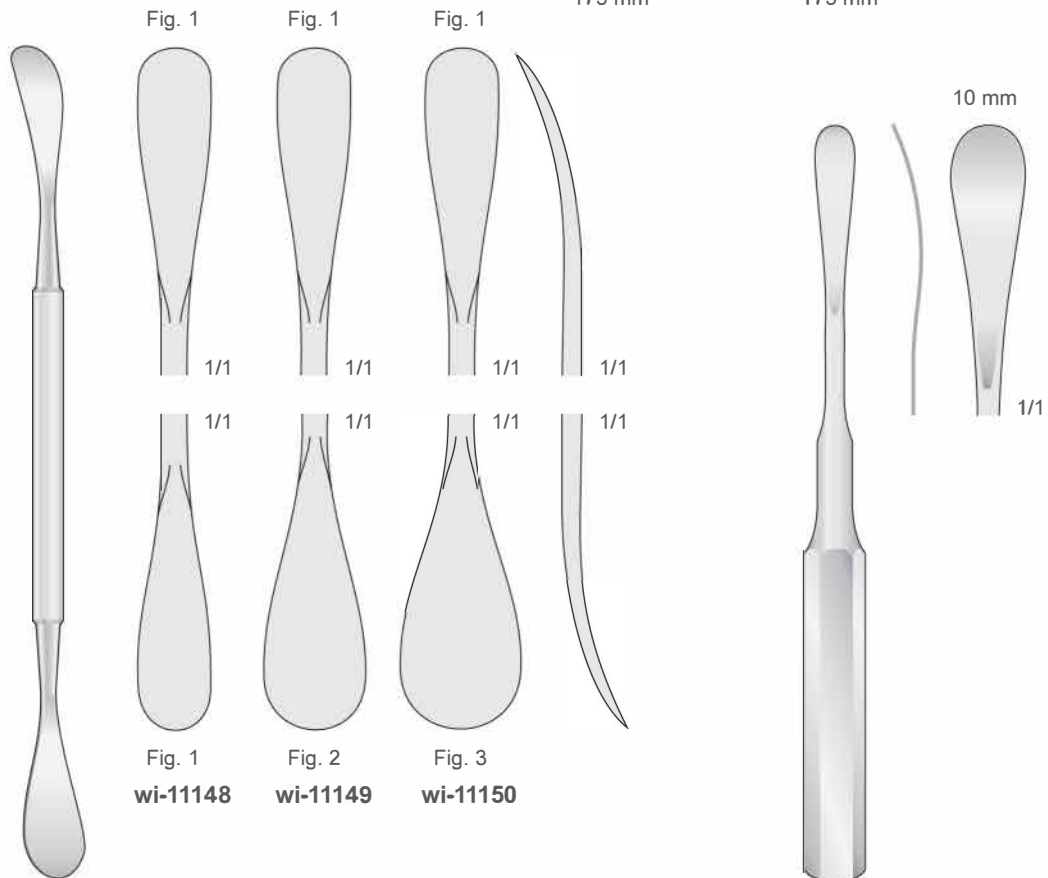

HENAHAN
wi-11151
 200 mm

MOLT
wi-11152
 160 mm



Raspatorien - Elevatorien
 Raspatories - Elevators
 Periostotomi - Elevatori
 Legras - Elevadores
 Rugines - Elevateurs

Fig. 12S

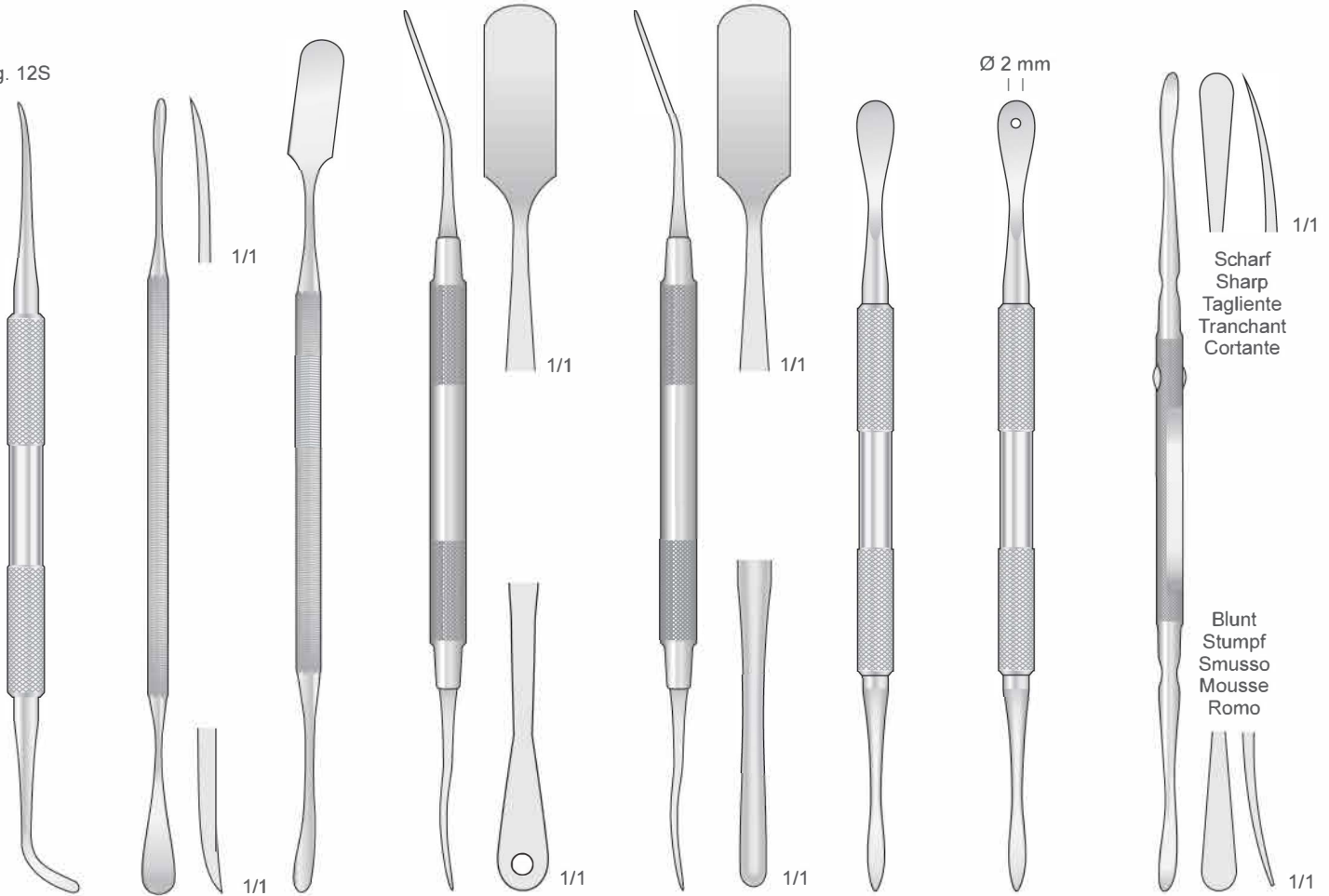

BENNETT
wi-11153
 175 mm

wi-11154
 175 mm

wi-11155
 190 mm

PRICHARD
wi-11156
 180 mm

PRICHARD
wi-11157
 175 mm

MOLT
wi-11158
 170 mm

MOLT
wi-11159
 170 mm

wi-11160
 180 mm

Ø 2 mm
 ||
 ||

Scharf
 Sharp
 Tagliente
 Tranchant
 Cortante

Blunt
 Stumpf
 Smusso
 Mousse
 Romo



Raspatorien - Elevatorien
 Raspatories - Elevators
 Periostotomi - Elevatori
 Legras - Elevadores
 Rugines - Elevateurs

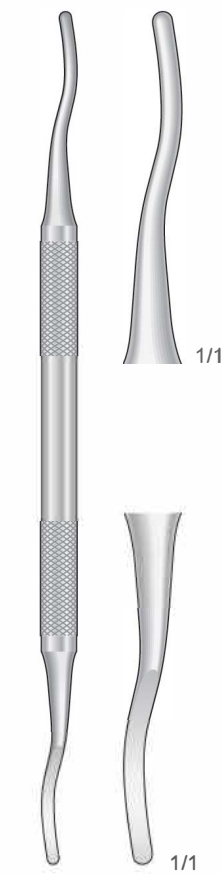

HOPKINS
wi-11161
 185 mm

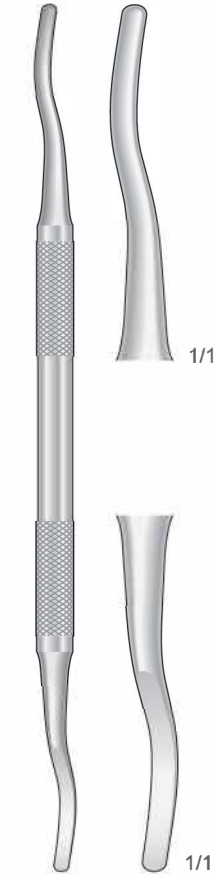

HOPKINS
wi-11162
 185 mm



MEAD
wi-11163
 185 mm

Instrumente für Sinuslift / Sinus Lift Instruments / Strumenti per rialzo del seno
 Instrumentos para elevación de seno maxilar / Instruments d'élévation sinusienne

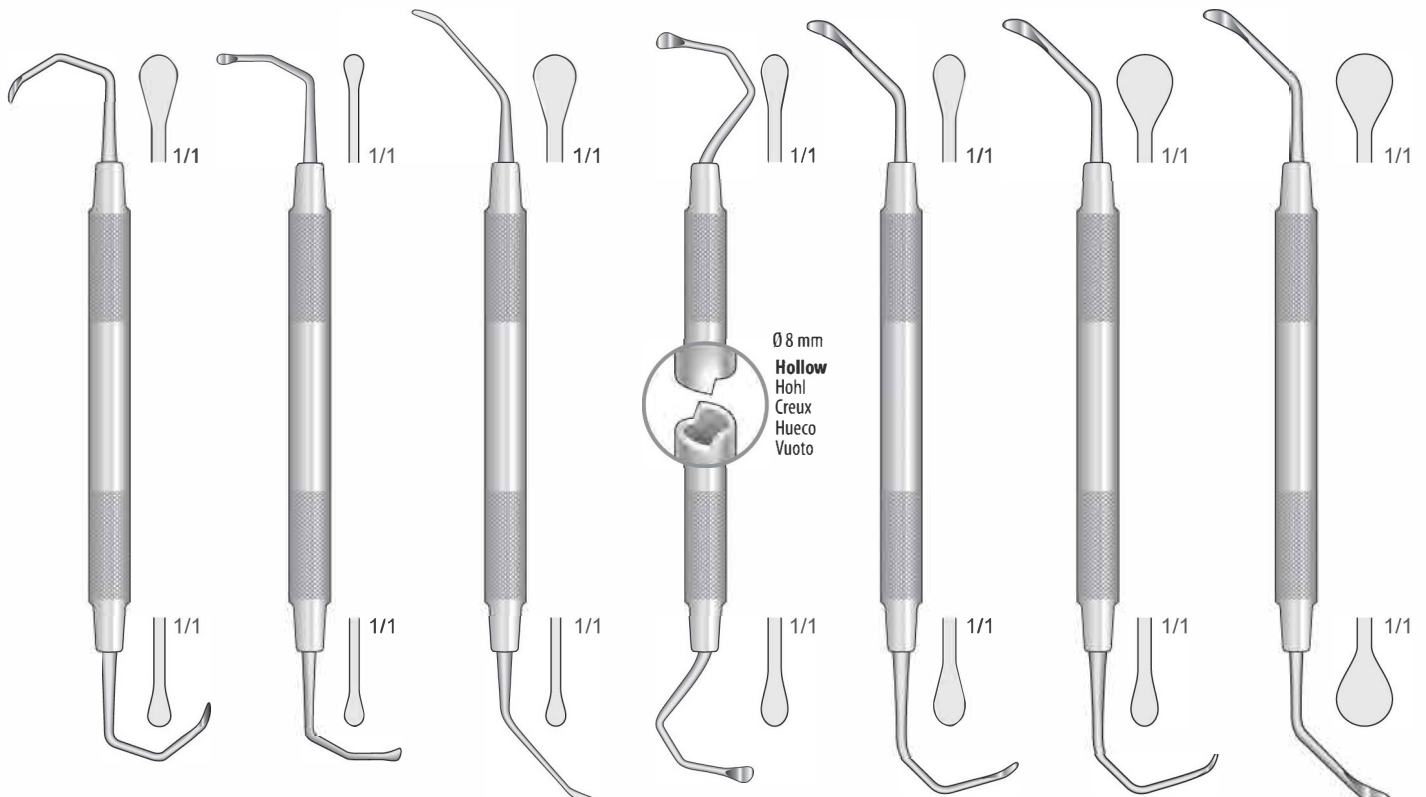

Ø 8 mm
Hollow
 Hohl
 Creux
 Hueco
 Vuoto

wi-11164
 160 mm

wi-11165
 160 mm

wi-11166
 180 mm

wi-11166
 170 mm

wi-11167
 175 mm

wi-11168
 175 mm

wi-11168
 180 mm



Raspatorien - Elevatorien
 Raspatories - Elevators
 Periostotomi - Elevatori
 Legras - Elevadores
 Rugines - Elevateurs

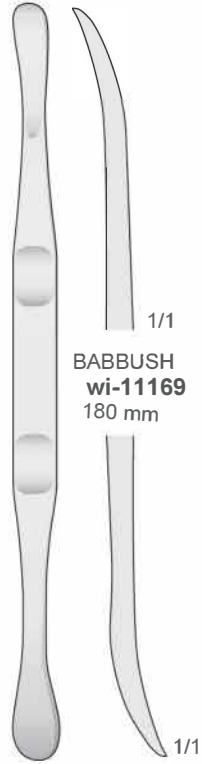

BABBUSH
wi-11169
 180 mm

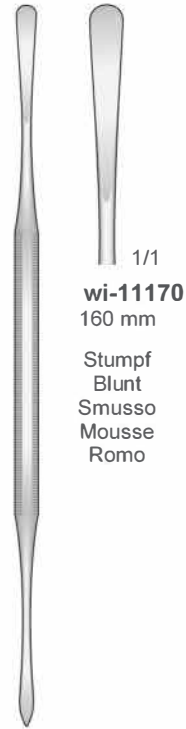

1/1
wi-11170
 160 mm
 Stumpf
 Blunt
 Smusso
 Mousse
 Romo

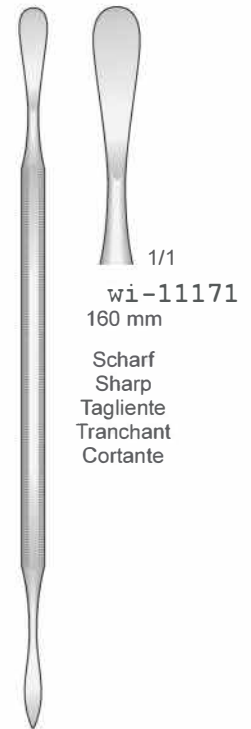

1/1
wi-11171
 160 mm
 Scharf
 Sharp
 Tagliente
 Tranchant
 Cortante

Instrumente für Sinuslift
 Sinus Lift Instruments

Strumenti per rialzo del seno
 Instrumentos para elevación de seno maxilar
 Instruments d'élevation sinusienne

Fig. 24G



MOLT
wi-11172
 180 mm



wi-11173
 175 mm



WOODSON
wi-11174
 170 mm

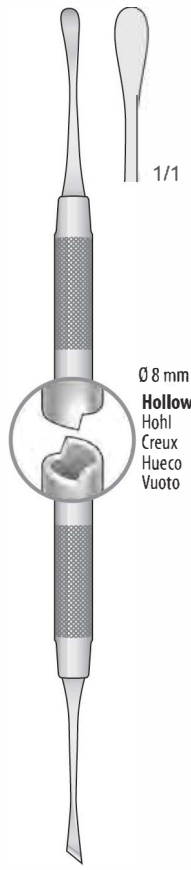

wi-11175
 175 mm

Ø 8 mm
 Hollow
 Hohl
 Creux
 Hueco
 Vuoto



wi-11176
 175 mm



wi-11177
 165 mm



wi-11178
 170 mm



Raspatorien - Elevatorien
 Raspatories - Elevators
 Periostotomi - Elevatori
 Legras - Elevadores
 Rugines - Elevateurs

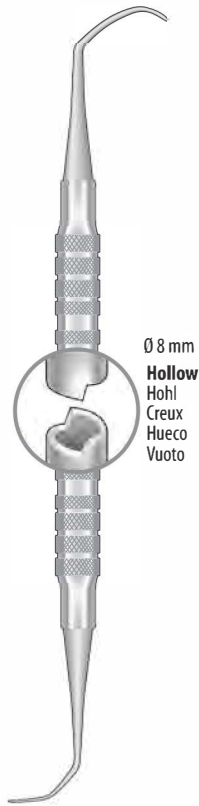

Ø 8 mm
Hollow
 Hohli
 Creux
 Hueco
 Vuoto

wi-11179

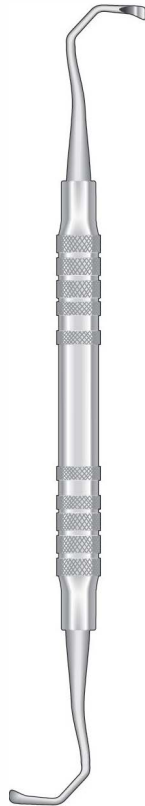

wi-11180



wi-11181



wi-11182



wi-11183



wi-11184



wi-11185



Ø 8 mm
Hollow
 Hohli
 Creux
 Hueco
 Vuoto

wi-11186



Küretten
Curettes
Curettes
Curetas
Curettes

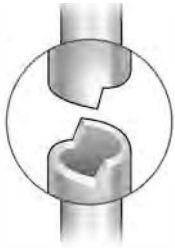

Runder Hohlgriff 8 mm
Hollow Round Handle 8 mm
Manico tondo vuoto 8 mm
Mango hueco 8 mm
Manche rond vide 8 mm



HEMINGWAY
wi-11195
180 mm

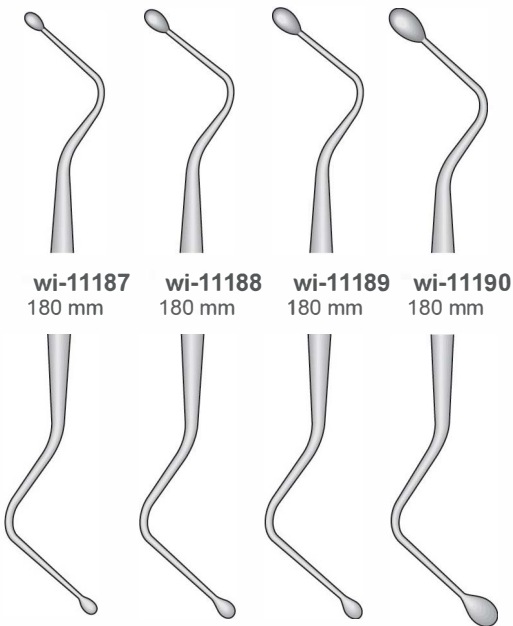

wi-11187 180 mm
wi-11188 180 mm
wi-11189 180 mm
wi-11190 180 mm

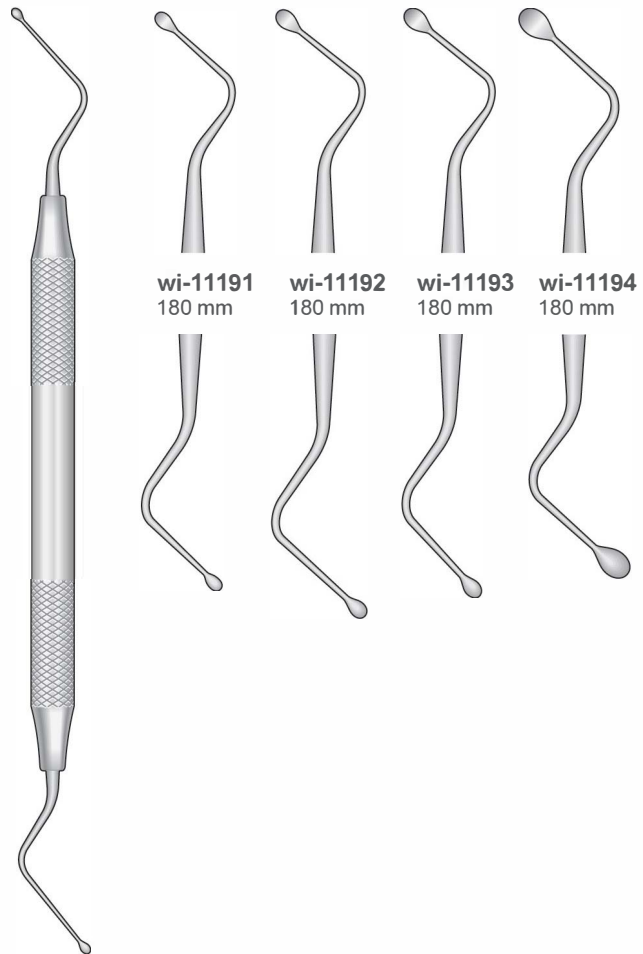

LUCAS
wi-11196
180 mm



Küretten
Curettes
Curettes
Curetas
Curettes

Wundhachen Mandibular
Mandibular Nerve Diplace
Per spostamento
nervo mandibolare
Para nero mandibular



HEMINGWAY
wi-11197
170 mm



HEMINGWAY
wi-11198
170 mm

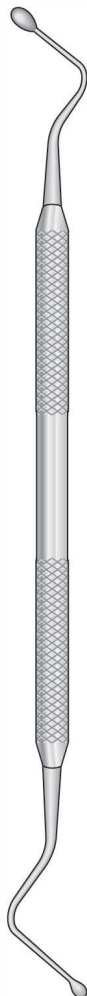

HEMINGWAY
11199
170 mm

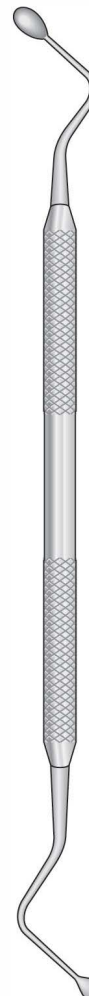

HEMINGWAY
wi-11200
170 mm



wi-11201
165 mm



Küretten
Curettes
Curettes
Curetas
Curettes

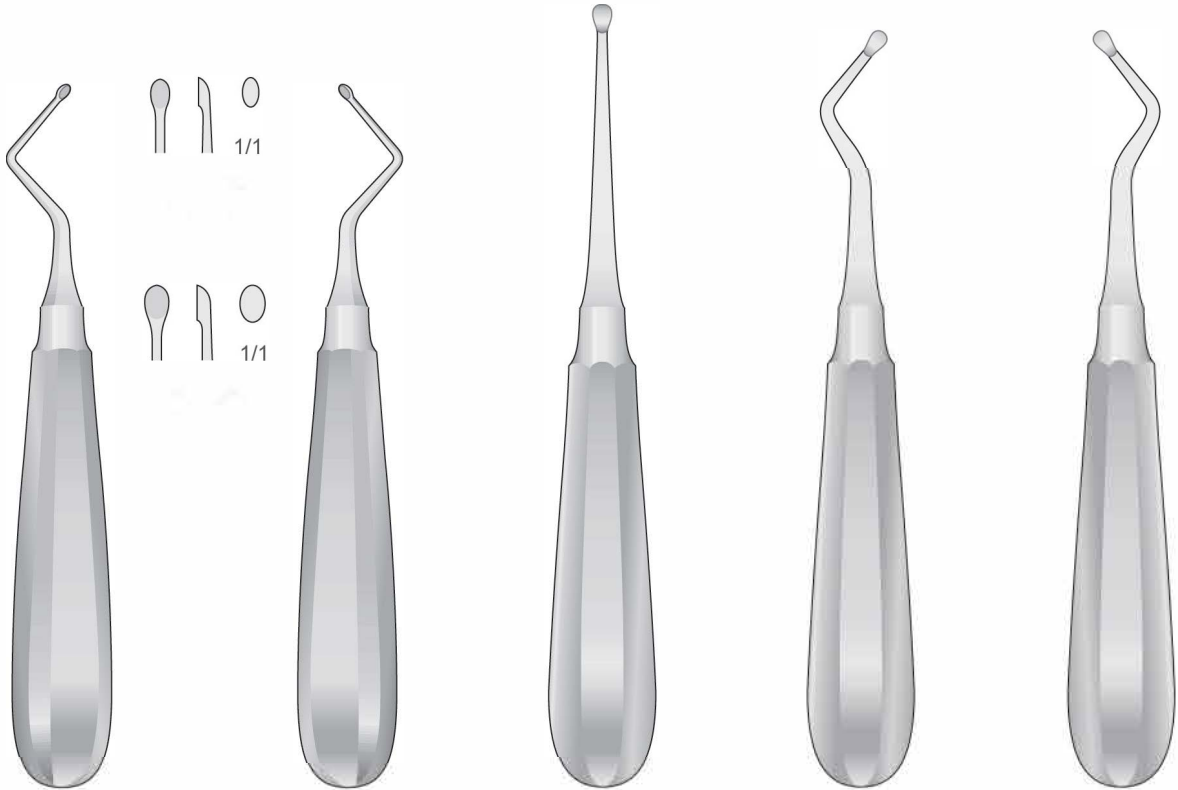

**KERPEL
wi-11202**
145 mm

**KERPEL
wi-11204**
145 mm

wi-11206
155 mm

wi-11207
150 mm

wi-11208
150 mm

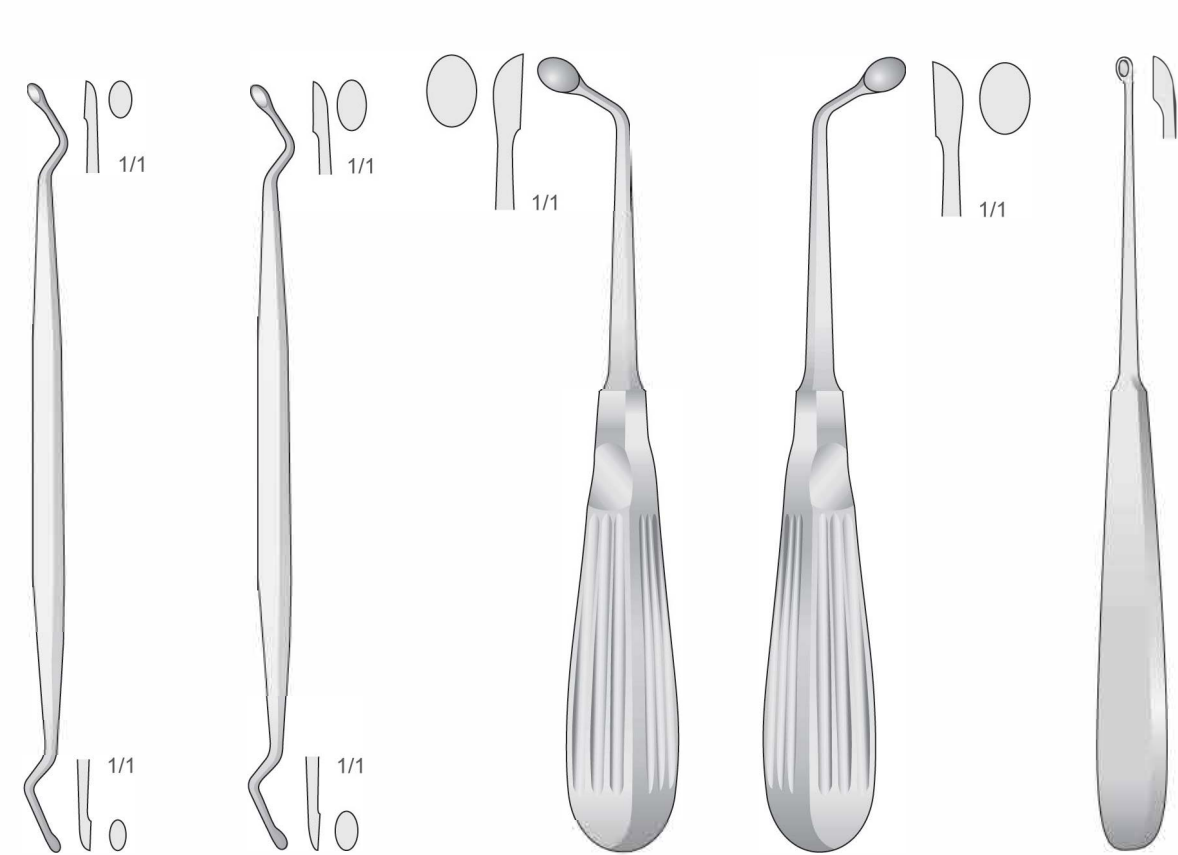

wi-11211
160 mm

**JANSEN
wi-11212**
160 mm

**UFFENORDE
wi-11213**
170 mm

**UFFENORDE
wi-11214**
170 mm

**WILLIGER
wi-11215**
170 mm

**Fig. 00
3,4 mm**



wi-11209

**Fig. 1
5,2 mm**

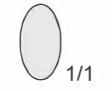

wi-11210



Gewebezängchen
Tissue Nippers
Tronchesi per gengive e tessuti
Pinzas para cortar tejidos
Pinces coupante pour tissue

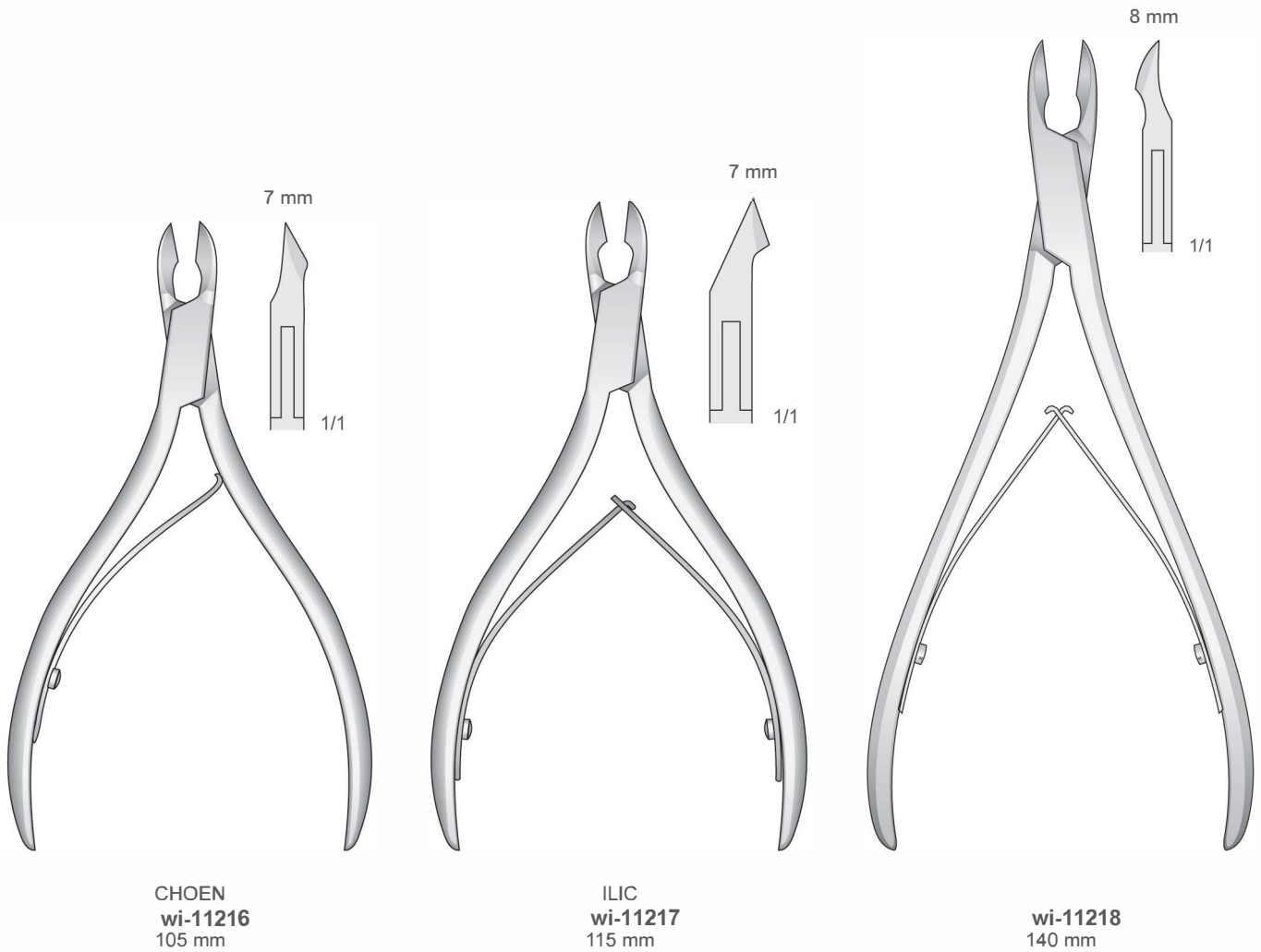



Hohlmeißelzangen
 Bone rongeurs
 Pinze ossivore
 Pinzas gubias
 Pincas gouges

S-Form

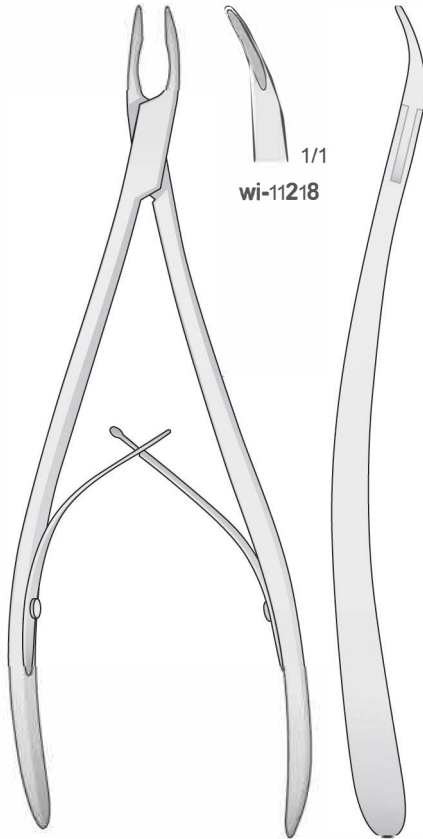

wi-11218



11219

11220

STELLBRINK
wi-11221
 190 mm

STELLBRINK
wi-11222
 170 mm

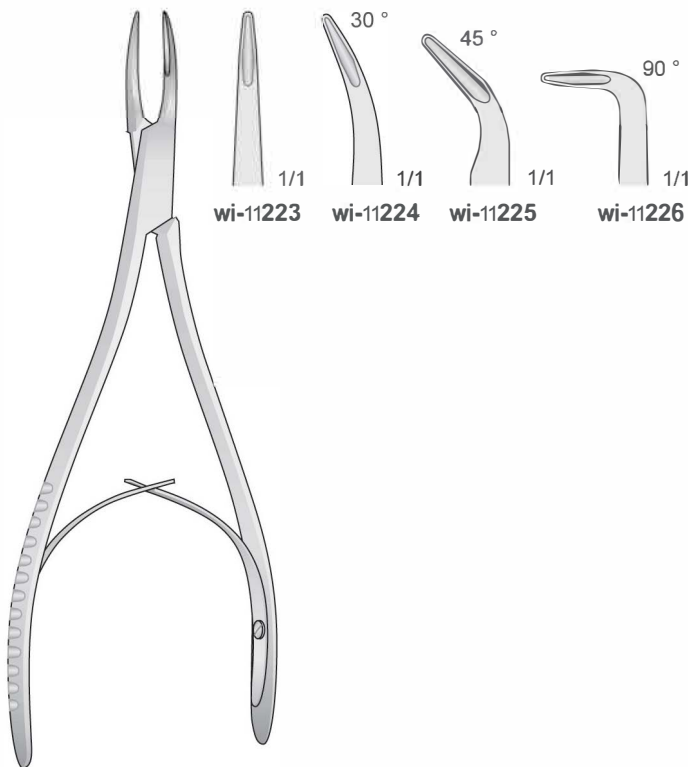

wi-11223

wi-11224

wi-11225

wi-11226

MINI-FRIEDMANN
wi-11228
 150 mm

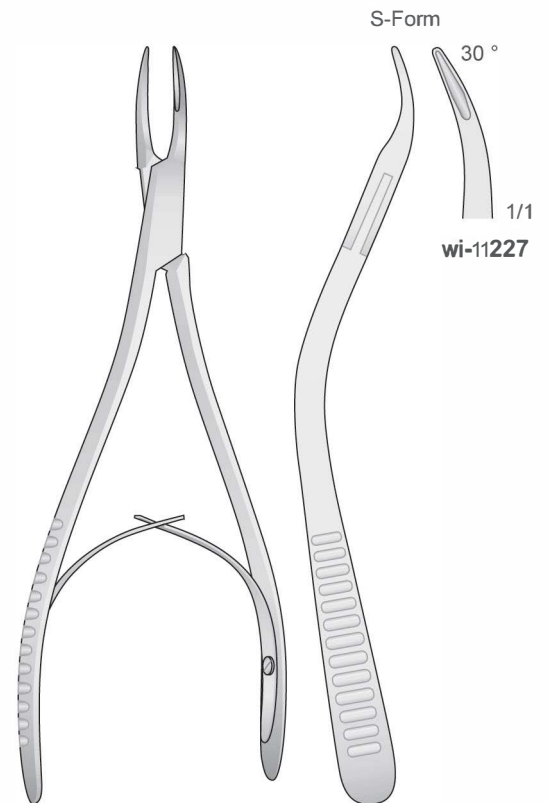

S-Form

wi-11227

MINI-FRIEDMANN
wi-11229
 145 mm



Hohlmeißelzangen
 Bone rongeurs
 Pinze ossivore
 Pinzas gubias
 Pincas gouges

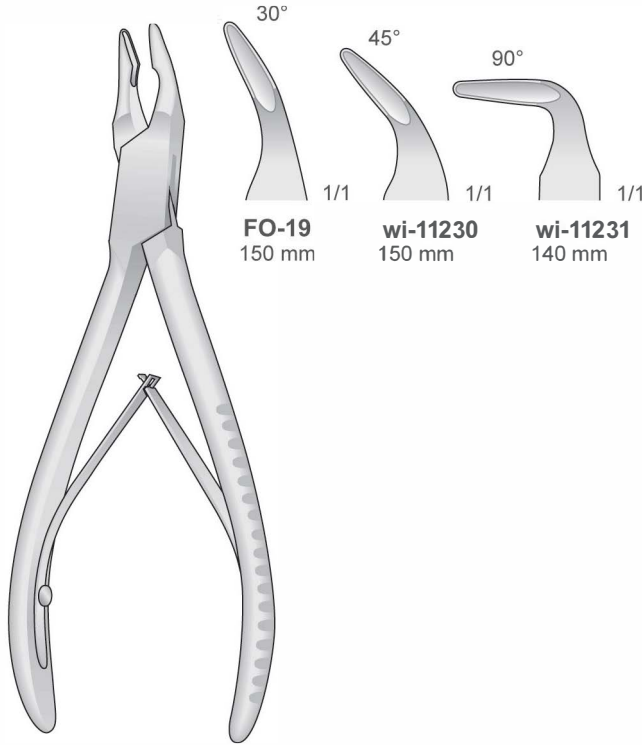

FO-19
150 mm

wi-11230
150 mm

wi-11231
140 mm

BLUMENTHAL
wi-11232

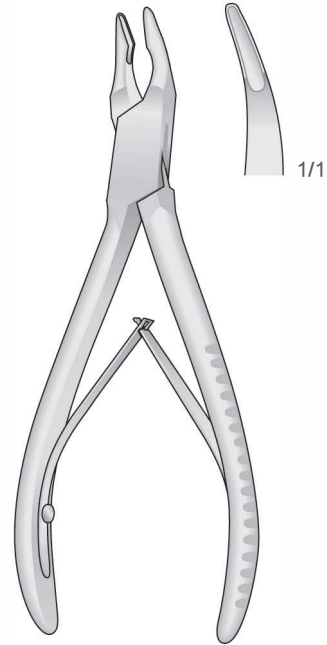

MINI FRIEDMAN
wi-11233
120 mm

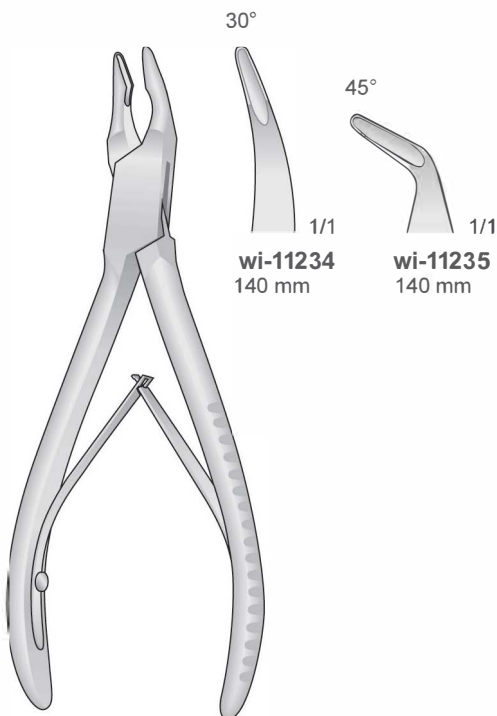

wi-11234
140 mm

wi-11235
140 mm

FRIEDMANN
wi-11237
140 mm

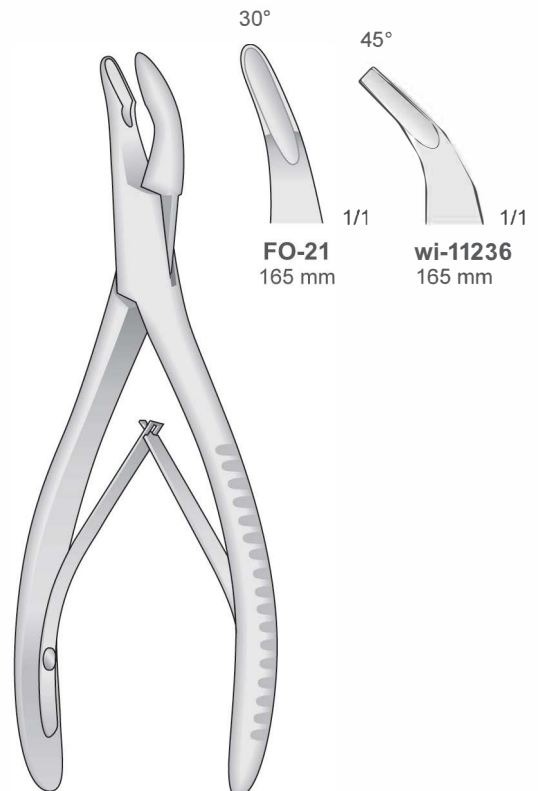

FO-21
165 mm

wi-11236
165 mm

MEAD
wi-11238
165 mm



Hohlmeißelzangen
 Bone rongeurs
 Pinze ossivore
 Pinzas gubias
 Pincas gouges

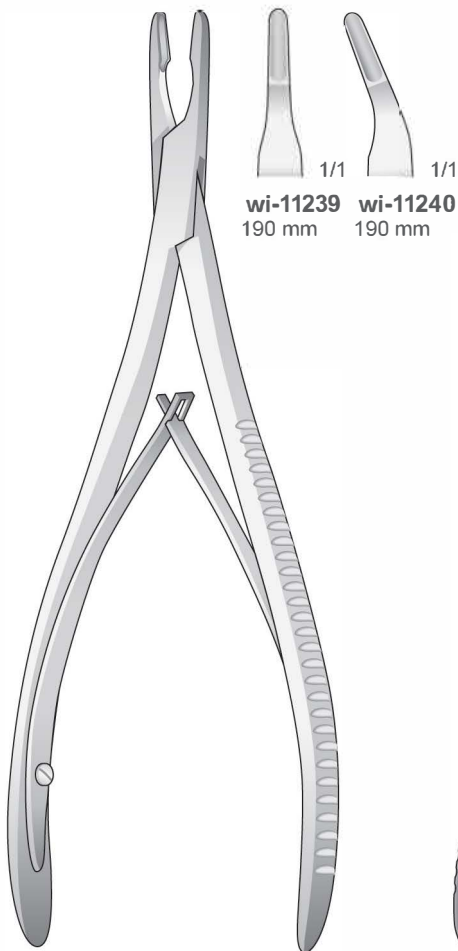

wi-11239 190 mm
wi-11240 190 mm

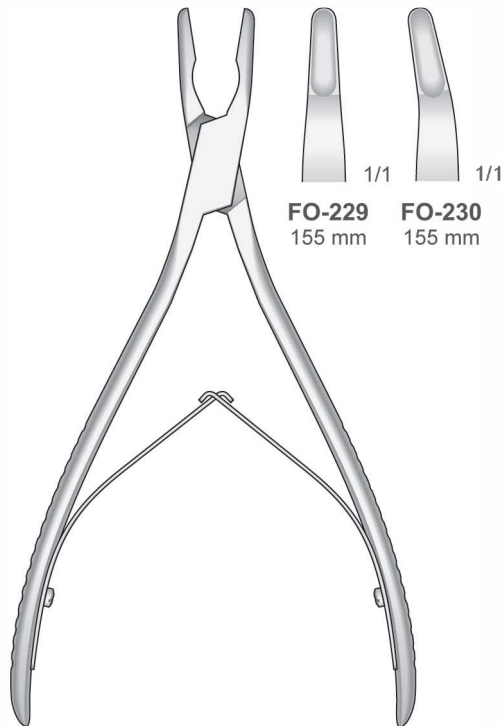

FO-229 155 mm
FO-230 155 mm

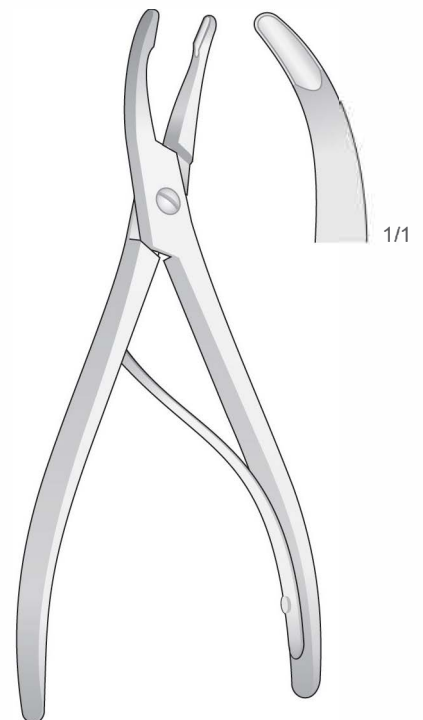

LUER
wi-11243
 155 mm



Hand Instruments

Hohlmeißelzangen
Bone rongeurs
Pinze ossivore
Pinzas gubias
Pincas gougues

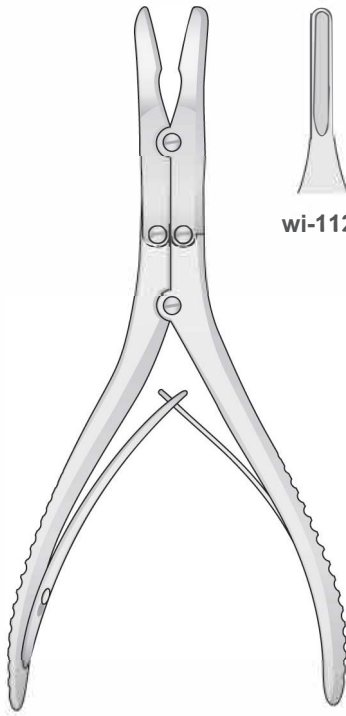

RUSKIN
wi-11285
150 mm

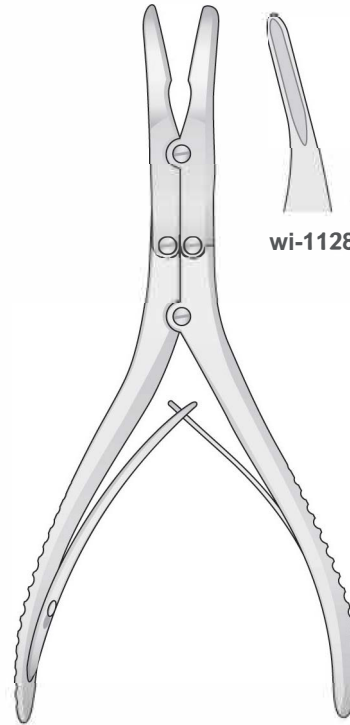
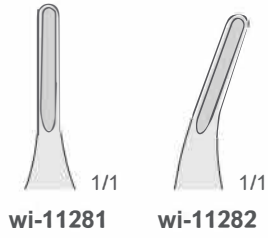

KLEINERT-KUTZ
wi-11286
155 mm

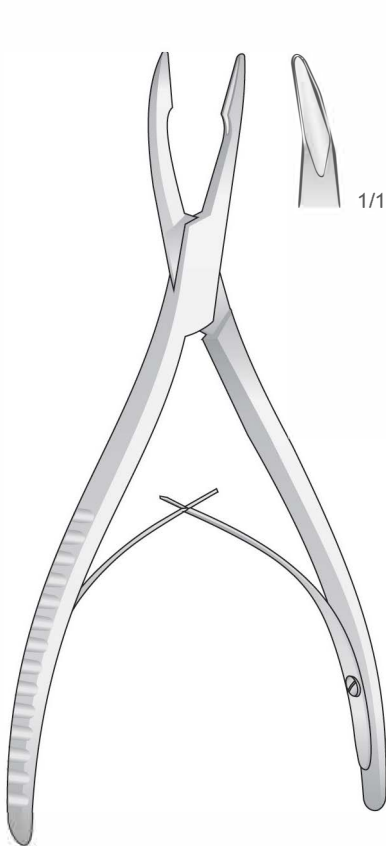
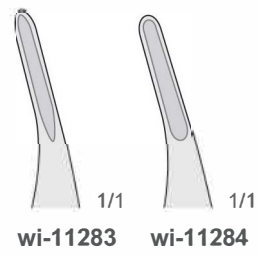

FRIEDMANN
wi-11287
160 mm



BEYER
wi-11288
180 mm

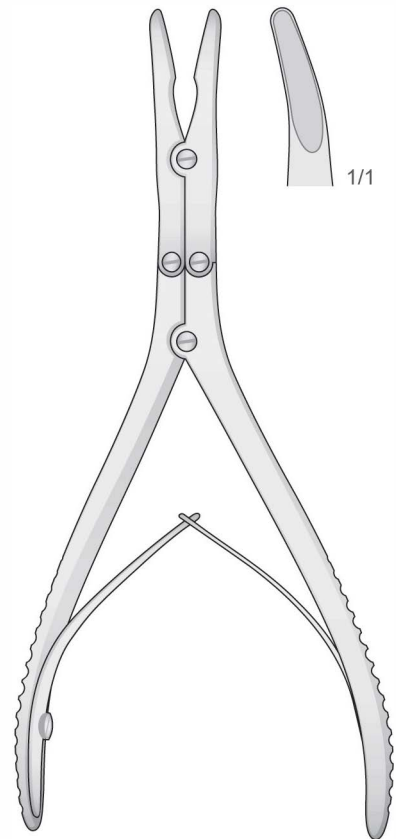
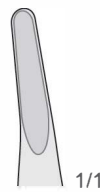

ZAUFAL-JANSEN
wi-11289
180 mm

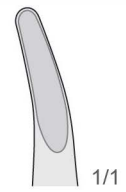



Hohlmeißelzangen
 Bone rongeurs
 Pinze ossivore
 Pinzas gubias
 Pincas gouges

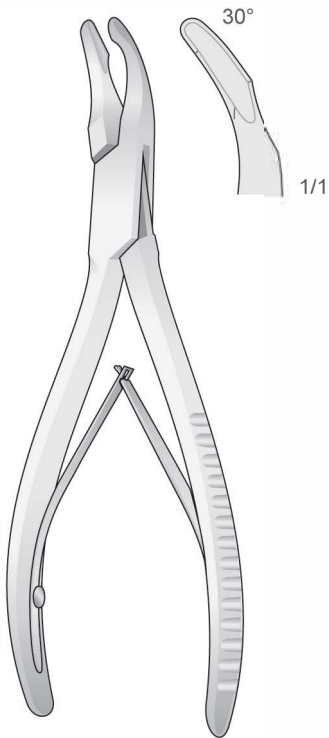

CLEVELAND
wi-11290 140 mm
wi-11291 170 mm

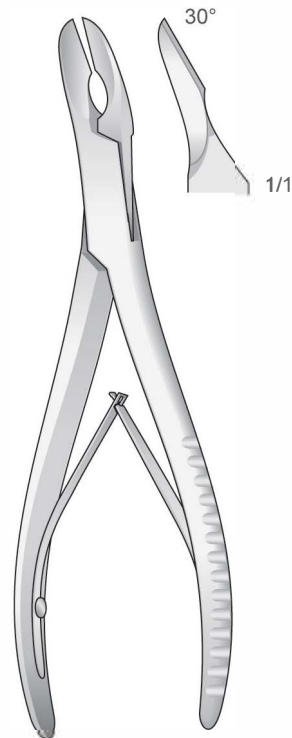

CLEVELAND
wi-11292 150 mm
wi-11293 170 mm

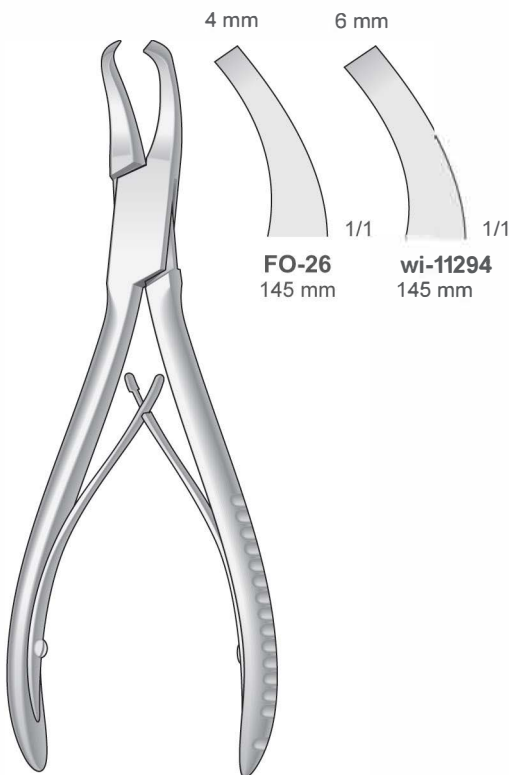

GARDNER
wi-11296
 145 mm

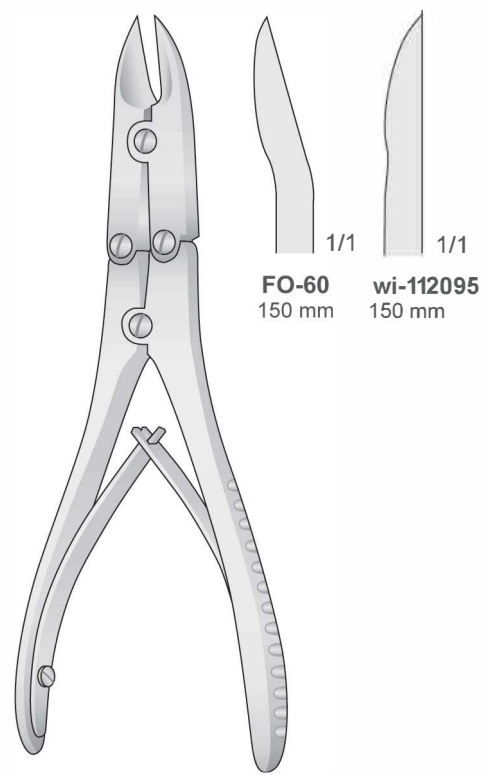

BÖHLER
wi-11297
 150 mm



Zahnsonden
Explorers - Sickle Probes
Esploratori - Sonde falce
Sondas exploradoras
Sondes exploratrices

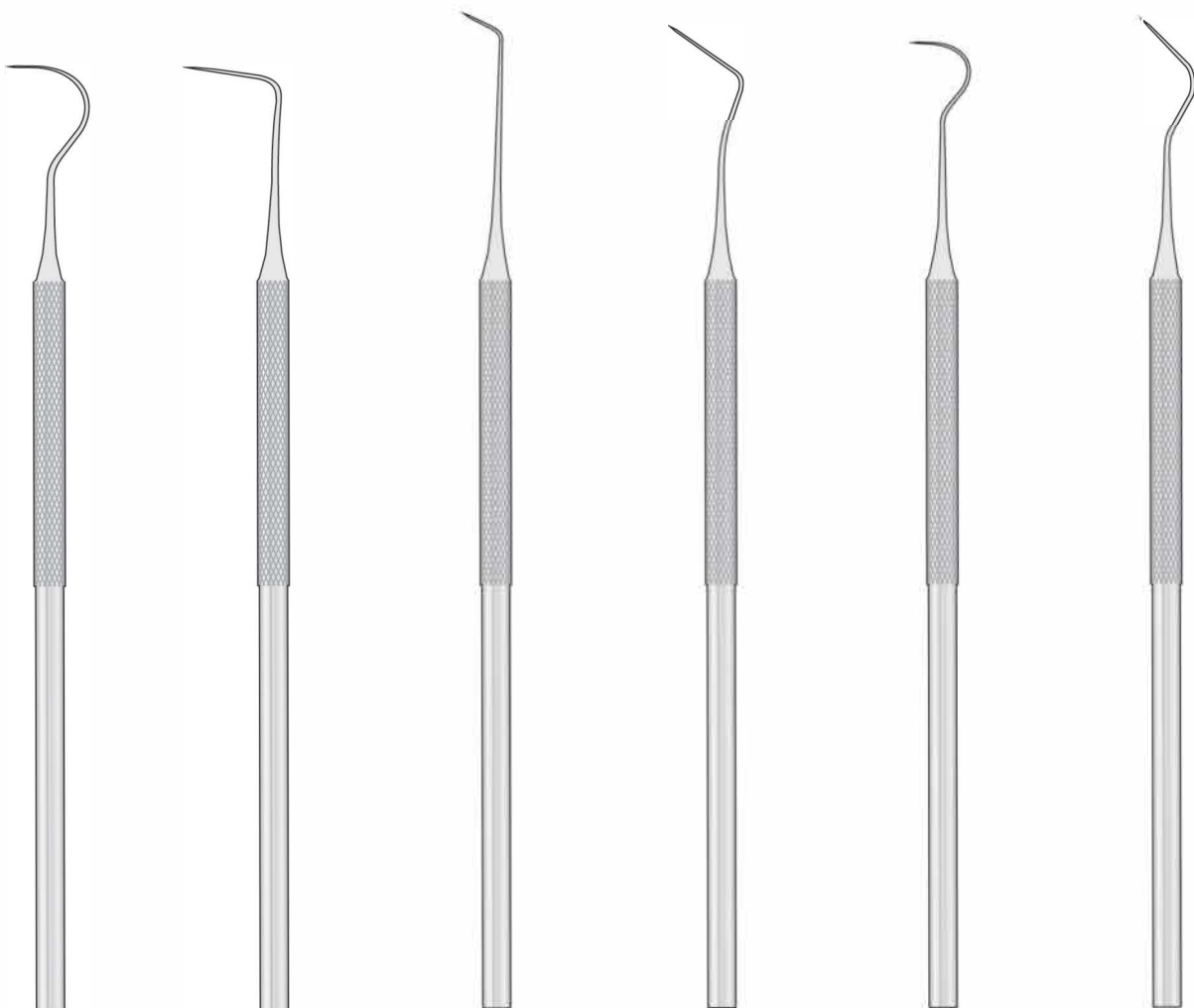

wi-11298
Fig. 23

wi-11299
Fig. 11

wi-11300
Fig. 6

wi-11301
Fig. 9

wi-11302
Fig. 2

wi-11303
Fig. 10



Zahnsonden
Explorers - Sickle Probes
Esploratori - Sonde falce
Sondas exploradoras
Sondes exploratrices

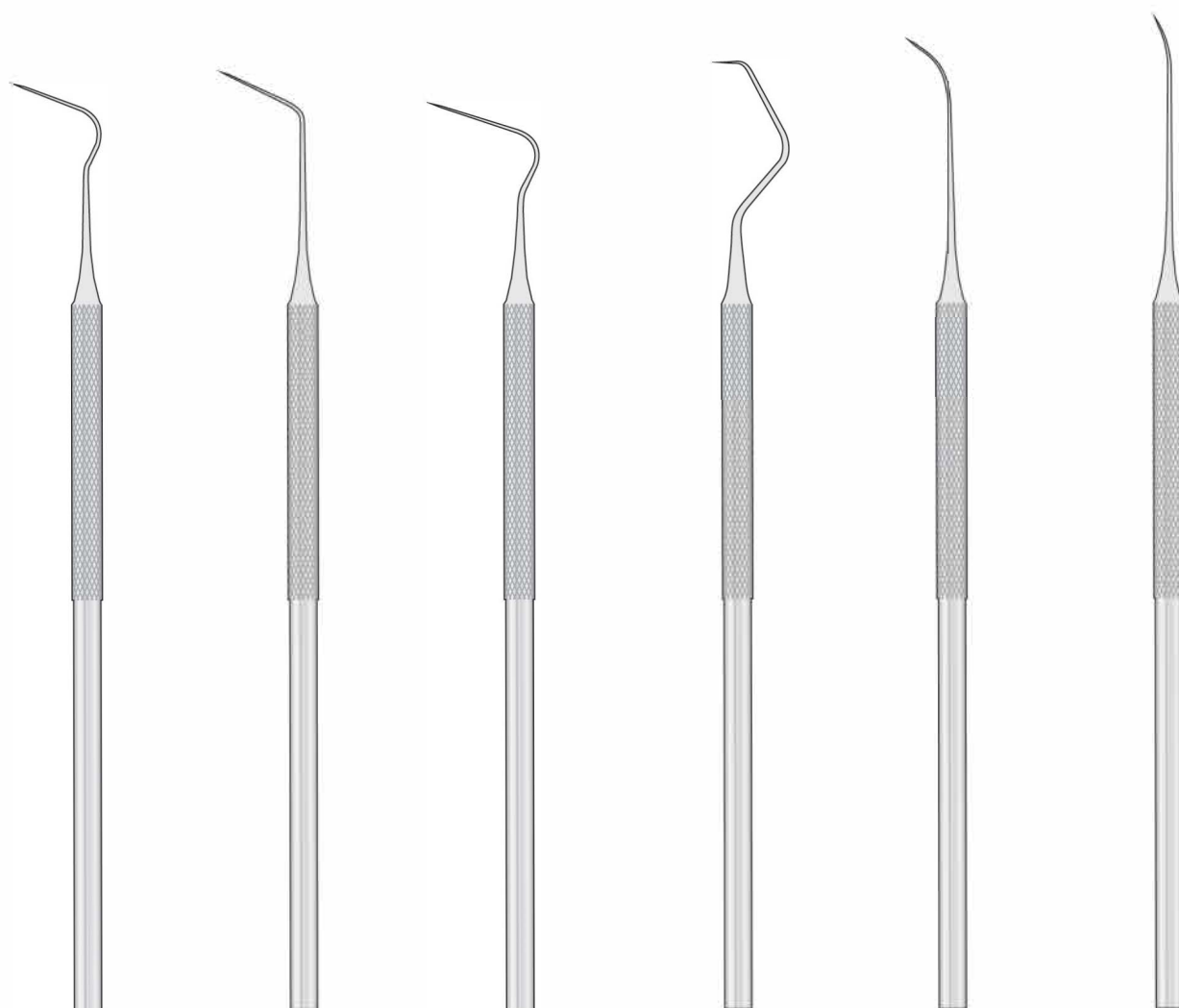

wi-11304
Fig. 12

wi-11305
Fig. 6A

wi-11306
Fig. 8A

wi-11307
Fig. 17A

wi-11308
Fig. 3A

wi-11309
Fig. 3



Parodontometer
 Periodontal Probes
 Sonde parodontali
 Sondas parodontales
 Sondes parodontales

Do not use Ultrasonic Cleaning
 Verwenden Sie keine Ultraschall-Reinigung
 Ne pas utiliser nettoyage à ultrasons
 No usar limpieza ultrasónica
 Non usare lavatrici ad ultrasuoni



Do not use metal brushes
 Keine Drahtbürste verwenden
 Ne pas utiliser de brosses métalliques
 No utilizar cepillos metálicos
 Non utilizzare spazzole metalliche

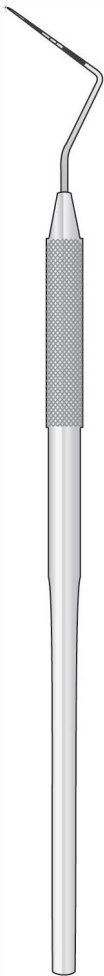

CP-11
wi-11310
 160 mm

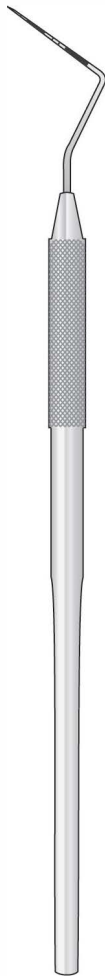

CP-12
wi-11311
 160 mm

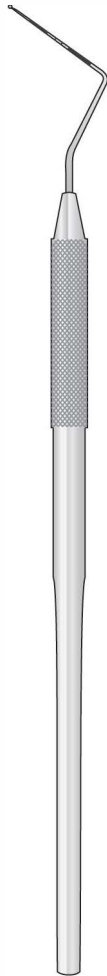
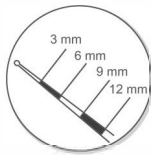

CP-12S
wi-11312
 160 mm

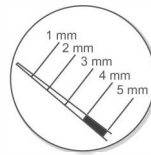

CP-15UNC
wi-11313
 160 mm

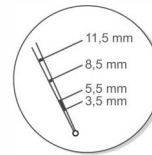

WHO
wi-11314
 160 mm

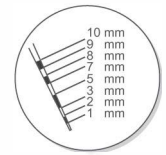

CP-10
wi-11315
 160 mm



Parodontometer
 Periodontal Probes
 Sonde parodontali
 Sondas parodontales
 Sondes parodontales

Double-ended Explorer
 Doppelendiger Zahnsonden
 Sonde exploratrice double
 Sonda exploradora doble
 Sonda falce doppia



11/12 ODU
 wi-11316
 165 mm

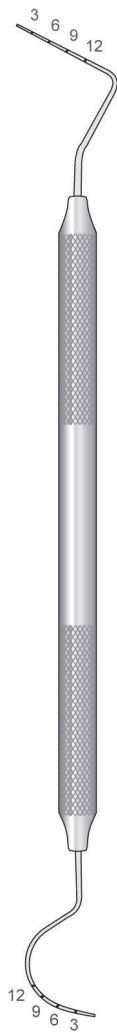

UT3/4 CATTONI
 wi-11317
 165 mm



2QN NABERS
 wi-11318
 175 mm



23 CP-11
 wi-11319

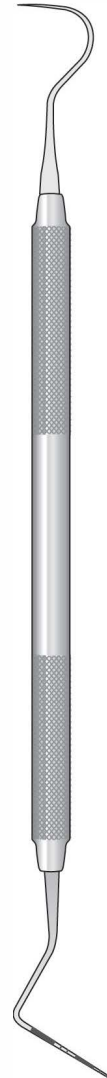
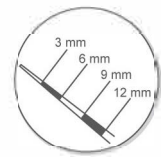

23 CP-12
 wi-11320



Parodontometer
Periodontal Probes
Sonde parodontali
Sondas parodontales
Sondes parodontales





Instrumente für Endodontie
 Endodontic Instruments
 Strumenti per Endodonzia
 Instrumentos para Endodoncia
 Instruments pour Endodontie

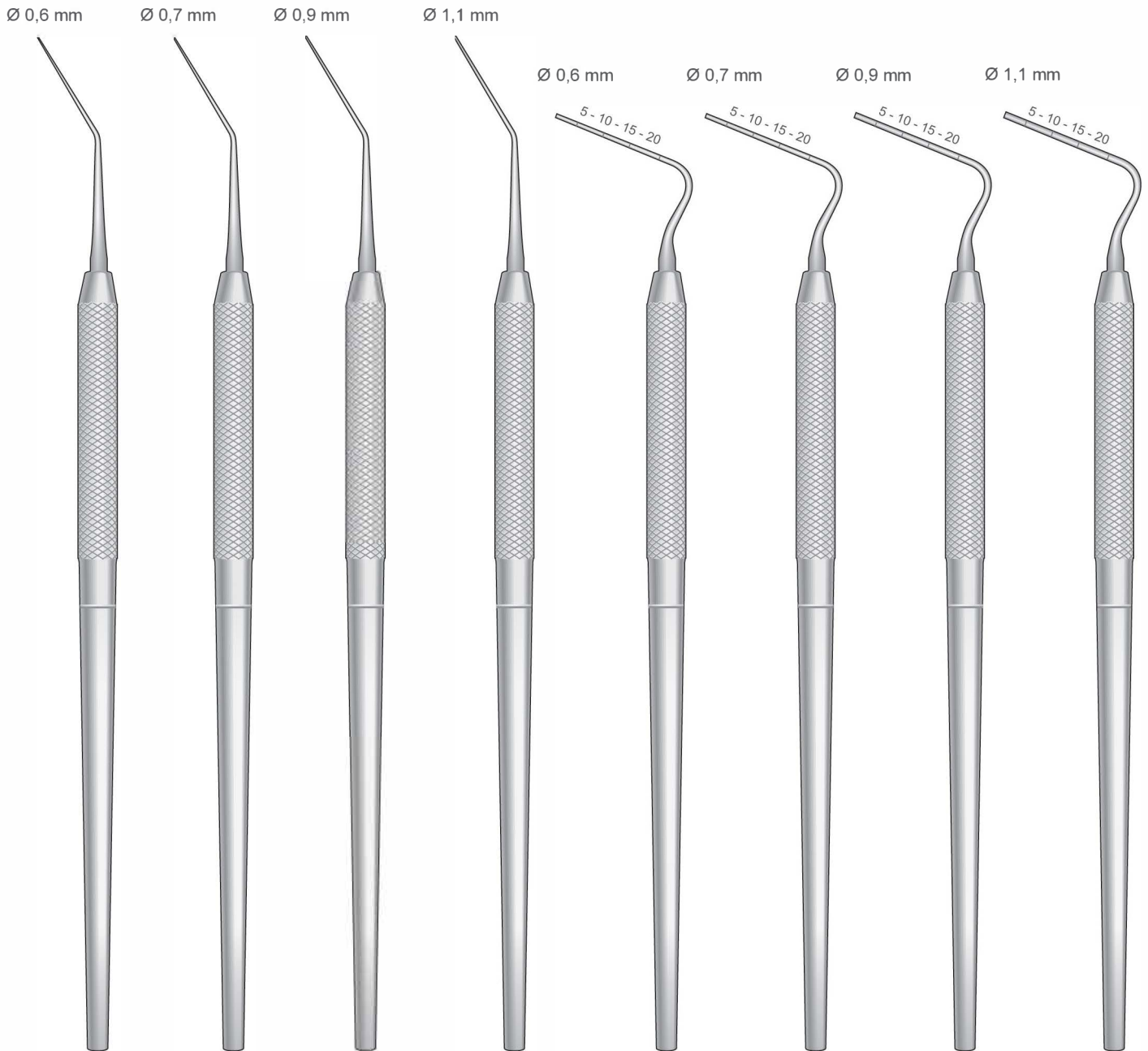

LUKS
wi-11327
 Fig.1

LUKS
wi-11328
 Fig.2

LUKS
wi-11329
 Fig.3

LUKS
wi-11330
 Fig.4

wi-11331
 Fig.1

wi-11332
 Fig.2

wi-11333
 Fig.3

wi-11334
 Fig.4



Instrumente für Endodontie
Endodontic Instruments
Strumenti per Endodonzia
Instrumentos para Endodoncia
Instruments pour Endodontie

Spreaders

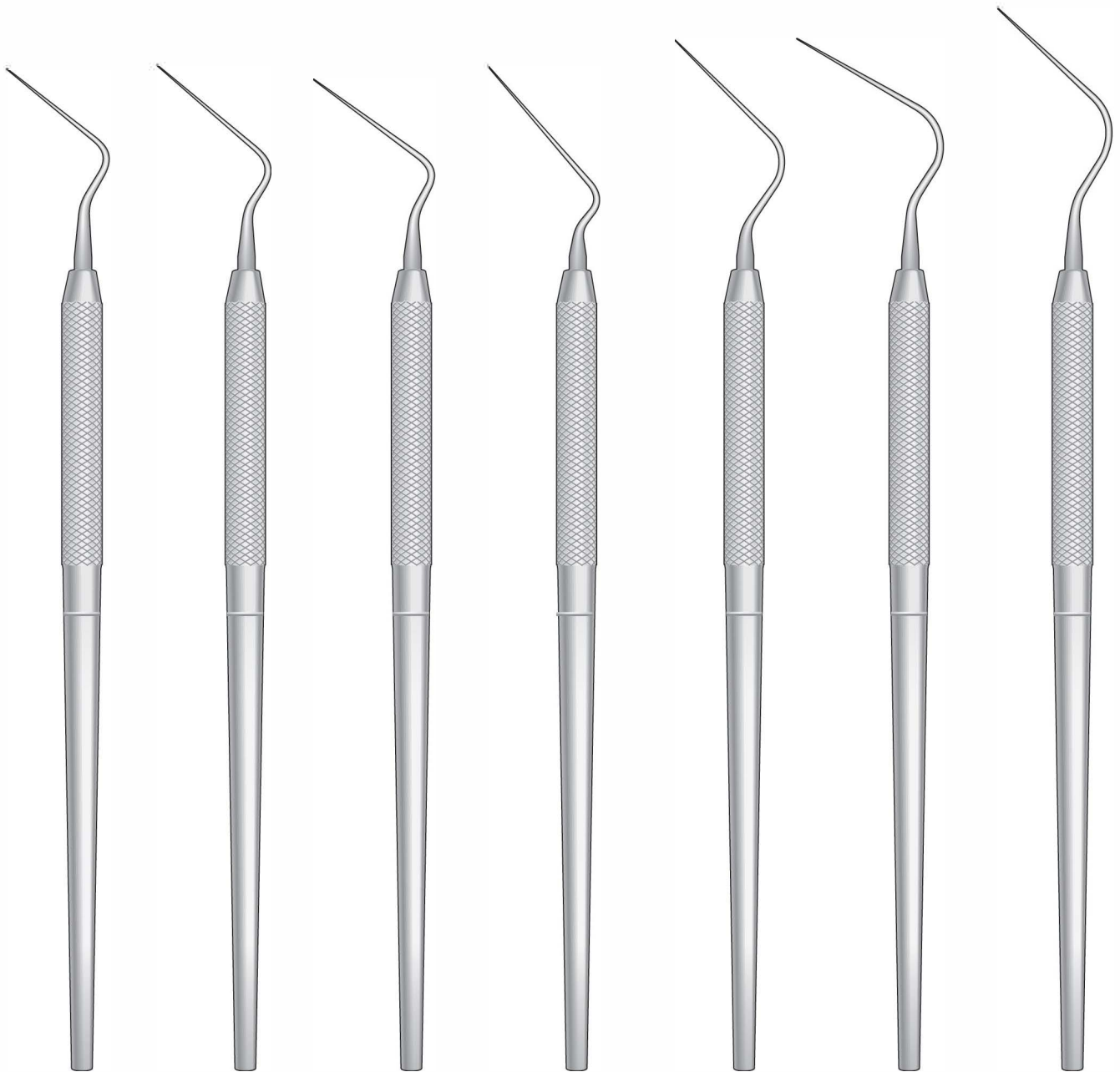

wi-11335
Fig.1S

wi-11335
Fig.2S

wi-11336
Fig.D11

wi-11337
Fig.MA57

wi-11338
Fig.0

wi-11399
Fig.00

wi-11340
Fig.3



Mundspiegel und Griffe
Mirrors and handles
Specchietti e manici
Espejos y mangos
Miroirs et manches

Rhodiumspiegel
Rhodium Mirror
Specchietto rodato
Espejo de rodio
Miroir au rhodium



Box of 12

wi-11341		
# 3 - Ø 18mm	wi-113042	
# 4 - Ø 22mm	wi-113043	
# 5 - Ø 24mm		

Flach
Plane
Piano
Plano
Plan

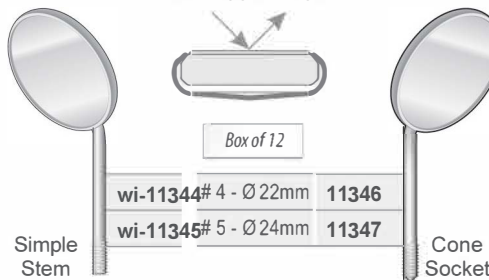

Box of 12

wi-11344	# 4 - Ø 22mm	11346
wi-11345	# 5 - Ø 24mm	11347

Simple Stem
Cone Socket



Box of 12

wi-11348	# 3 - Ø 18mm	
wi-11349	# 4 - Ø 22mm	
wi-11350	# 5 - Ø 24mm	

Hohl-Vergrößernd
Concave with enlarging effect
Concavo con ingrandimento
Còncavo con efecto de aumento
Creux avec effect d'agrandissant

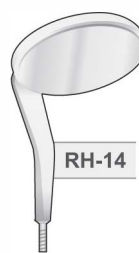

Box of 6

RH-14 # 4 - Ø 22mm

MEGA DUO RHODIUM n.4

Beidseitig Rhodium Beschichtet
Both sides Rhodium-coated
Con rivestimento in rodio su entrambi i lati
Revestido con rodio en ambos lados
Revêtu de rhodium des deux côtés

Massiv - Solid
Pieno - Sólido - Solide

Hohl - Hollow
Vuoto - Hueco - Creux



wi-11351
Simple Stem
120 mm

MA-1A
Cone Socket
120 mm

wi-11353
Simple Stem
125 mm

wi-11354
Cone Socket
125 mm

inox
STAINLESS STEEL

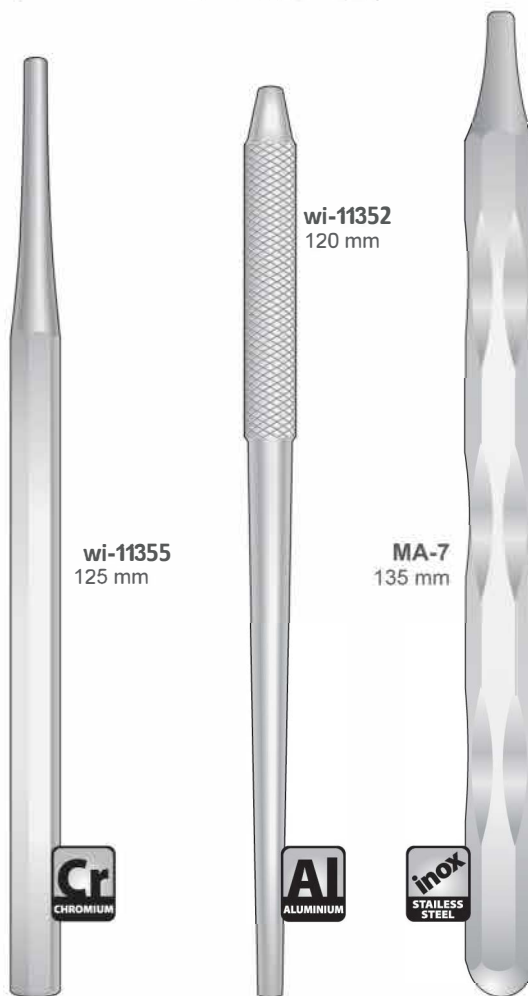

wi-11352
120 mm

MA-7
135 mm

wi-11355
125 mm

Cr
CHROMIUM

Al
ALUMINIUM

inox
STAINLESS STEEL

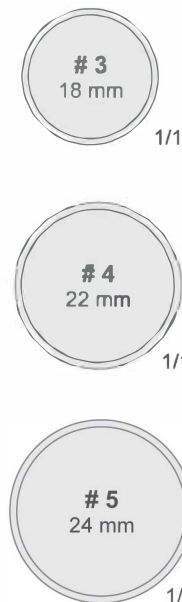



Mundspiegel und Griffe
Mirrors and handles
Specchietti e manici
Espejos y mangos
Miroirs et manches

Spiegeldurchmesser - Diameter of mirrors
Diametro dello specchio - Diamètre des miroirs
Diámetro de los espejos

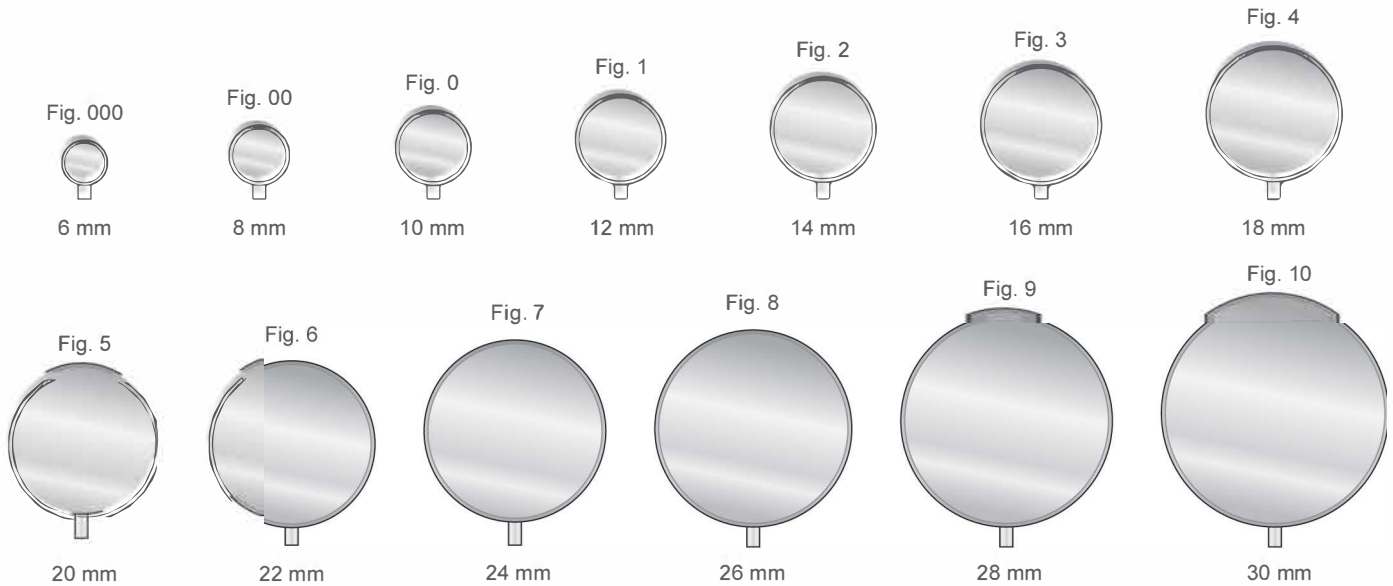

Kehlkopfspiegel mit Sechskantgriff
Laryngeal mirrors with hexagonal handle
Specchietto laringeo con manico esagonale
Espejo laringeo con mango hexagonal
Miroirs laryngiens avec manche hexagonal

- G-8 Fig. 00
- wi-11356 Fig. 0
- wi-11357 Fig. 1
- wi-11358 Fig. 2
- wi-113059 Fig. 3
- wi-11390 Fig. 4
- wi-11361 Fig. 5
- wi-11362 Fig. 6
- wi-11363 Fig. 7
- wi-11364 Fig. 8
- wi-11365 Fig. 9
- wi-11366 Fig. 10

wi-11376
180 mm

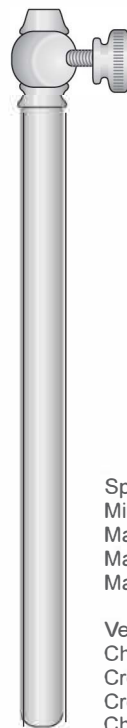

Spiegelgriff
Mirrors handle
Manico per specchietti
Mango para espejos
Manche à miroir

Verchromt
Chromium
Cromato
Cromado
Chromé

wi-11377
120 mm



Kehlkopfspiegel
Laryngeal mirrors
Specchietto laringeo
Espejos laringeos
Miroirs laryngiens

- wi-11367 Fig. 000
- wi-11368 Fig. 00
- wi-11369 Fig. 0
- wi-11370 Fig. 1
- wi-11371 Fig. 2
- wi-11372 Fig. 3
- wi-11373 Fig. 4
- wi-11374 Fig. 5
- wi-11375 Fig. 6

wi-11378
120 mm



Dental-Spritzen
Dental Syringes
Siringhe dentali
Jeringas dentales
Seringues dentaires



wi-11379
Aspirating
for Imperial Tip
(North America)
140mm



wi-11380
Self Aspirating
for Imperial Tip
(North America)
140mm

wi-11381
Self Aspirating
for Metric Tip
(Europe)
140mm

Spritzen zur lokalen Interligamentär-Anästhesie
Syringes for Intraligamental anaesthesia
Siringa per anestesia intraligamentare
Jeringa intraligamnetaria para anestesia
Seringues pour anesthésies intraligamentaires

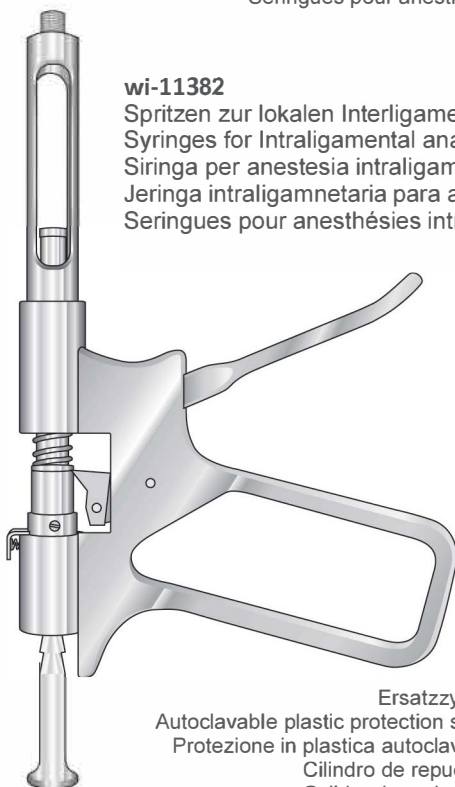

wi-11382
Spritzen zur lokalen Interligamentär-Anästhesie
Syringes for Intraligamental anaesthesia
Siringa per anestesia intraligamentare
Jeringa intraligamnetaria para anestesia
Seringues pour anesthésies intraligamentaires



wi-11384
Ersatzzylinder für SD-7
Autoclavable plastic protection sleeve for SD-7
Protezione in plastica autoclavabile per SD-7
Cilindro de repuesto para SD-7
Cylindre de rechange pour SD-7

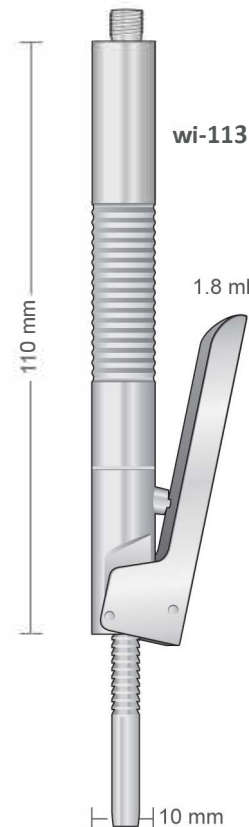

wi-113083

1.8 ml

110 mm

10 mm



Dental-Spritzen
Dental syringes
Siringhe dentali
Jeringas dentales
Seringues dentaires

Zylinder-Ampullen Spritzen
Cartridge Syringes
Siringhe per tubofiale
Jeringas de ampollas
Seringues d'ampoules

Aufsatz
Spare cap only
Adattatore solo
Adaptador suelto
Embout seul

Aufsatz
Spare cap only
Adattatore solo
Adaptador suelto
Embout seul

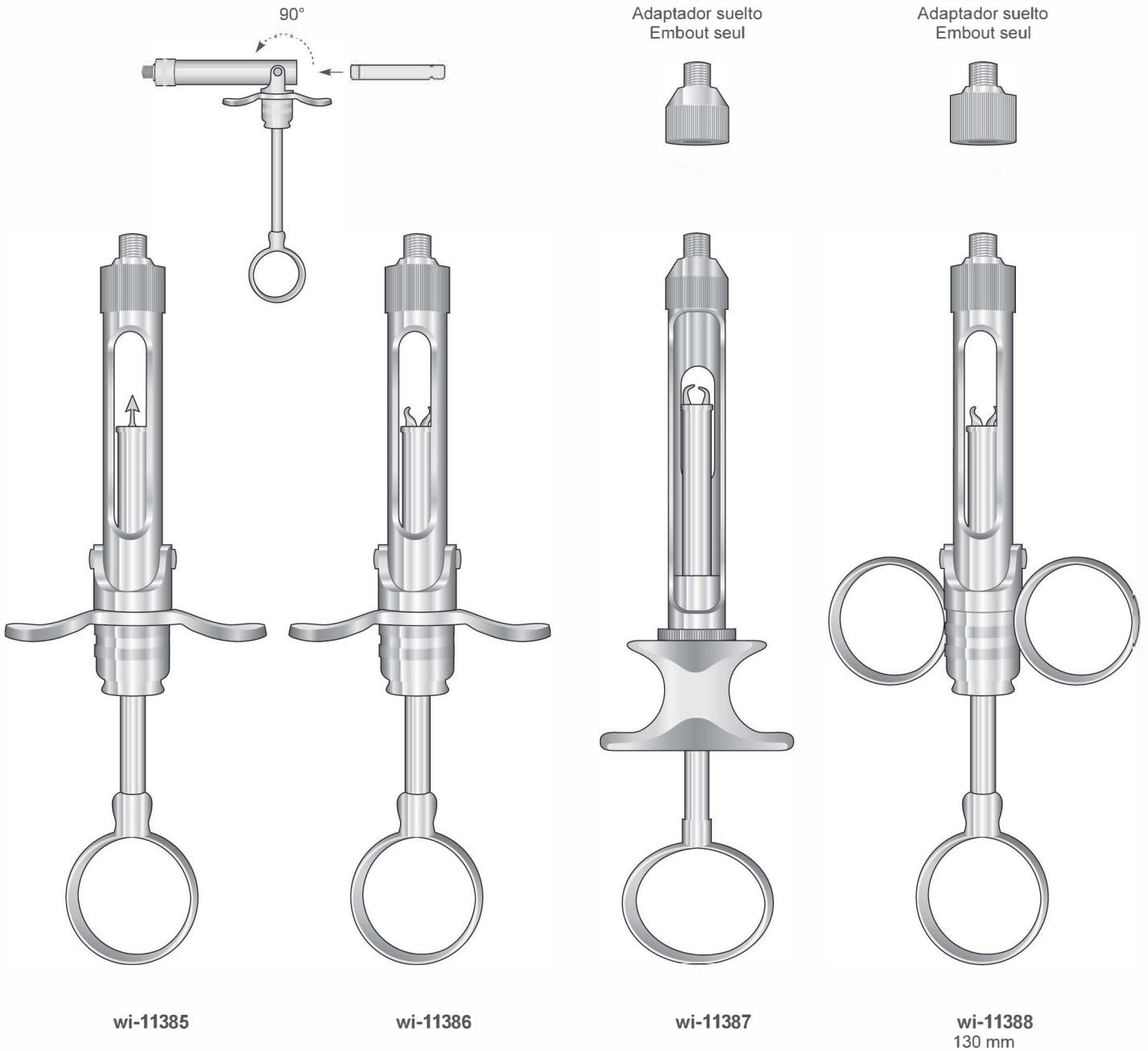



Küretten
Curettes
Curette
Curetas
Curettes



GRACEY
wi-11399



GRACEY
wi-11389



GRACEY
wi-11390



GRACEY
wi-113891



GRACEY
wi-11394



GRACEY
wi-11395



GRACEY
wi-11396

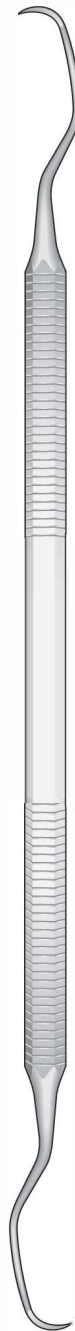

LANGER Fig. 1/2
wi-11400



LANGER Fig. 3/4
wi-11392



COLUMBIA
wi-11393



COLUMBIA
wi-11397



COLUMBIA
wi-11398



Hollow
Hohl
Creux
Hueco
Vuoto



Ø 9 mm

Elite
Scaler und Kùretten
Scalers and Curettes
Scaler e Curette
Raspadores y Curetas
Détartreurs et Curettes



wi-11401
Gracey
Curette 1/2ET



wi-11402
Gracey
Curette 3/4ET



wi-11403
Gracey
Curette 5/6ET



wi-11404
Gracey
Curette 7/8ET



wi-11405
Gracey
Curette 9/10ET



wi-11406
Gracey
Curette 11/12ET



wi-11407
Gracey
Curette 13/14ET



wi-11408
Gracey
Curette 15/16ET

Elite Scalers and Curettes Extra Thin

Balanced and ergonomic for great tactile working ability.

Extra light hollow handle for optimum comfort (feather weight / round Ø 9 mm).

Maintains long sharp edges.



Scaler und Kùretten
 Scalers and Curettes
 Scaler e Curette
 Raspadores y Curetas
 Détartreurs et Curettes



Hollow
 Hohl
 Creux
 Hueco
 Vuoto



Ø9 mm



wi-11409
 Gracey
 Curette 1/2



wi-11410
 Gracey
 Curette 3/4



wi-11411
 Gracey
 Curette 5/6



wi-11412
 Gracey
 Curette 7/8



wi-11413
 Gracey
 Curette 9/10



wi-11414
 Gracey
 Curette 11/12



wi-11415
 Gracey
 Curette 13/14



wi-11416
 Gracey
 Curette 1/2S



wi-11417
 Gracey
 Curette 3/4S



wi-11418
 Gracey
 Curette 5/6S



wi-11419
 Gracey
 Curette 7/8S



wi-11420
 Gracey
 Curette 9/10S



wi-11421
 Gracey
 Curette 11/12S



wi-11422
 Gracey
 Curette 13/14S

Elite Scalers and Curettes

Balanced and ergonomic for great tactile working ability.
 Extra light hollow handle for optimum comfort (feather weight / round Ø 9 mm).
 Maintains long sharp edges.



Hollow
Hohl
Creux
Hueco
Vuoto



Ø9 mm

Scaler und Küretten
Scalers and Curettes
Scaler e Curette
Raspadores y Curetas
Détartréurs et Curettes



- | | | | | | | | |
|--|--|--|--|--|--|---|---|
| | | | | | | | |
| | wi-11423
Gracey
Curette 1/2L | wi-11424
Gracey
Curette 3/4L | wi-11425
Gracey
Curette 5/6L | wi-11426
Gracey
Curette 7/8L | wi-11427
Gracey
Curette 9/10L | wi-11428
Gracey
Curette 11/12L | wi-11429
Gracey
Curette 13/14L |
| | | | | | | | |
| | wi-11430
Gracey
Curette 15/16 | wi-11431
Gracey
Curette 17/18S | wi-11432
Kramer
Curette 1 | wi-11433
Kramer
Curette 3 | wi-11434
Kramer-Nevis
Chisels 1/2 | wi-11435
McCall
Scaler 11/12 | wi-11436
McCall
Curette 13/14 |
| | | | | | | | |
| | wi-11437
McCall
Curette 13S/14S | wi-11438
McCall
Curette 17S/18S | wi-11439
Columbia
Curette 2RL | wi-11440
Columbia
Curette 4RL | wi-11441
Columbia
Curette 13/14 | wi-11442
Langer
Curette 5/6 | |



Scaler und Kùretten
 Scalers and Currettes
 Scaler e Curette
 Raspadores y Curetas
 Détartreurs et Curettes



Hollow
 Hohl
 Creux
 Hueco
 Vuoto



Ø9 mm

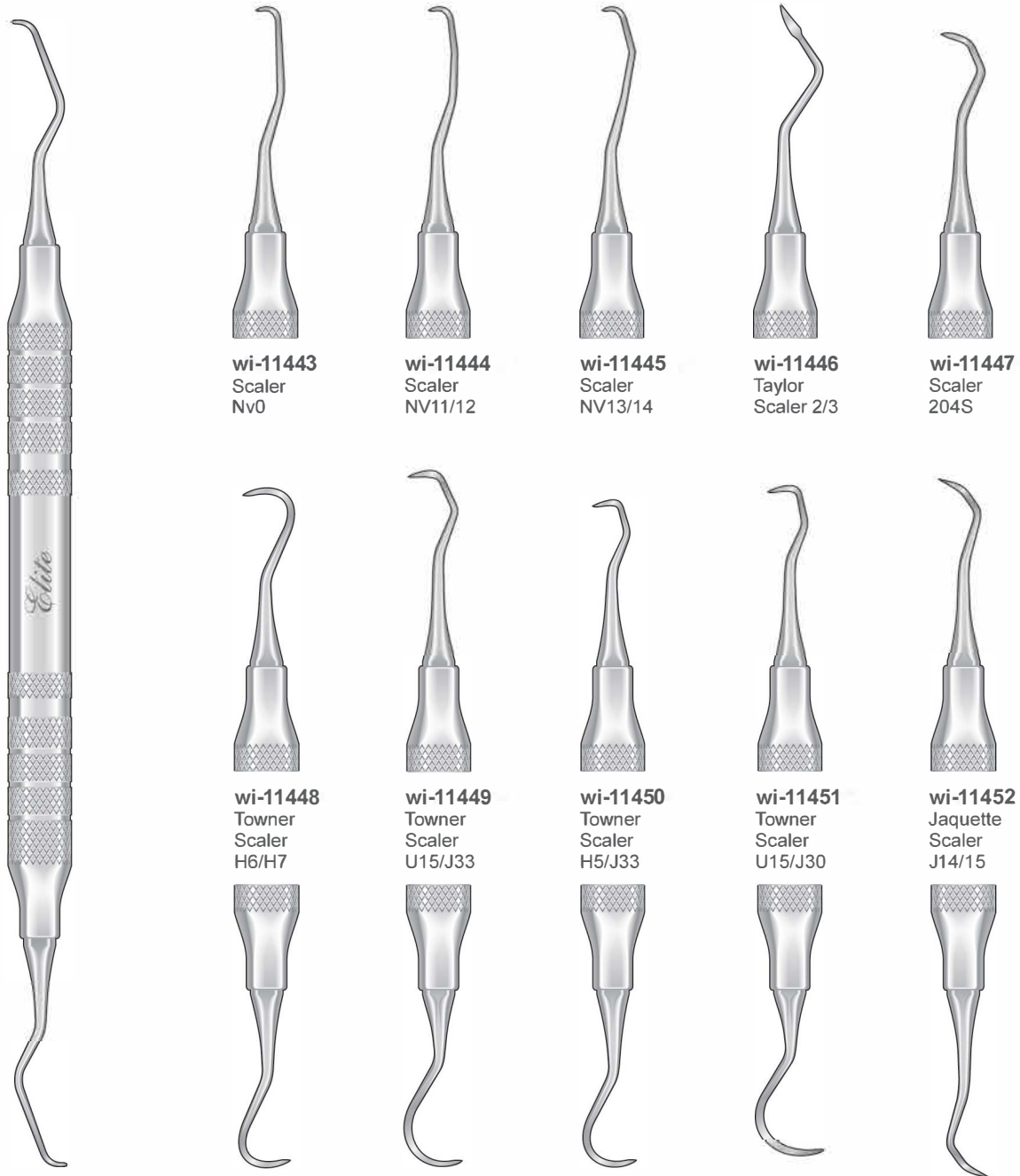

wi-11443
 Scaler
 NV0

wi-11444
 Scaler
 NV11/12

wi-11445
 Scaler
 NV13/14

wi-11446
 Taylor
 Scaler 2/3

wi-11447
 Scaler
 204S

wi-11448
 Towner
 Scaler
 H6/H7

wi-11449
 Towner
 Scaler
 U15/J33

wi-11450
 Towner
 Scaler
 H5/J33

wi-11451
 Towner
 Scaler
 U15/J30

wi-11452
 Jaquette
 Scaler
 J14/15

Elite Scalers and Cures

Balanced and ergonomic for great tactile working ability.
 Extra light hollow handle for optimum comfort (feather weight / round Ø 9 mm).
 Maintains long sharp edges.



Küretten - Feilen
 Curettes - Files
 Curette - Lime
 Curetasc - Lima
 Curettes - Limes

Universal Küretten
 Universal Curettes
 Curette universali
 Curetas universales
 Curettes universelles

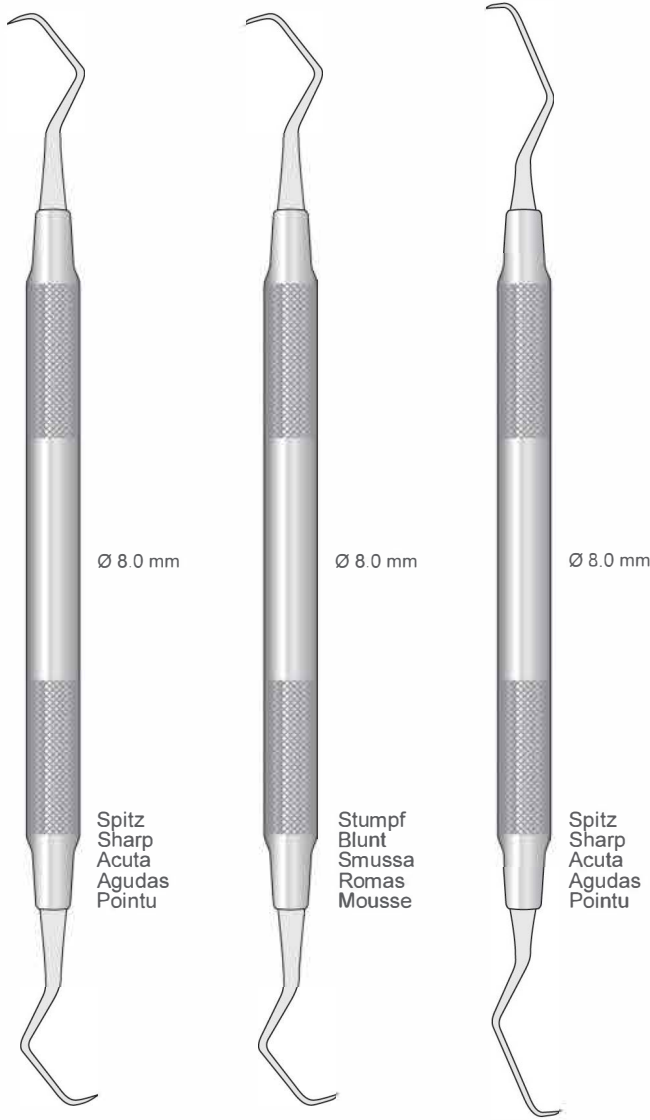

wi-11453
165 mm

wi-11454
165 mm

wi-11455
170 mm

Parodontalfeilen
 Periodontal Files
 Lime parodontali
 Limas parodontales
 Limes parodontales



HIRSCHFELD
wi-11456
170 mm

HIRSCHFELD
wi-11457
170 mm

HIRSCHFELD
wi-11458
175 mm



Amalgamträger
Amalgam Carriers
Porta amalgama
Porta-amalgamas
Porte-amalgames

Amalgambecher
Amalgam Well
Mortaino per amalgama
Vaso para amalgama
Gobelet pour amalgame



wi-11459
Ø 35 mm
h. 35 mm



wi-11460

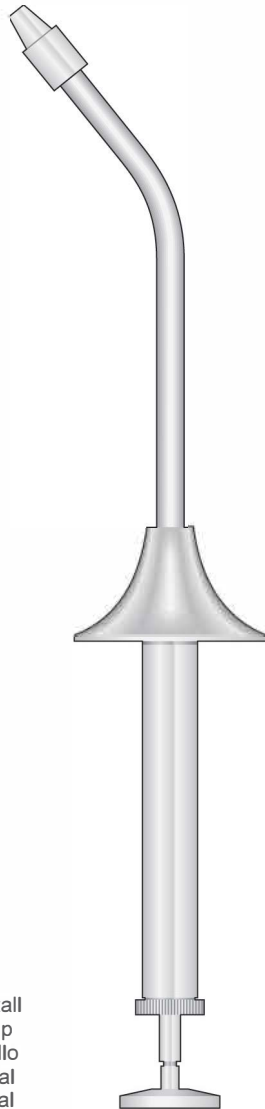

wi-11461

Aus Metall
Metal tip
In metallo
De metal
En métal

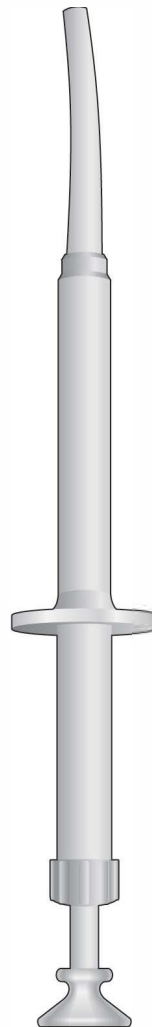

wi-11462
170 mm

Autoclavable
Aus Kunststoff
Plastic tip
In plastica
De plàstico
En plastique

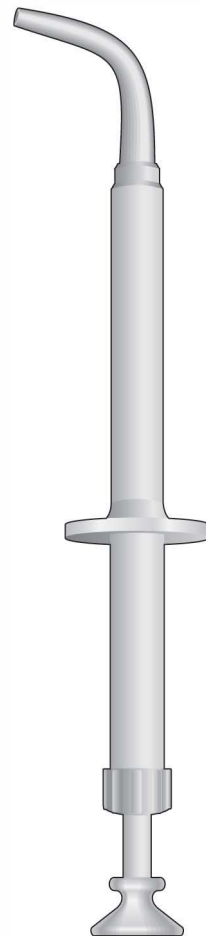

wi-11463
160 mm



Amalgam Instrumente
 Amalgam Carvers
 Strumenti per modellare l'amalgama
 Instrumentos para modelar las obturaciones
 Instruments à modeler l'amalgame

Instrument für Drahrückzug
 Instrument for retractor wire
 Strumento per filo retrattore
 Instrumento para hilo separador
 Instruments pour fil séparateur

Cleoids - Discoids

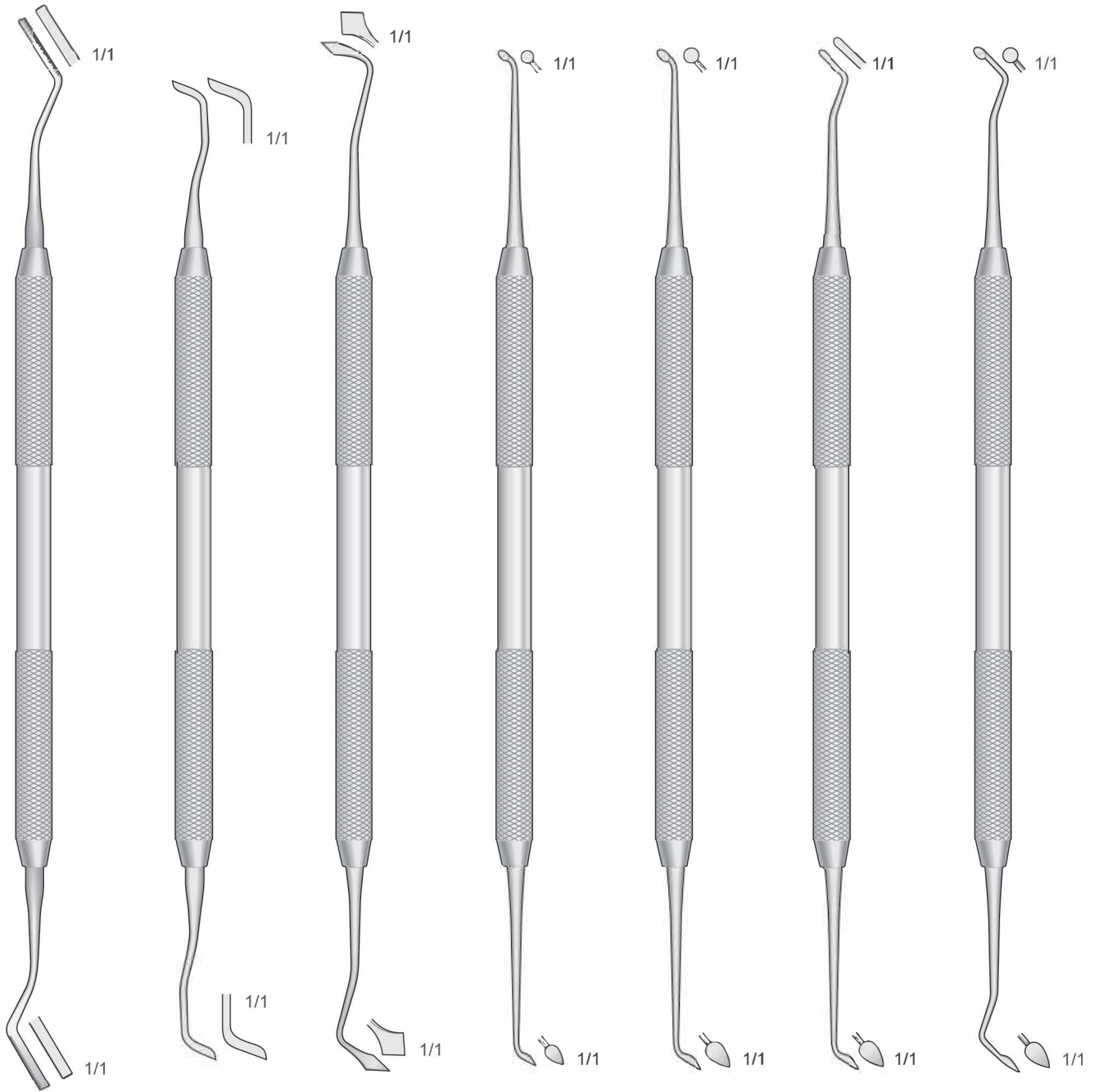

wi-11464

wi-11465
 USC

wi-11466
 FRAHM

wi-11467
 Fig. 1 / 2

wi-11468
 Fig. 4/5

wi-11469
 Fig. W.A.C.D.

wi-11470
 Fig. 3/6



Füllungsinstrumente
Filling Instruments
Strumenti per otturazione
Instrumentos para obturación
Instruments pour obturation

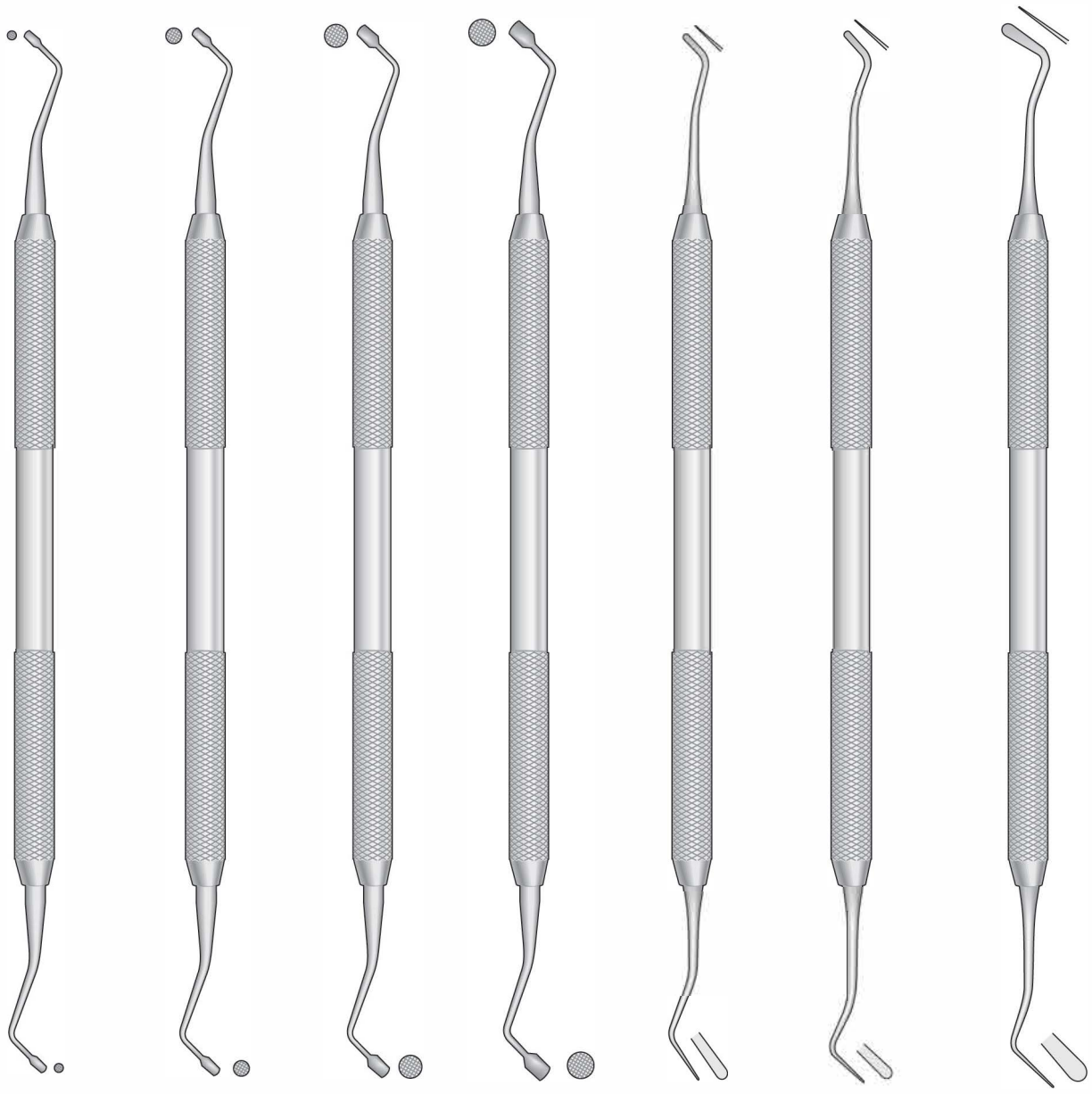

wi-11471

wi-11472

wi-11473

wi-11474

wi-11475

wi-11476

wi-11477



Füllungsinstrumente
 Filling Instruments
 Strumenti per otturazione
 Instrumentos para obturación
 Instruments pour obturation

Gerieft
 Serrated
 Zigrinati
 Estriados
 Striée

Glatt
 Smooth
 Lisci
 Lisos
 Lissée

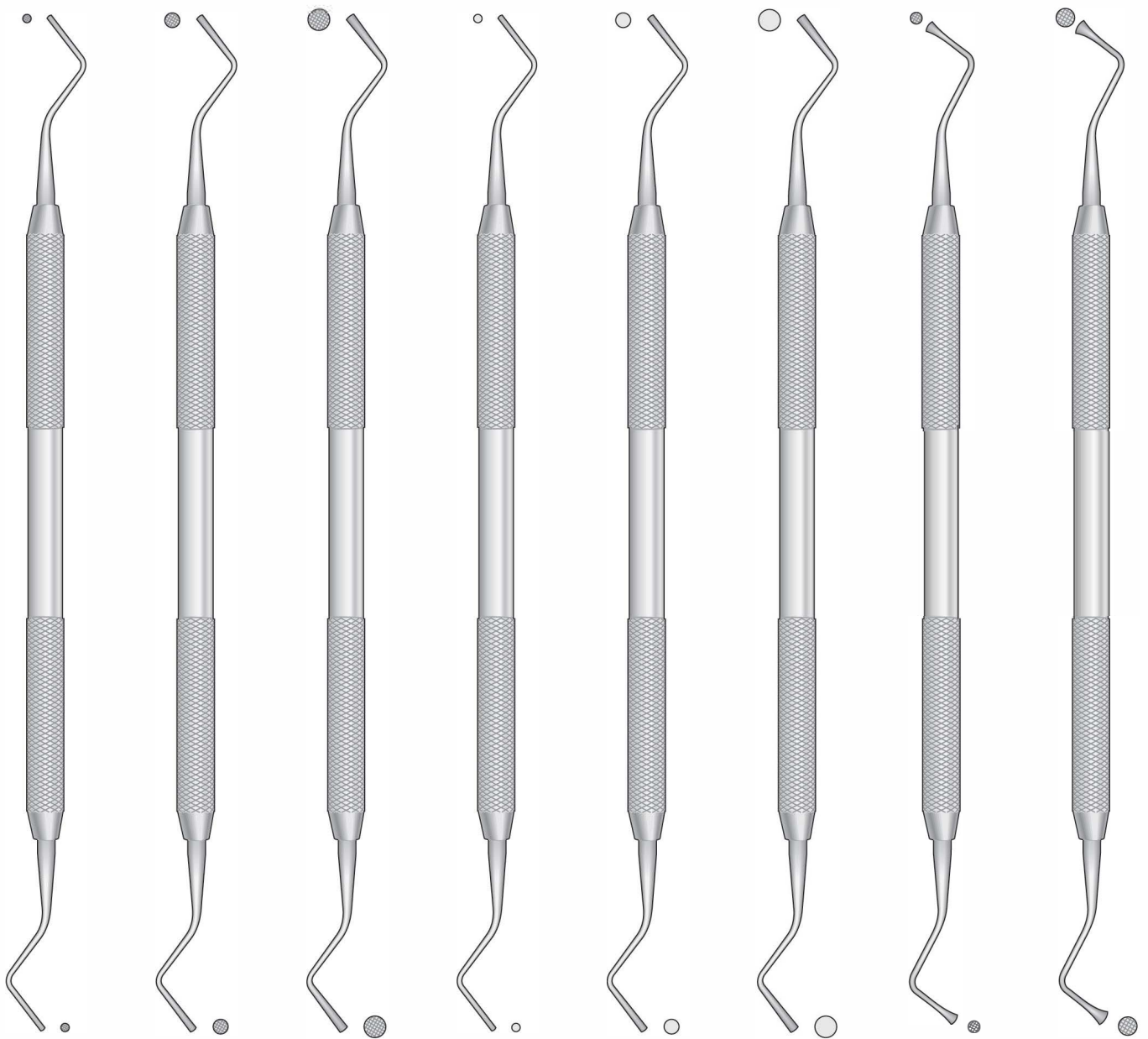

wi-11478
 Fig.1

wi-11479
 Fig.2

wi-11480
 Fig.3

wi-11481
 Fig.1L

wi-11482
 Fig.2L

wi-11483
 Fig.3L

WARD
 wi-11484

WARD
 wi-11485



Füllungsinstrumente
Filling Instruments
Strumenti per otturazione
Instrumentos para obturación
Instruments pour obturation

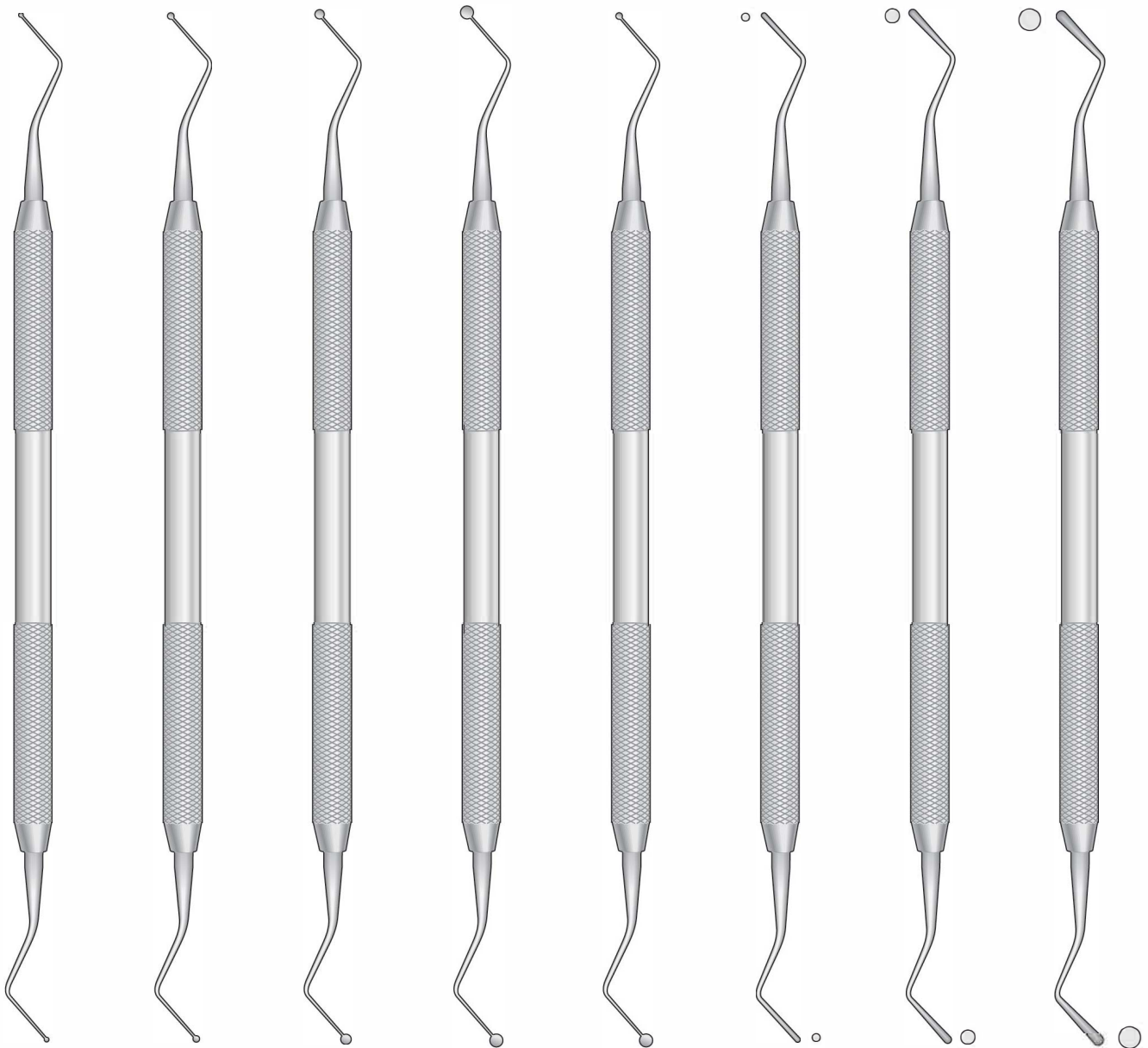

wi-11486
Fig.1

wi-11487
Fig.2

wi-11488
Fig.3

wi-11489
Fig.4

wi-11490
Fig.5

wi-11491
Fig.1

wi-11492
Fig.2

wi-11493
Fig.3



Füllungsinstrumente
Filling Instruments
Strumenti per obturazione
Instrumentos para obturación
Instruments pour obturation

MARKLEY PLUGGERS
Amalgam Instrumente
Amalgam Instruments
Strumenti per amalgama
Instrumentos para amalgama
Instruments à amalgame



wi-11494
Fig.1



wi-11495
Fig.2

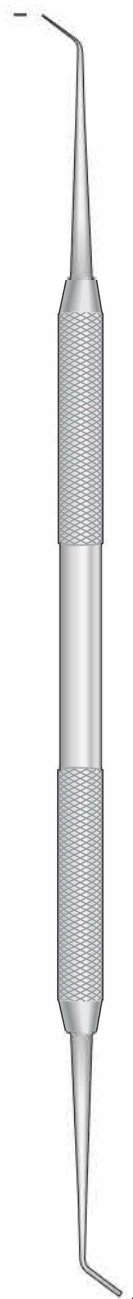

wi-11496
Fig.3

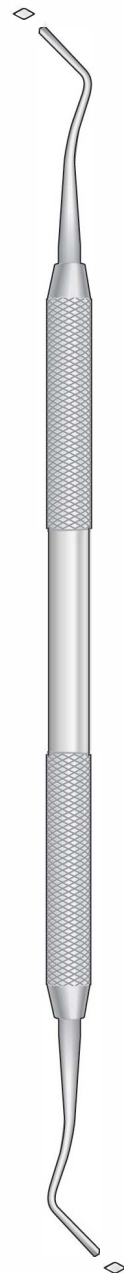

wi-11497
Fig.4



wi-11498
Fig.5



wi-11499
Fig.6



Spateln - Füllungsinstrumente
 Spatulas - Filling Instruments
 Spatole -Strumenti per otturazione
 Espátulas - Instrumentos para obturación
 Spatules - Instruments pour obturation

Heidemann Spateln
 Heidemann Spatulas
 Spatole Heidemann
 Espátulas Heidemann
 Spatules Heidemann

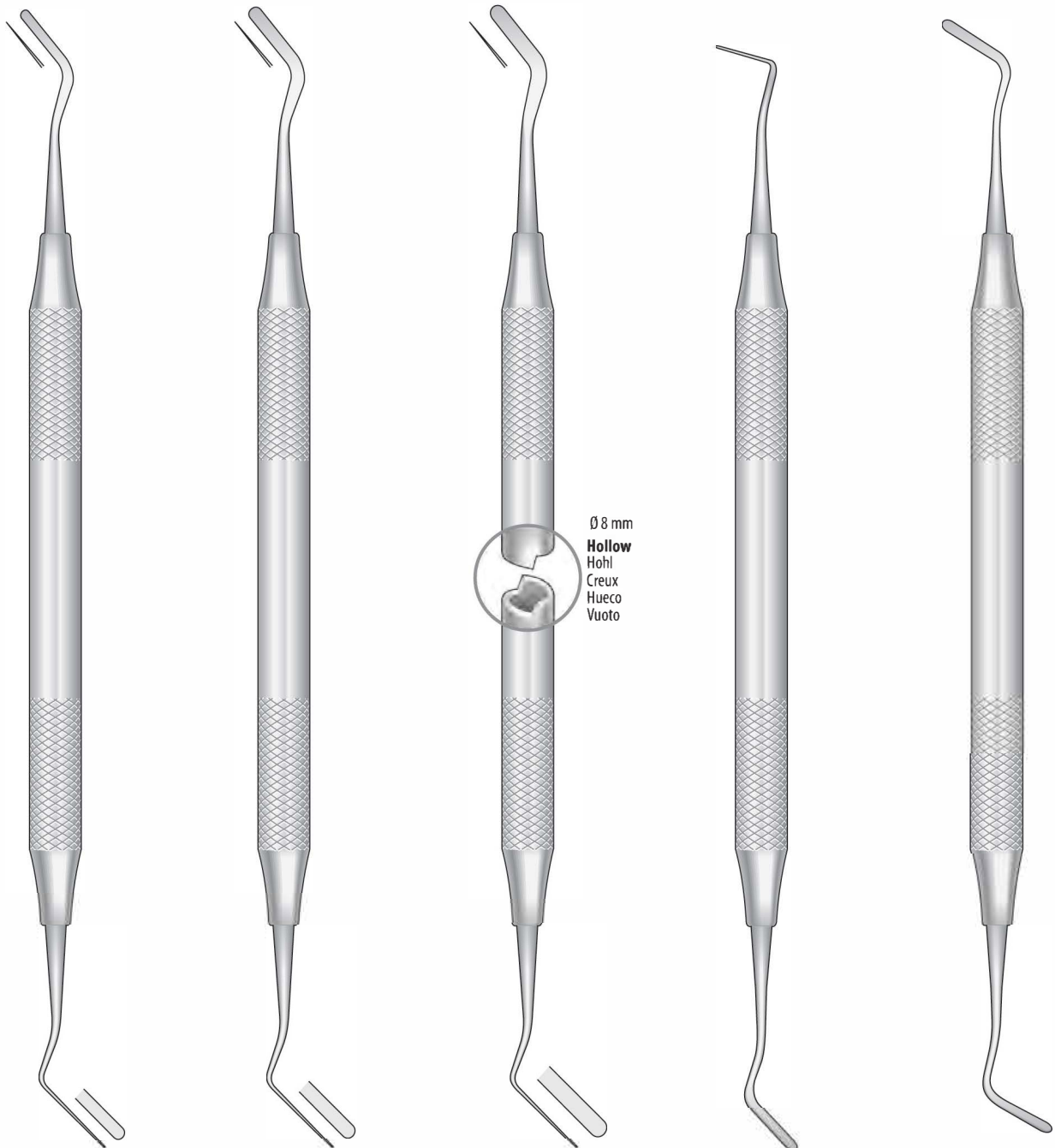

Ø 8 mm
Hollow
 Hohl
 Creux
 Hueco
 Vuoto

HEIDEMANN
wi-11500
 Fig.1

HEIDEMANN
wi-11501
 Fig.2

HEIDEMANN
wi-11502
 Fig.3

IPC Fig. 1
wi-11503
 Interproximal

IPC/OA Fig. 2
wi-11504
 Interproximal Off-Angle



Füllungsinstrumente
 Filling Instruments
 Strumenti per obturazione
 Instrumentos para obturación
 Instruments pour obturation

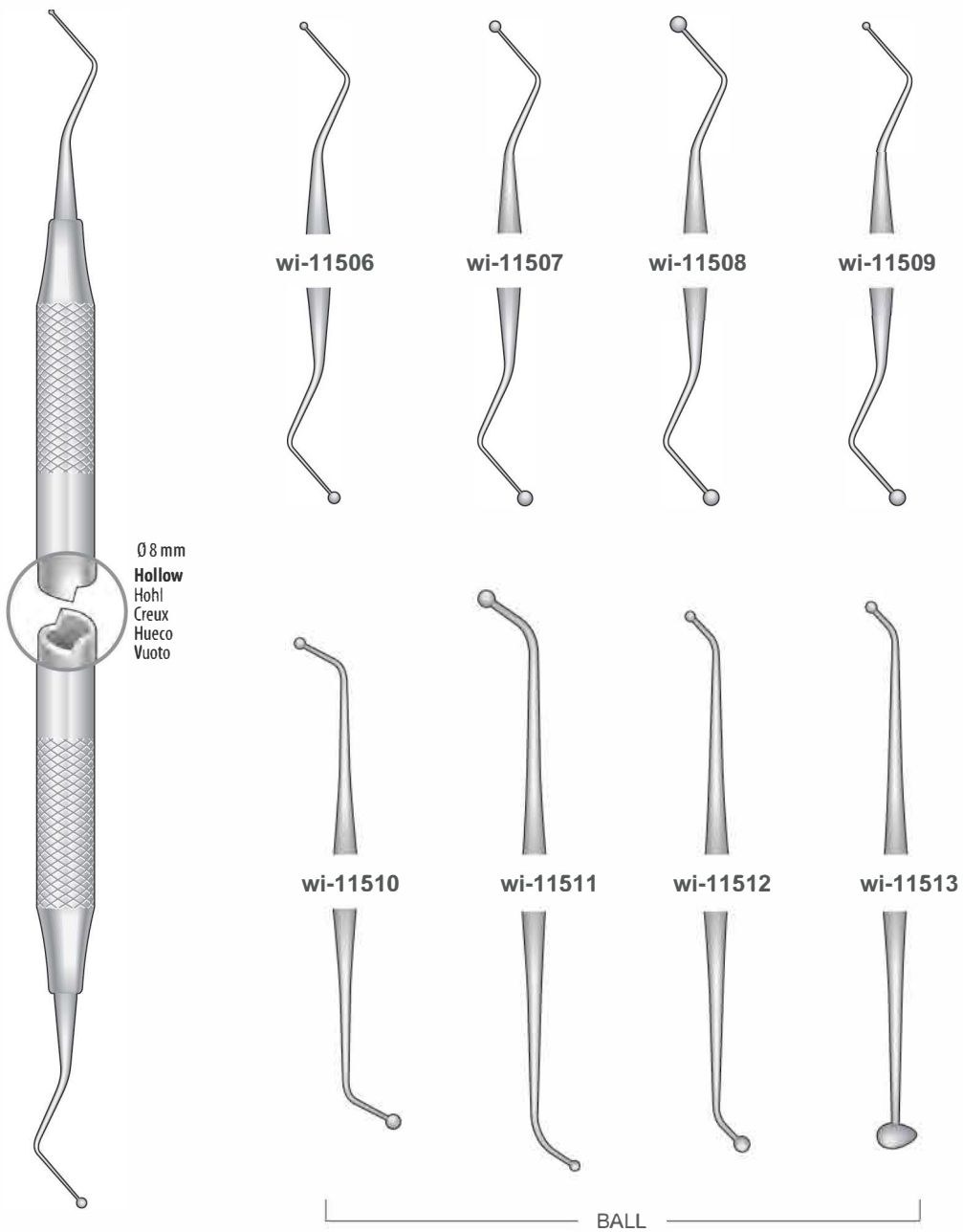

wi-11505















Füllungsinstrumente
 Filling Instruments
 Strumenti per otturazione
 Instrumentos para obturación
 Instruments pour obturation

















**Ø 8 mm
 Hollow
 Hohl
 Creux
 Hueco
 Vuoto**

Glatt - Smooth
 Lisci - Lisos
 Lissée

					
wi-11514	wi-11515	wi-11516	wi-11517	wi-11518	wi-11519
					

Gerieft - Serrated
 Zigrinati - Estriados
 Striés

						
wi-11520	wi-11521	wi-11522	wi-11523	wi-11524	wi-11525	wi-11526
						

wi-11527



Füllungsinstrumente
 Filling Instruments
 Strumenti per obturazione
 Instrumentos para obturación
 Instruments pour obturation

HOLLENBACK

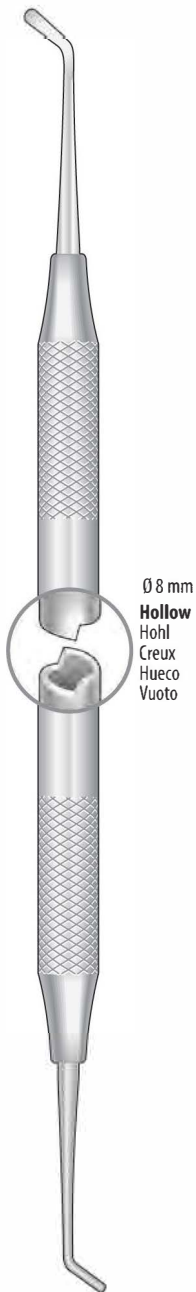

Ø 8 mm
Hollow
 Hohl
 Creux
 Hueco
 Vuoto

wi-11528



wi-11529



wi-11530



wi-11531



MARKLEY PLUGGERS

wi-115032



wi-11533



wi-11534
 170 mm



Füllungsinstrumente
 Filling Instruments
 Strumenti per otturazione
 Instrumentos para obturación
 Instruments pour obturation

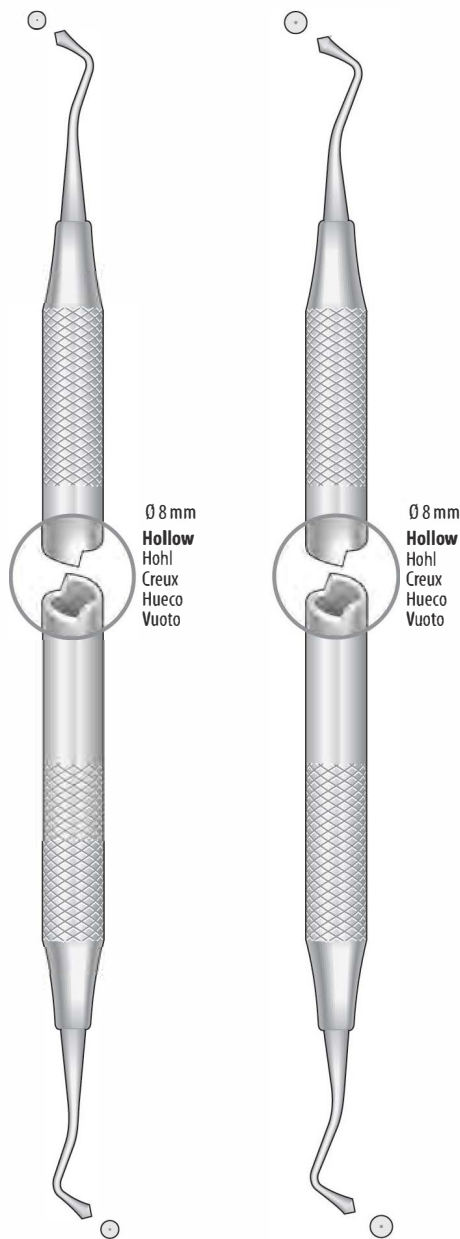

Ø 8 mm
Hollow
 Hohl
 Creux
 Hueco
 Vuoto

Ø 8 mm
Hollow
 Hohl
 Creux
 Hueco
 Vuoto

WESTCOTT
 wi-11543

WESTCOTT
 11544

WOODSON

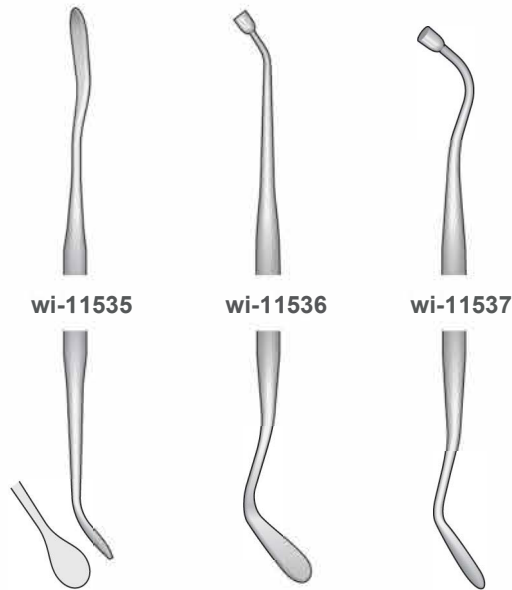

wi-11535

wi-11536

wi-11537

LADMORE

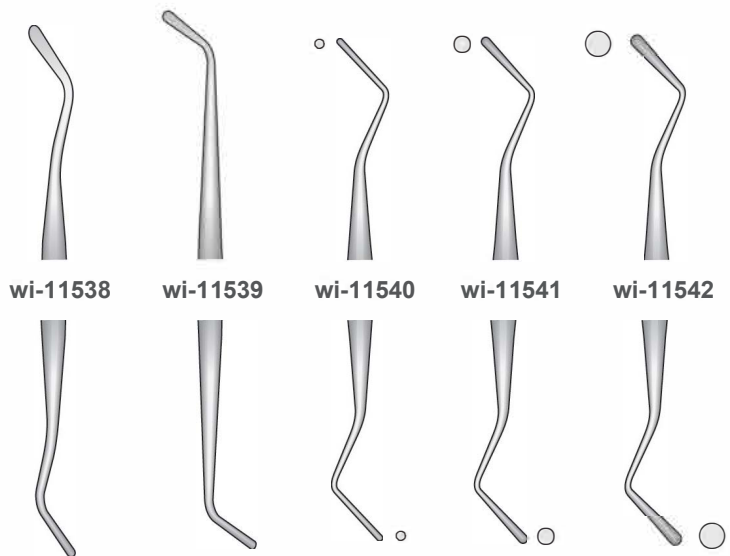

wi-11538

wi-11539

wi-11540

wi-11541

wi-11542



Füllungsinstrumente
 Filling Instruments
 Strumenti per otturazione
 Instrumentos para obturación
 Instruments pour obturation

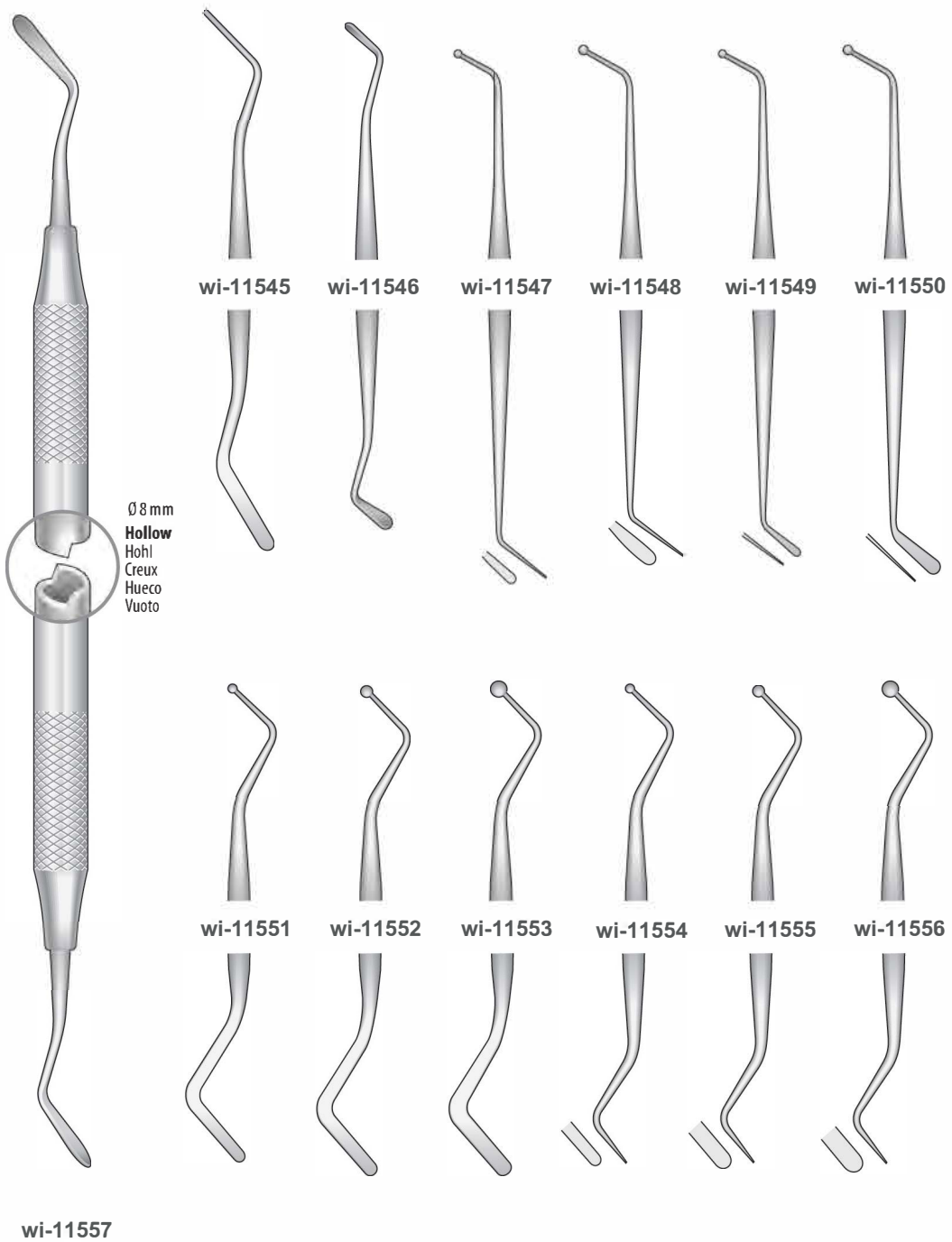



Kofferdam Instrumente
 Rubber-Dam Instruments
 Strumenti per diga
 Instrumentos para dique de goma
 Instruments pour digue de caoutchouc

Kofferdam-Klammern
 Rubber-Dam Clamps
 Uncini per diga
 Clamps para diques
 Crampons pour digue



IVORY
wi-11558
 # 26



IVORY
wi-11559
 # 27



IVORY
wi-11560
 # 28



IVORY
wi-11561
 # 29



IVORY
wi-11562
 # 30



IVORY
wi-115623
 # 31



IVORY
wi-11564
 # 51



IVORY
wi-11565
 # 60

Kofferdam-Rahmen
 Rubber-Dam Frames
 Telaio per diga
 Cuadro para diques
 Cadre à digue

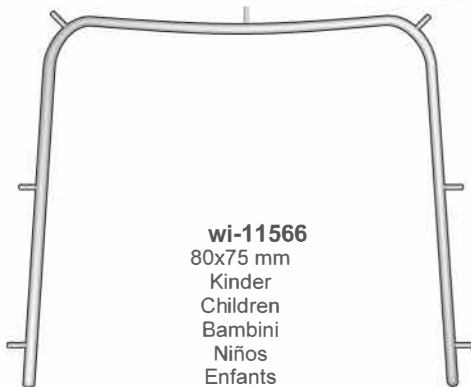

wi-11566
 80x75 mm
 Kinder
 Children
 Bambini
 Niños
 Enfants

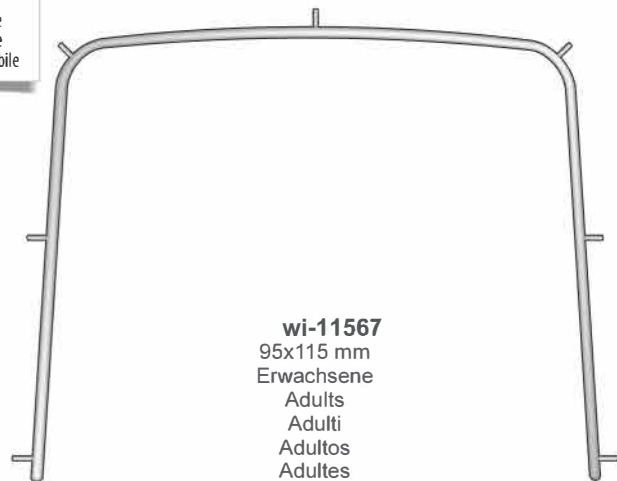

wi-11567
 95x115 mm
 Erwachsene
 Adults
 Adulti
 Adultos
 Adultes



Saugkanülen
Suction Tubes
Cannule per aspirazione
Cánulas de aspiración
Canules d'aspiration

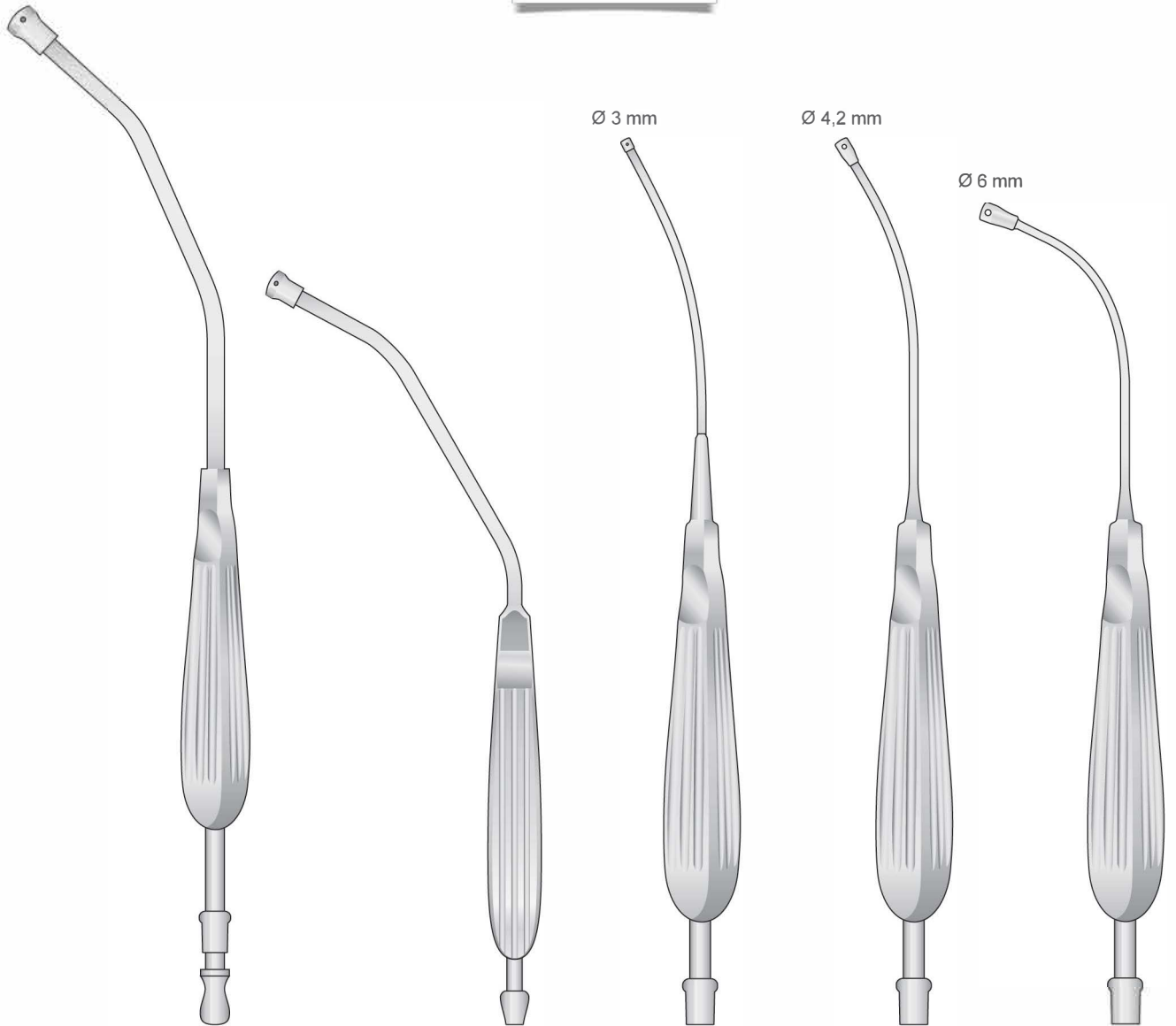

YANKAUER
wi-11568
310 mm

BABY-YANKAUER
wi-11569
200 mm

ANDREWS-PYNCHON
wi-11570
250 mm

ANDREWS-PYNCHON
wi-11571
250 mm

ANDREWS-PYNCHON
wi-11572
230 mm



Saugkanülen
Suction Tubes
Cannule per aspirazione
Cánulas de aspiración
Canules d'aspiration

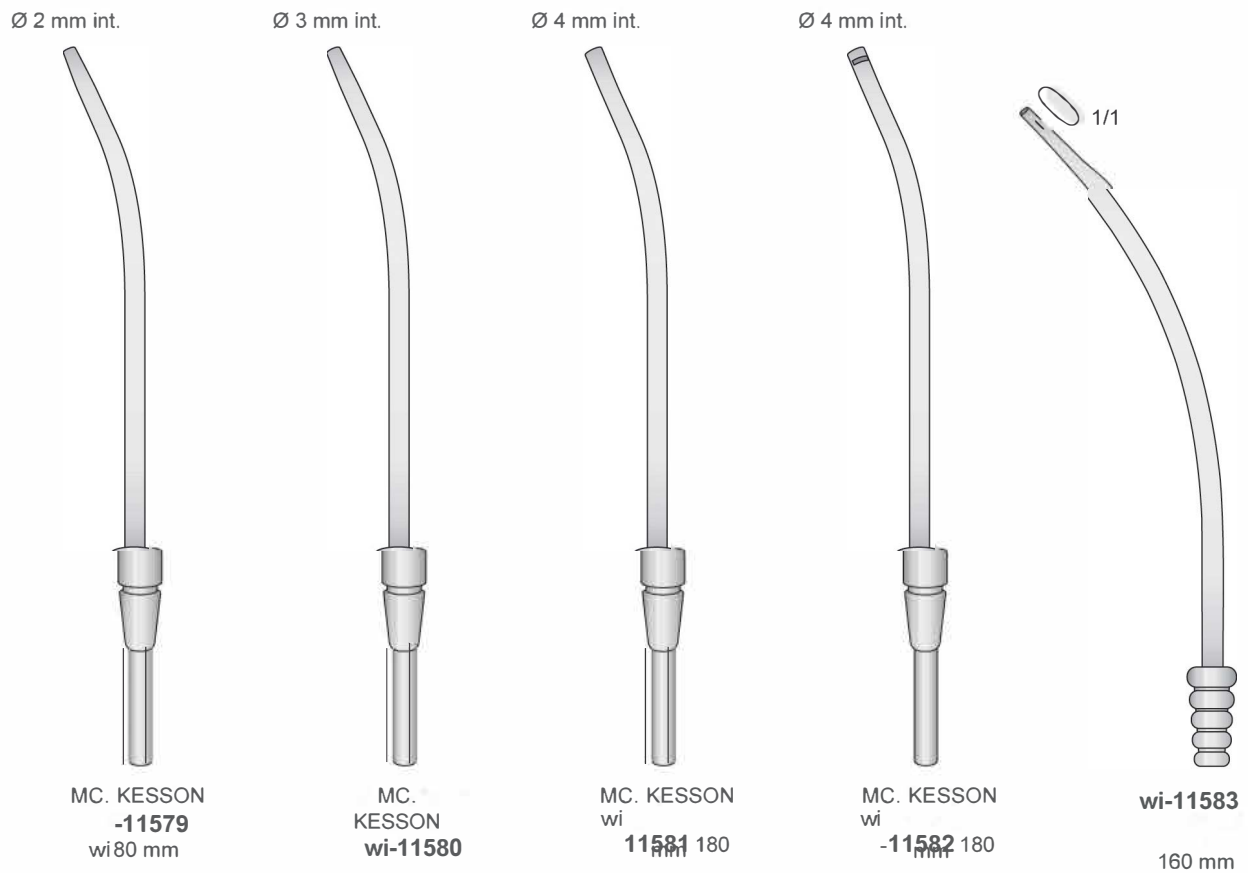
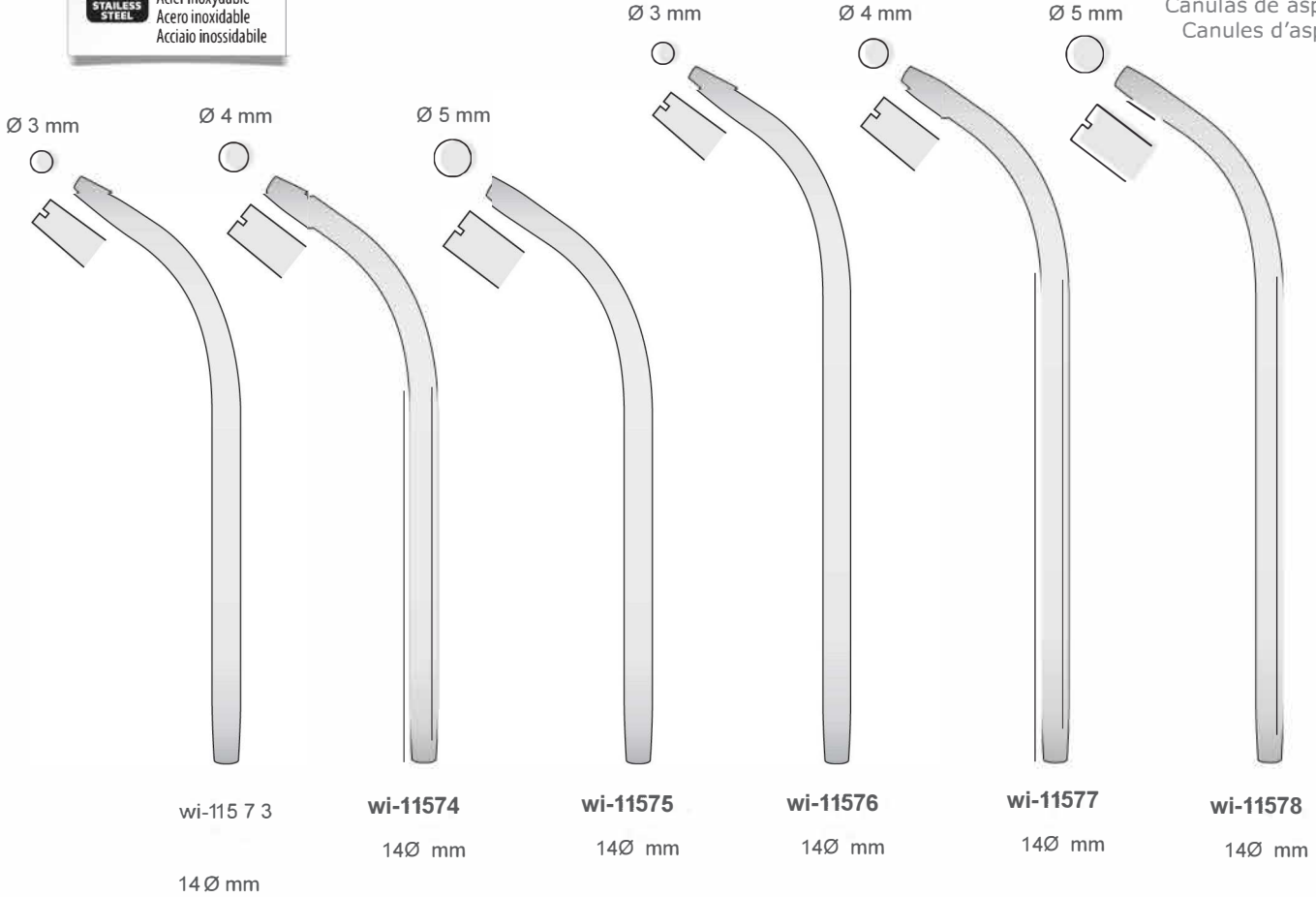



Saugkanülen
Suction Tubes
Cannule per aspirazione
Cánulas de aspiración
Canules d'aspiration



Stainless Steel
Rostfreier Stahl
Acier inoxydable
Acero inoxidable
Acciaio inossidabile

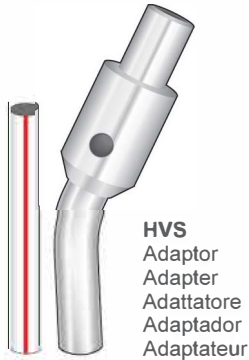

wi-11589
Connection piece for suction
75 mm - 100% Stainless Steel

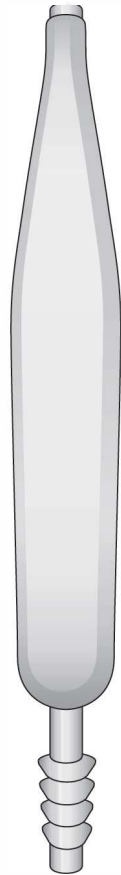

COUPLAND
wi-11588
150 mm

Ø 1 mm Ø 1,5 mm Ø 2,5 mm Ø 3,5 mm int.

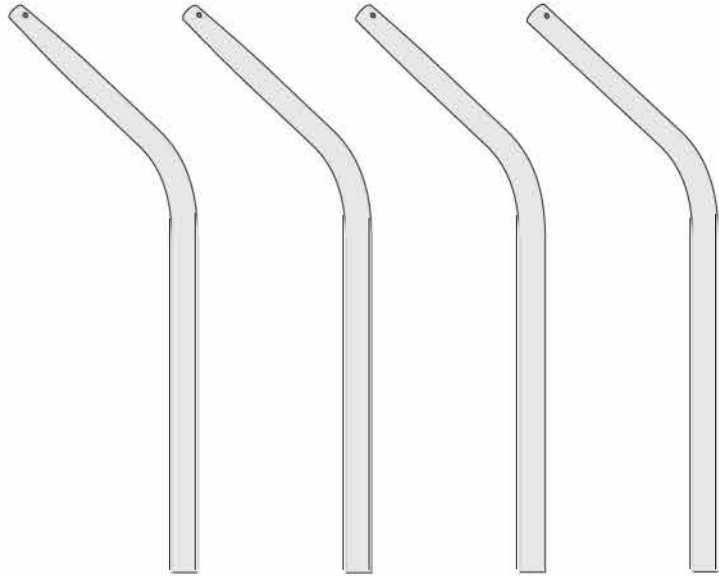

wi-11584 95 mm **wi-11585** 95 mm **wi-11586** 95 mm **wi-11587** 95 mm

COMPLETE SET
11593
(GF-01 + GF-02 + GF-03 + GF-04 + GF-05)
Griff + 4 Kanülen
Handle + 4 tubes
Manico + 4 cannule
Mango + 4 cánulas
Manche + 4 canules



GF-271
56 mm

Adaptor
Adapter
Adattatore
Adaptador
Adaptateur

Ø Ext. 6,0 mm
Ø Int. 4,5 mm

Autoclavable Tubing

Schlauch - Silikon
Flexible Tube - Silicone
Raccordo in silicone per cannule
Tubo flexible de silicona
Tuyau - Silicone

wi-11592
2 m

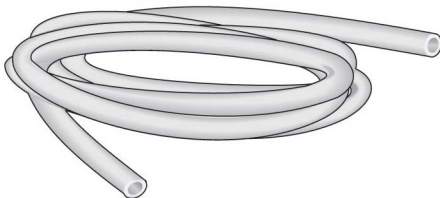

wi-11590
B1 Byrd
Self-Cleaning
Aspirator

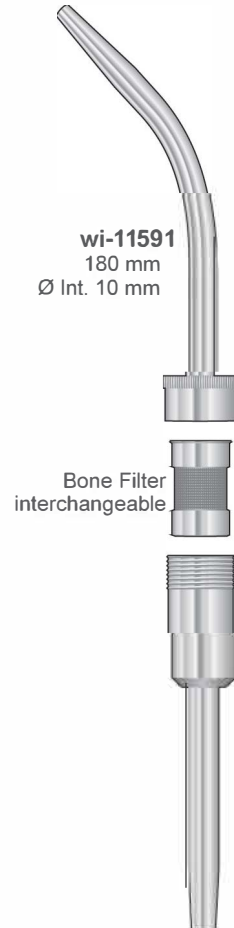

wi-11591
180 mm
Ø Int. 10 mm

Bone Filter
interchangeable



Saugkanülen
Suction Tubes
Cannule per aspirazione
Cánulas de aspiración
Canules d'aspiration

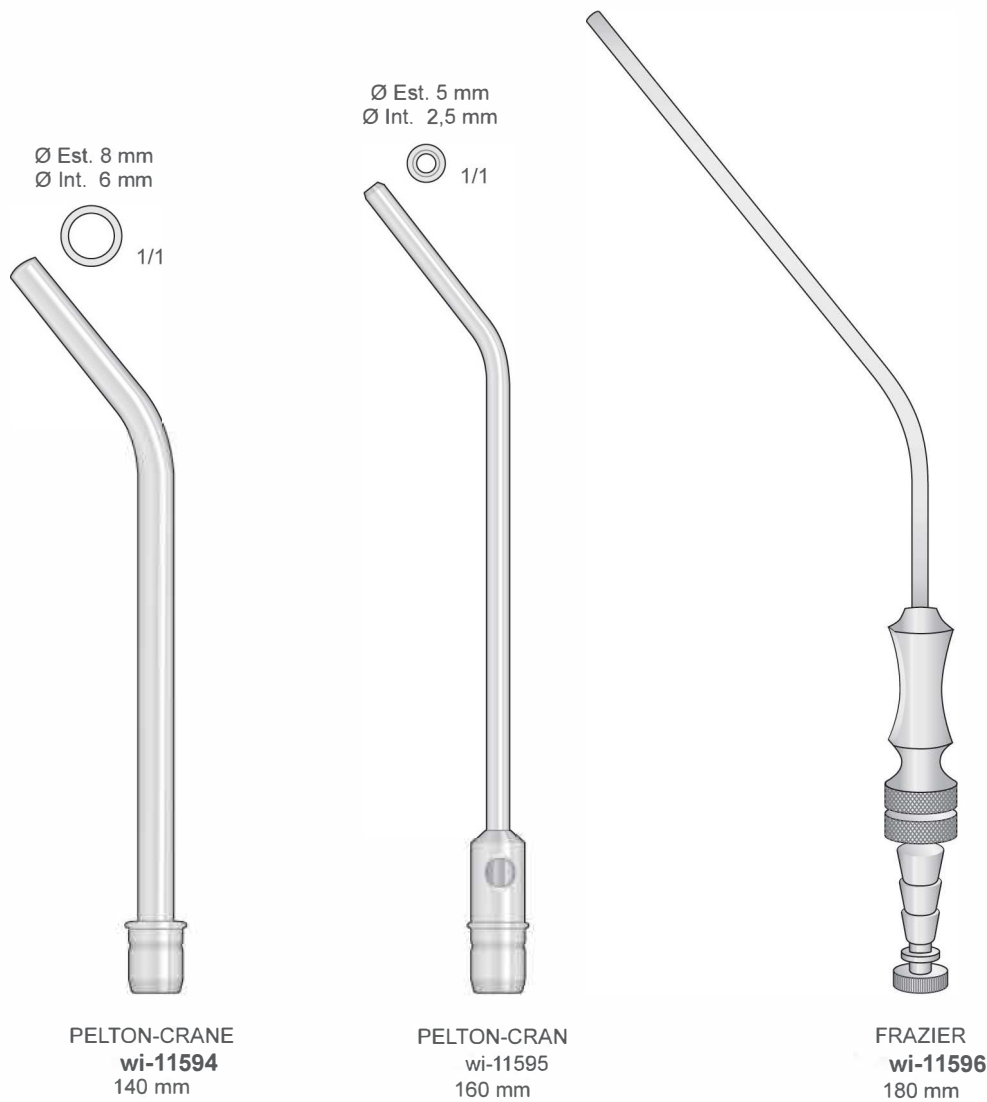



Saugkanülen
Suction Tubes
Cannule per aspirazione
Cánulas de aspiración
Canules d'aspiration



Flexible
Flexibel
Flexible
Flexible
Flessibile

Ø 3 mm

WERTHEIMER
wi-11597
160 mm



FRAZIER
wi-11598
160 mm

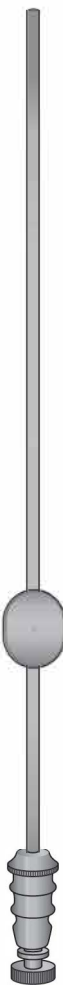

Flexible
Flexibel
Flexible
Flexible
Flessibile

Ø 3 mm

FRAZIER
wi-11599
200 mm

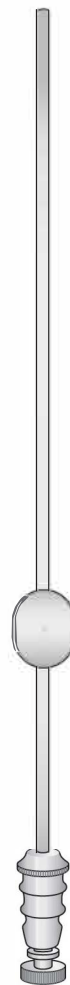

WERTHEIMER
wi-11600
200 mm



ADSON
wi-11601 ch. 12 Ø 4 mm
wi-11602 ch. 15 Ø 5 mm 210 mm



Kanülenreinigungs-Bürsten
 Cleaning brush for Tubes
 Scovolini per pulizia cannule
 Cepillo para limpiar cánulas
 Brosse de nettoyage pour canules



Bürsten
 Brush
 Spazzola
 Cepillo
 Brosse

Autoklav
 Autoclavable
 Autoclavabile
 Autoclave
 Autoclave

wi-11603
 4 x 11 cm

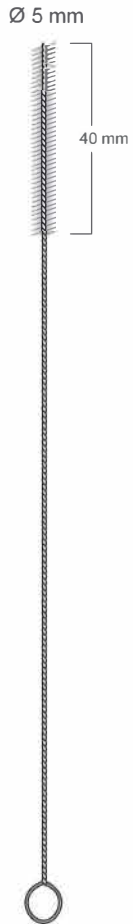

wi-11604
 235 mm

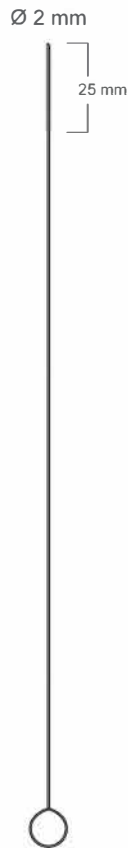

wi-11605
 215 mm



wi-11606
 300 mm

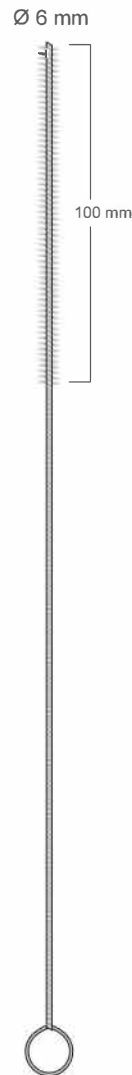

wi-11607
 300 mm

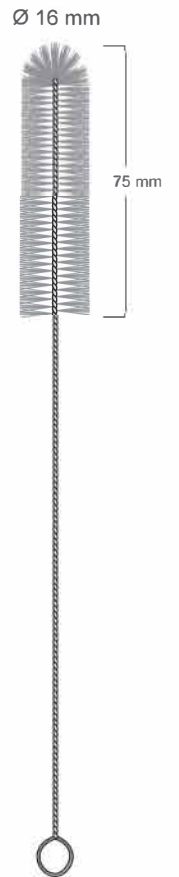

wi-11608
 220 mm



Instrumente für Laboratorium
Instruments for laboratory
Strumenti da laboratorio
Instrumentos para laboratorio
Instruments pour laboratoire

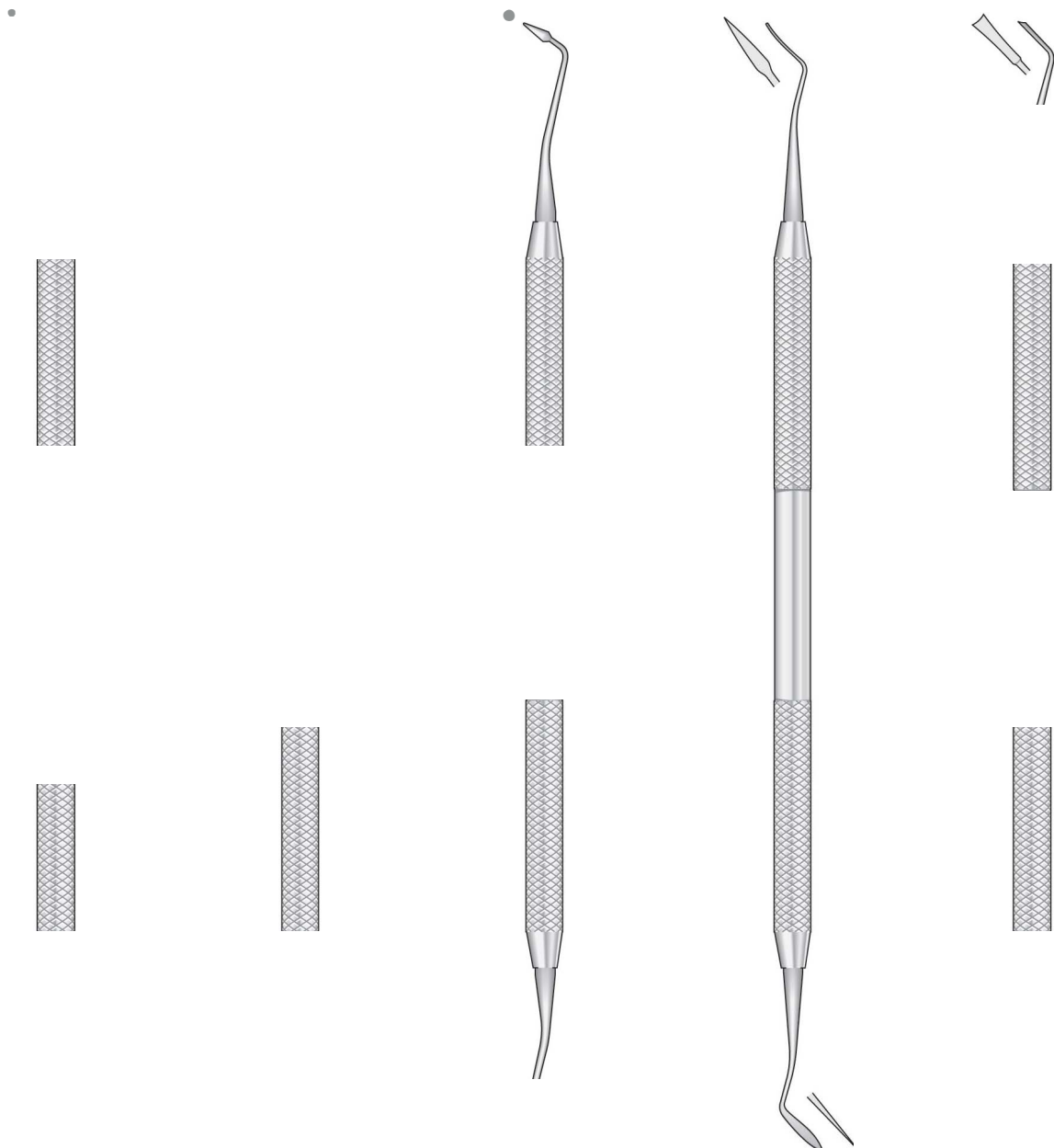

P.K. THOMAS
wi-11609
165 mm

P.K. THOMAS
wi-11610
165 mm

P.K. THOMAS
wi-11611
165 mm

P.K. THOMAS
wi-11612
165 mm

P.K. THOMAS
wi-11613
165 mm



Instrumente für Laboratorium
 Instruments for laboratory
 Strumenti da laboratorio
 Instrumentos para laboratorio
 Instruments pour laboratoire

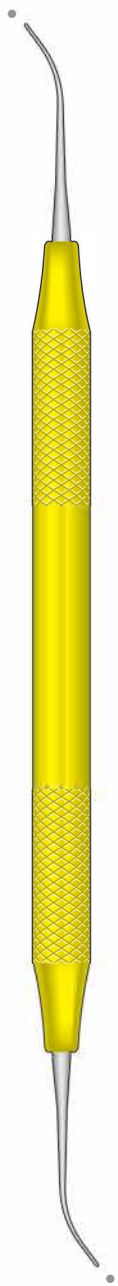

P.K. THOMAS
wi-11614
 165 mm

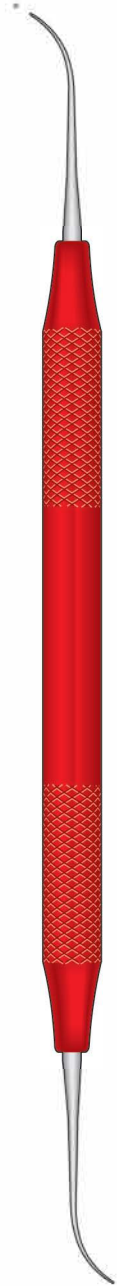

P.K. THOMAS
wi-11615
 165 mm

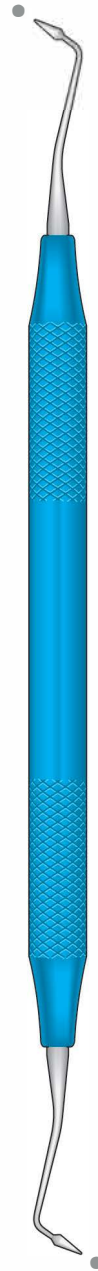

P.K. THOMAS
wi-11616
 165 mm

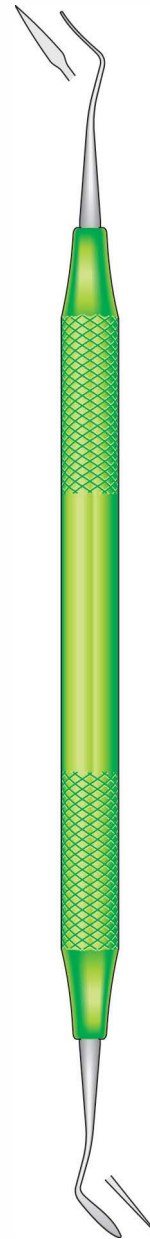

P.K. THOMAS
wi-11617
 165 mm



Ø 8 mm
Hollow
 Hohl
 Creux
 Hueco
 Vuoto

P.K. THOMAS
wi-11618
 165 mm



Modellierinstrumente für Keramik
 Ceramic Sculpturing Instruments
 Strumenti per ceramica
 Instrumentos para modelar la cerámica
 Instruments à modeler la céramique

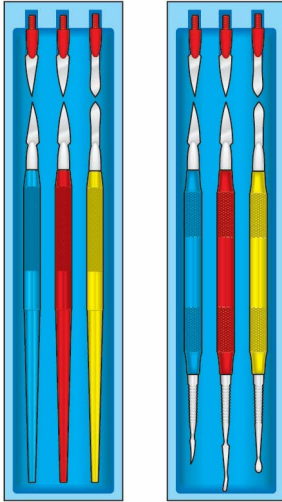

Biegsam - Flexible
 Flessibili - Flexibles
 Flexibles

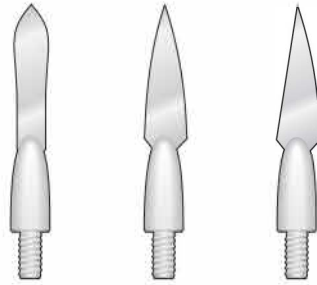

wi-11619 wi-11620 wi-11621

Superbiegsam - Superflexible
 Superflessibili - Superflexibles
 Superflexibles

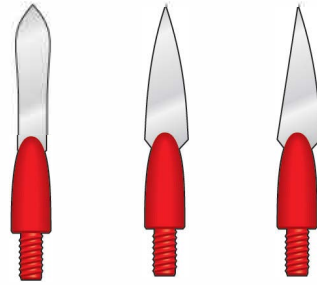

wi-11622 wi-11623 wi-11624



wi-11624A



wi-11624B

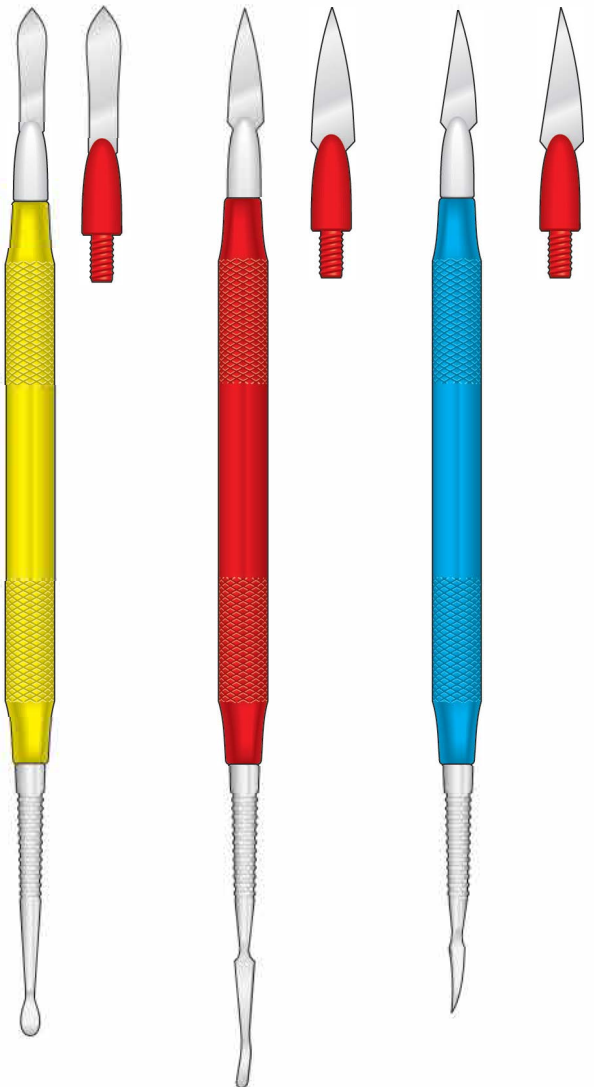



Instrumente für Laboratorium
 Instruments for laboratory
 Strumenti da laboratorio
 Instrumentos para laboratorio
 Instruments pour laboratoire

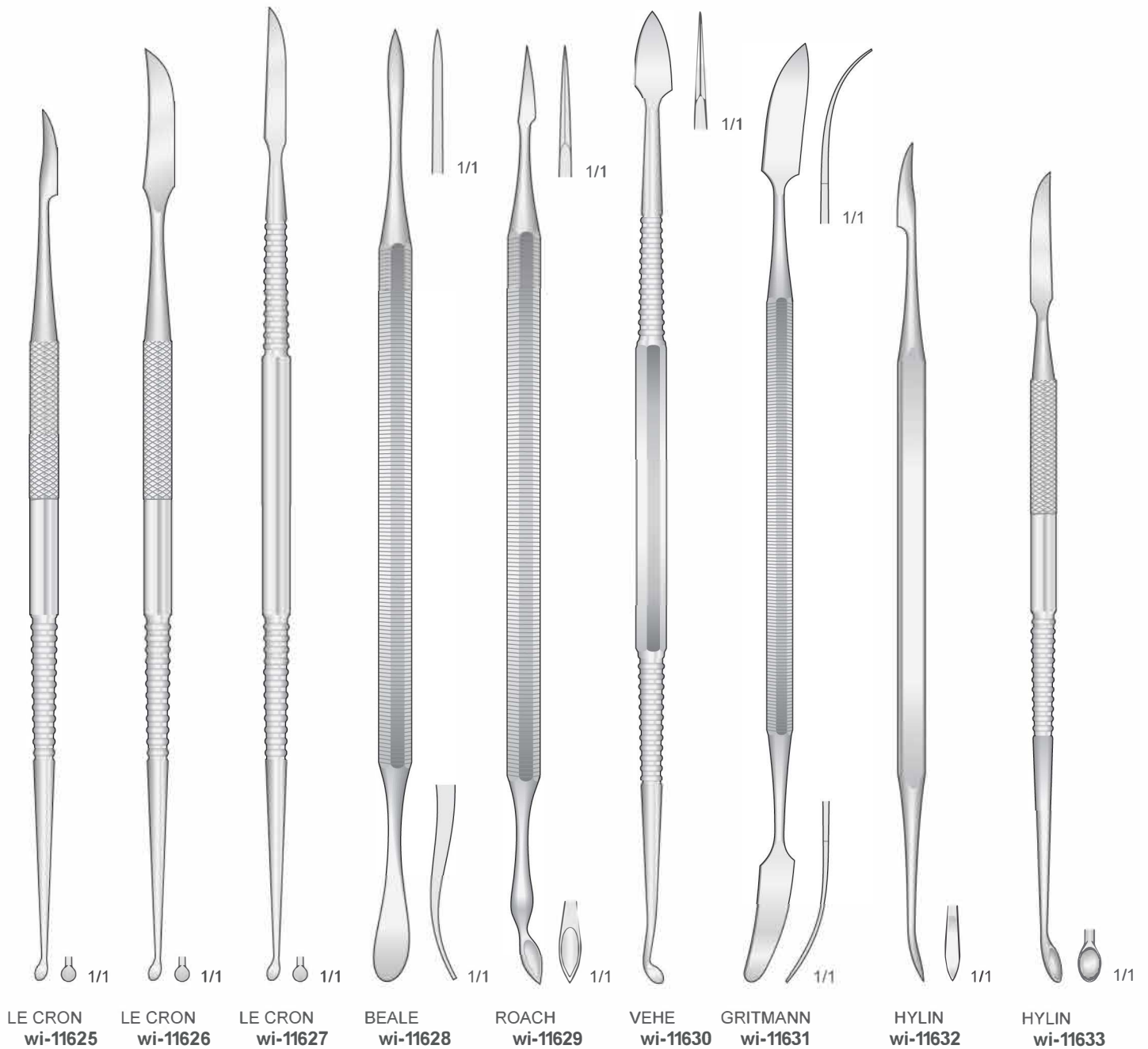



Instrumente für Laboratorium
 Instruments for laboratory
 Strumenti da laboratorio
 Instrumentos para laboratorio
 Instruments pour laboratoire

Gipsschneidezange
 Plaster cutting pliers
 Cesويا taglia gesso
 Alicates para cortar yeso
 Pince à couper le piâtre

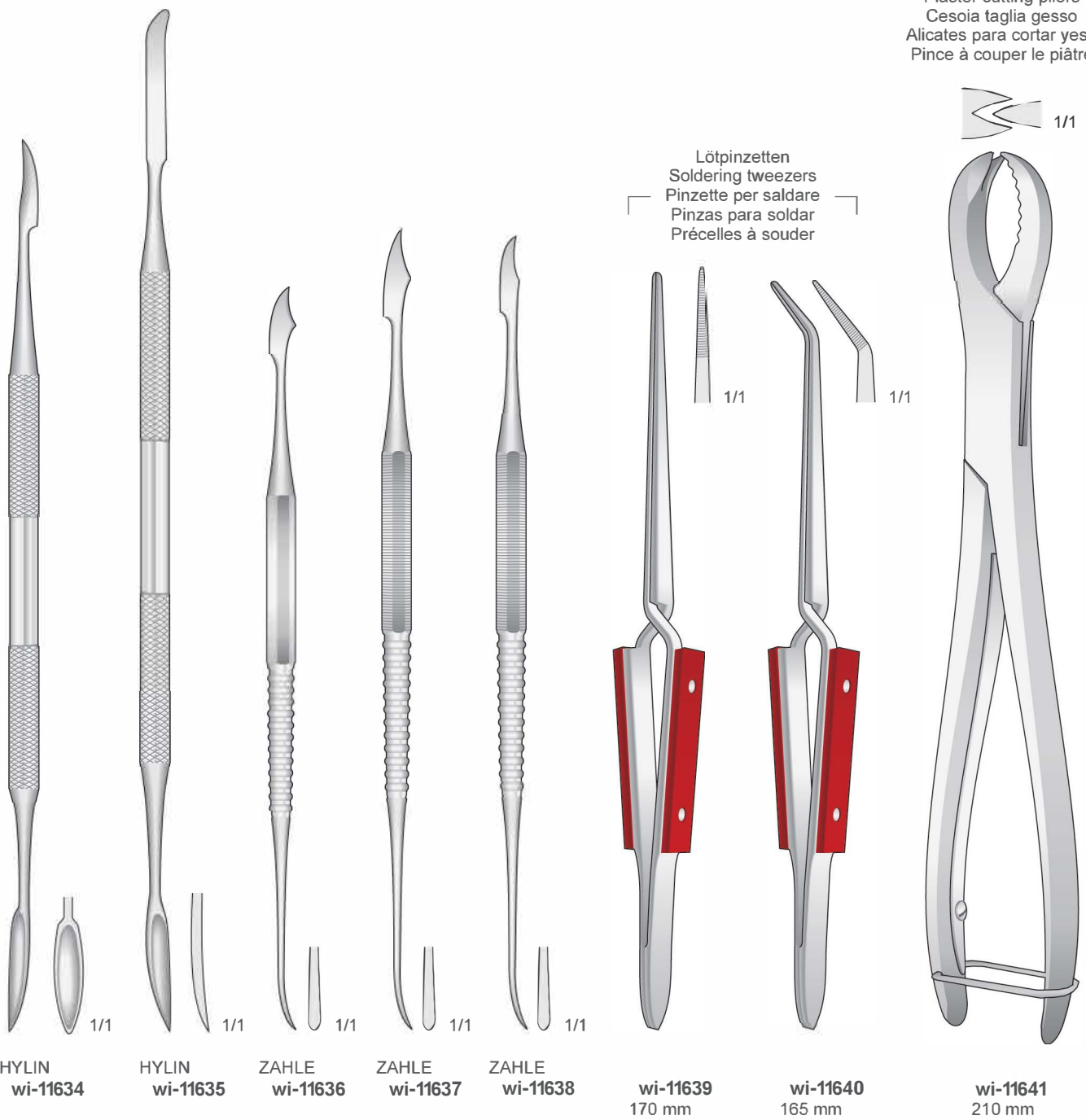

HYLIN
wi-11634

HYLIN
wi-11635

ZAHLE
wi-11636

ZAHLE
wi-11637

ZAHLE
wi-11638

wi-11639
170 mm

wi-11640
165 mm

wi-11641
210 mm

Lötpinzetten
 Soldering tweezers
 Pinzette per saldare
 Pinzas para soldar
 Précelles à souder



Inquiry now Today!

 +92 306 7524947

 +92 52 3505094

 info@snazanintl.com

New Adalat Garha
Sialkot 51310, PAKISTAN

www.snazanintl.com