



SNAZAN
INTERNATIONAL

High Quality Surgical Instruments



Email: info@snazanintl.com

WhatsApp: +92 306 7524947

Website: www.snazanintl.com



01-101
 TROEMNER
 Size: 245 mm

1/2



01-102
 DEJERINE
 Size: 200 mm

1/2



01-103
 DEJERINE
 With Needle
 Size: 210 mm

1/2



01-104
 TAYLOR
 Size: 195 mm

1/2



01-105
 BERLINER
 Size: 200 mm

1/2

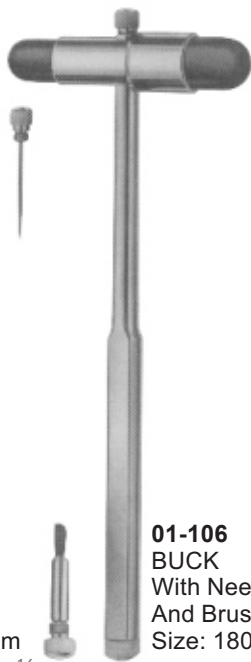

01-106
 BUCK
 With Needle
 And Brush
 Size: 180 mm

1/2



01-107
 RABINER
 With Needle
 And Brush
 Size: 255 mm

1/2



01-108
 ALY
 Size: 190 mm

1/2



01-109
 WARTENBERG
 Pinwheel For
 Neurological
 Examination
 Size: 185 mm

1/2



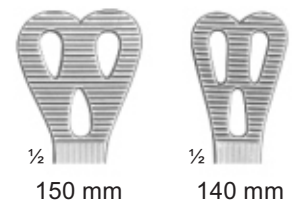
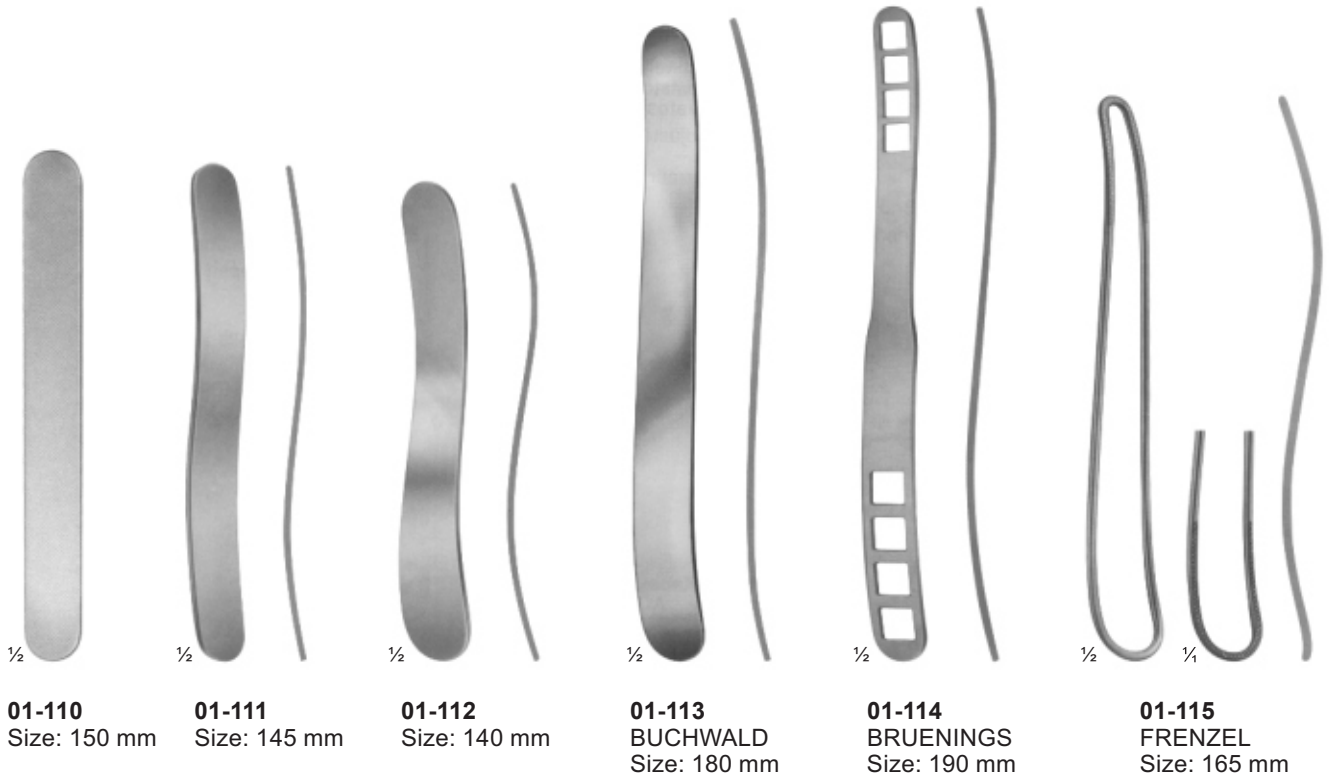



1/2

01-121
HEISTER
 Mouth Gag
 Size: 130 mm



1/2

01-122
FERGUSSON-ACKLAND
 Mouth Gag
 Size: 145 mm



1/2

01-123
DENHARDT
 Mouth Gag With Silicon
 Inserts, Interchangeable
 Size: 125 mm



1/2

01-124
ROSER KONIG
 Mouth Gag
 Size: 160 mm,
 185 mm



1/2

01-125
YOUNG
 Size: 165 mm



1/4
 1 Pair Of
 Rubber Pads

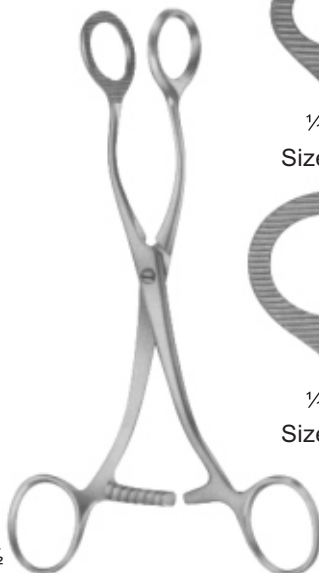

1/2

01-126
COLLIN
 Size: 160 mm, 170 mm



1/4
 Size: 160 mm



1/4
 Size: 170 mm

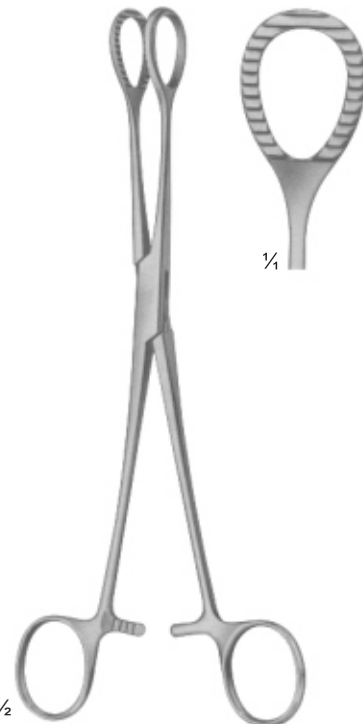

1/2

01-127
HEYWOOD-SMITH modif.
 Size: 215 mm





01-146
Boley



Metal: **01-147**
 Wax : **01-148**
 Double Side Marking
 Iwanson



01-149
CAROLL
 Size: 140 mm



01-150
TOWNLEY
 Size: 100 mm



01-151
BERTILLON
 Caliper For Measuring The Head
 Size: 320 mm



01-152
CASTROVIEJO
 Caliper



01-153
MOLTGEN
 Goniometer

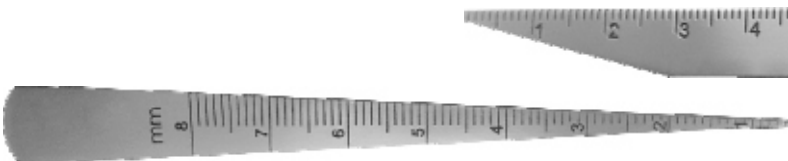

01-155
Wedge Ruler
 Size: 150 mm

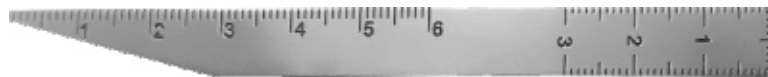

01-154
Measuring Scale
 Size: 500 mm





$\frac{1}{4}$
01-156-165
Fig. 1 - 10



01-156
Fig. 1
30mm



01-157
Fig. 2
36mm



01-158
Fig. 3
40mm



01-159
Fig. 4
45mm



01-160
Fig. 5
50mm



$\frac{1}{4}$
01-161
Fig. 6
27mm



01-162
Fig. 7
35mm



01-163
Fig. 8
40mm



01-164
Fig. 9
47mm



01-165
Fig. 10
50mm

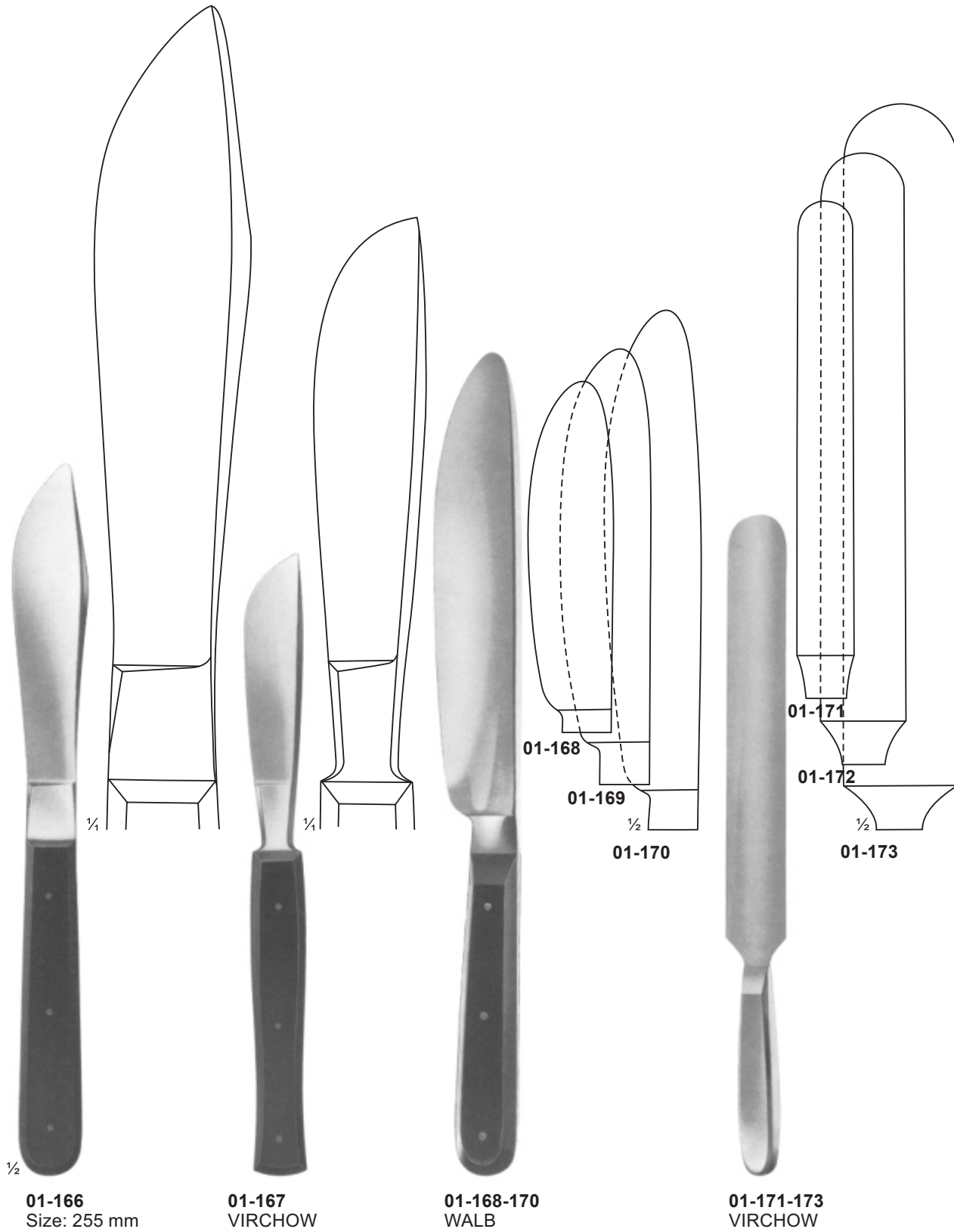

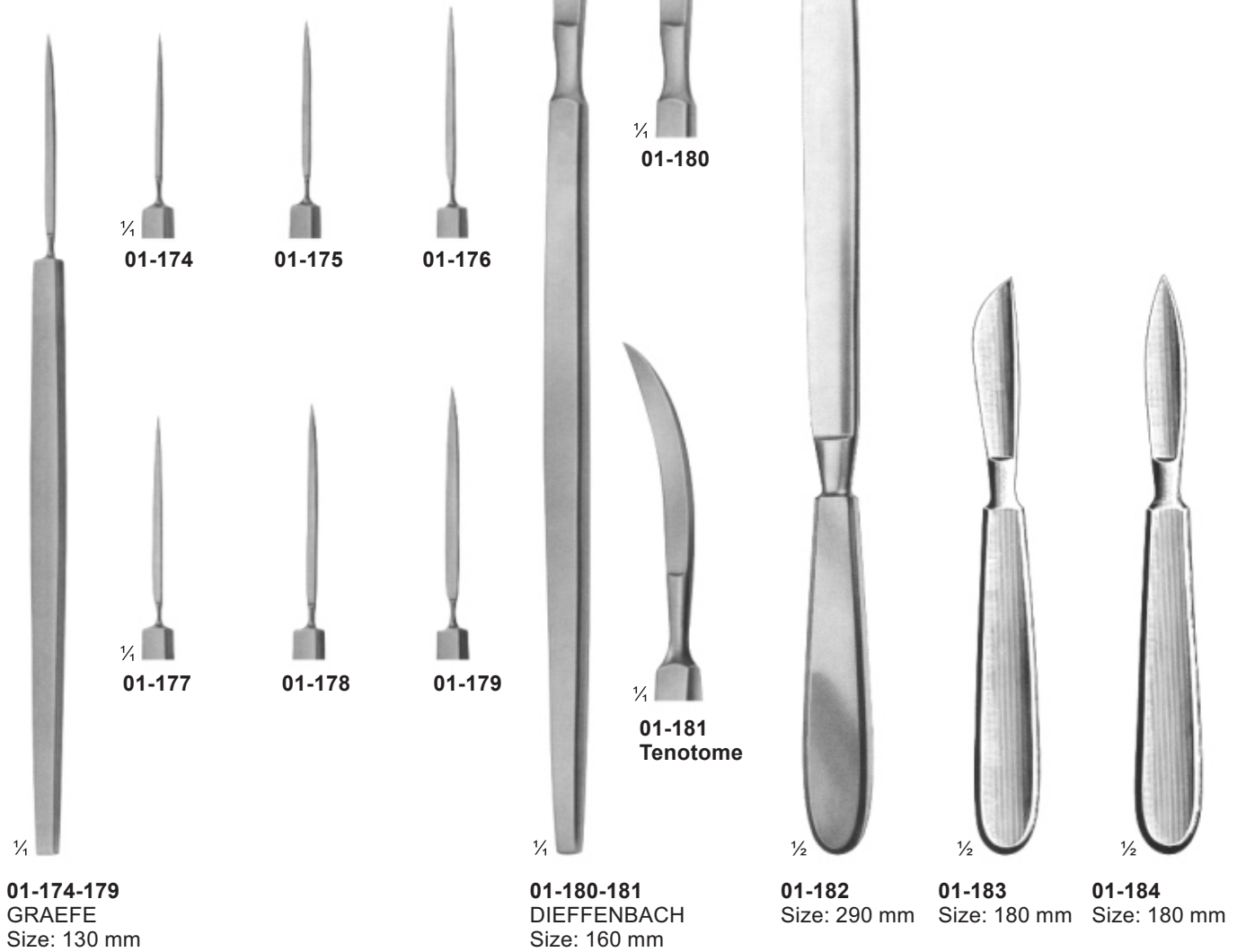

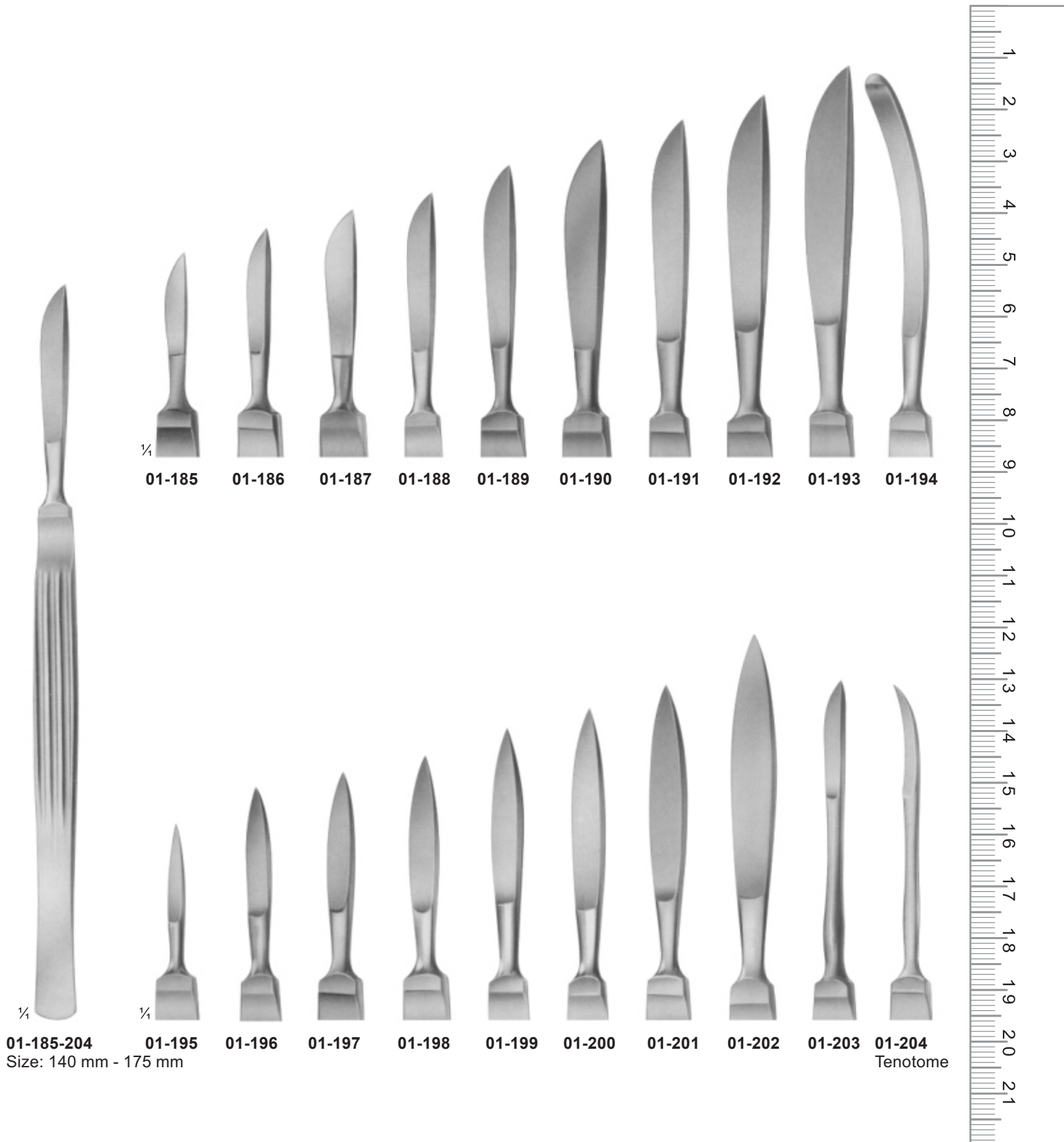



01-205 Size: 130 mm	01-209 CATLIN Size: 160 mm	01-210 LANGENBECK Size: 120 mm	01-211 Size: 110 mm	01-212 Size: 55 mm	01-213 Size: 70 mm	01-214 Size: 80 mm	01-215 Size: 195 mm
01-206 Size: 160 mm	Blade Length	Blade Length	Blade Length	Blade Length	Blade Length	Blade Length	Blade Length
01-207 Size: 190 mm	Amputating	Flap Knives	Interosseous	With Raspatory,	Wooden Handle	Metal Handle	Metal Handle
01-208 Size: 200 mm	Knives		Knives	Wooden Handle			
Blade Length							
Amputating Knives							

Cone Knives, Myomatome, Trigeminal & Tonsil Knives
Cone Messer, Myomatome, Trigeminus- & Tonsil Messer
 Cuchillos Del Cono Sur, Myomatome, Cuchillos Del Trigémينو Y Las Amígdalas

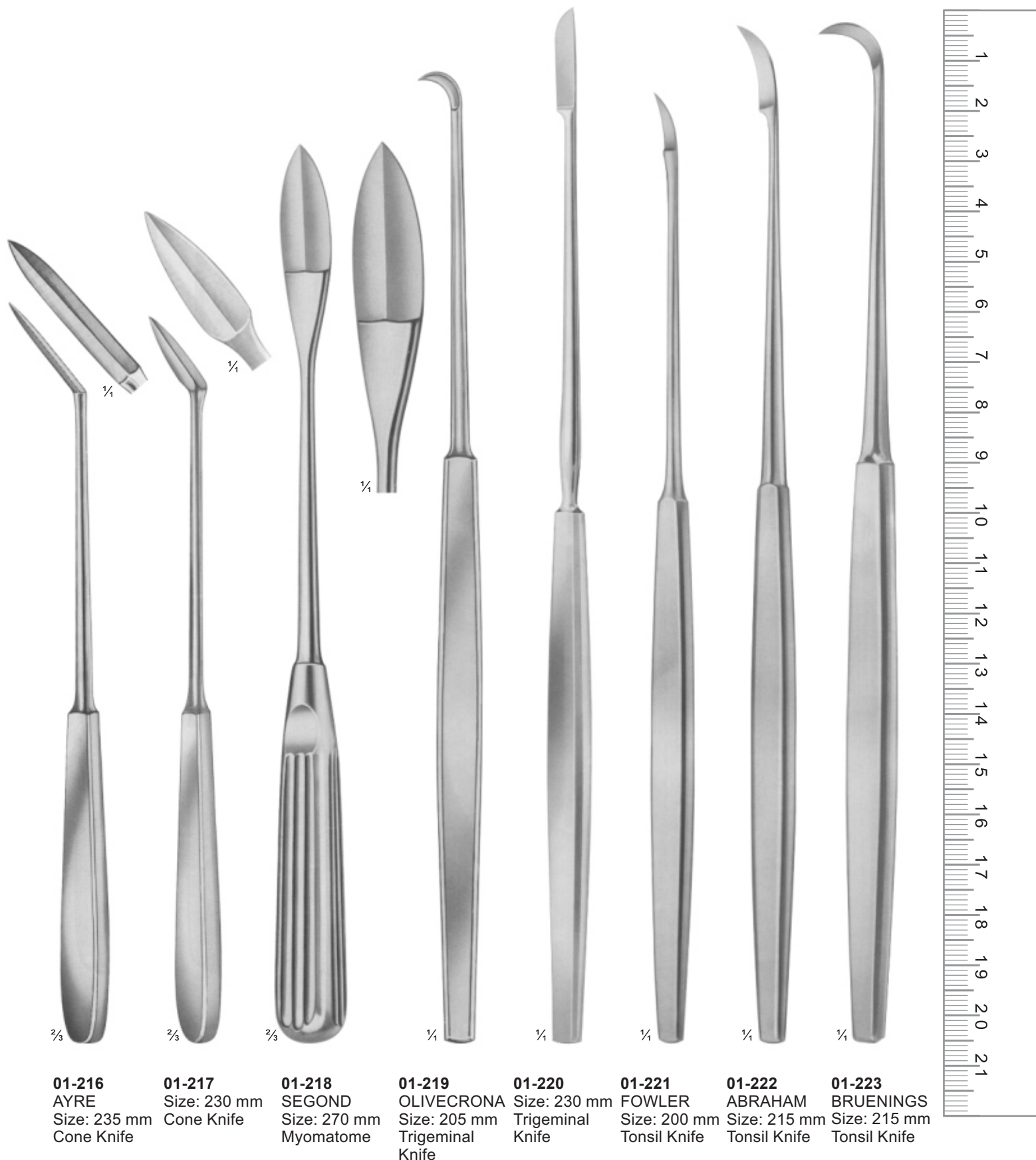

01-216
 AYRE
 Size: 235 mm
 Cone Knife

01-217
 Size: 230 mm
 Cone Knife

01-218
 SEGOND
 Size: 270 mm
 Myomatome

01-219
 OLIVECRONA
 Size: 205 mm
 Trigeminal
 Knife

01-220
 Size: 230 mm
 Trigeminal
 Knife

01-221
 FOWLER
 Size: 200 mm
 Tonsil Knife

01-222
 ABRAHAM
 Size: 215 mm
 Tonsil Knife

01-223
 BRUENINGS
 Size: 215 mm
 Tonsil Knife

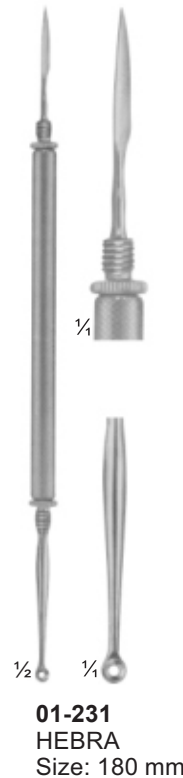
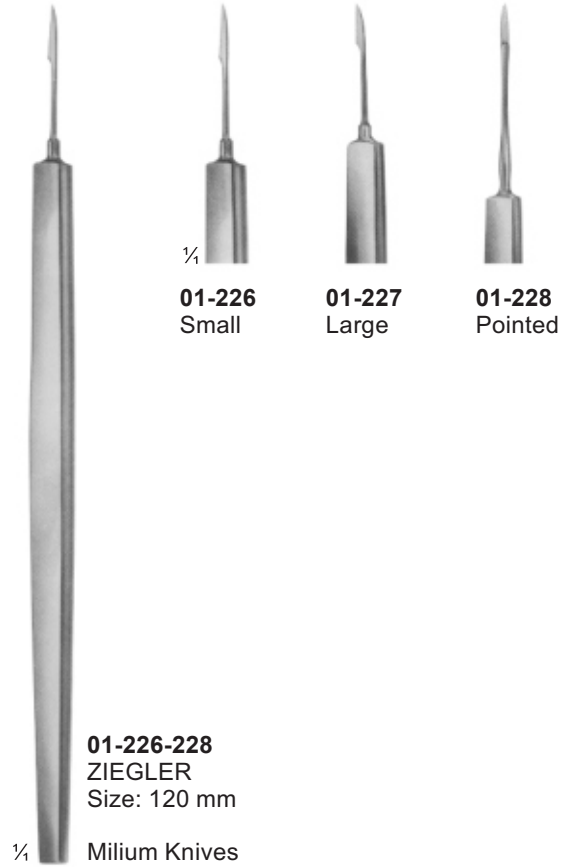
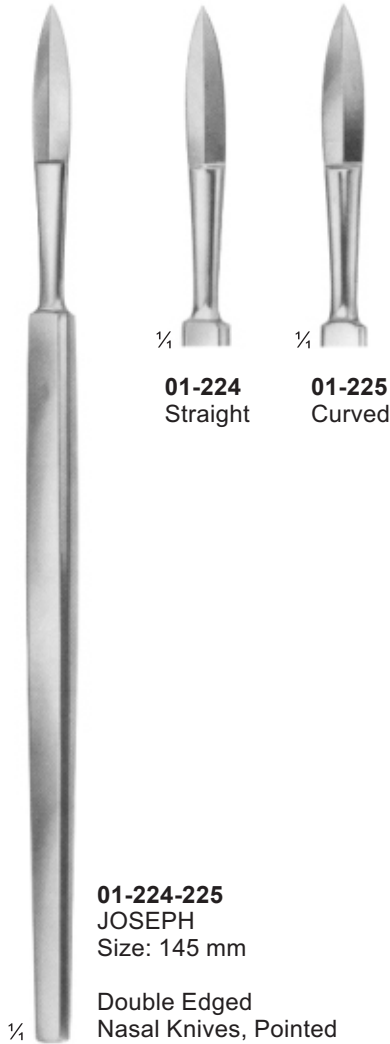

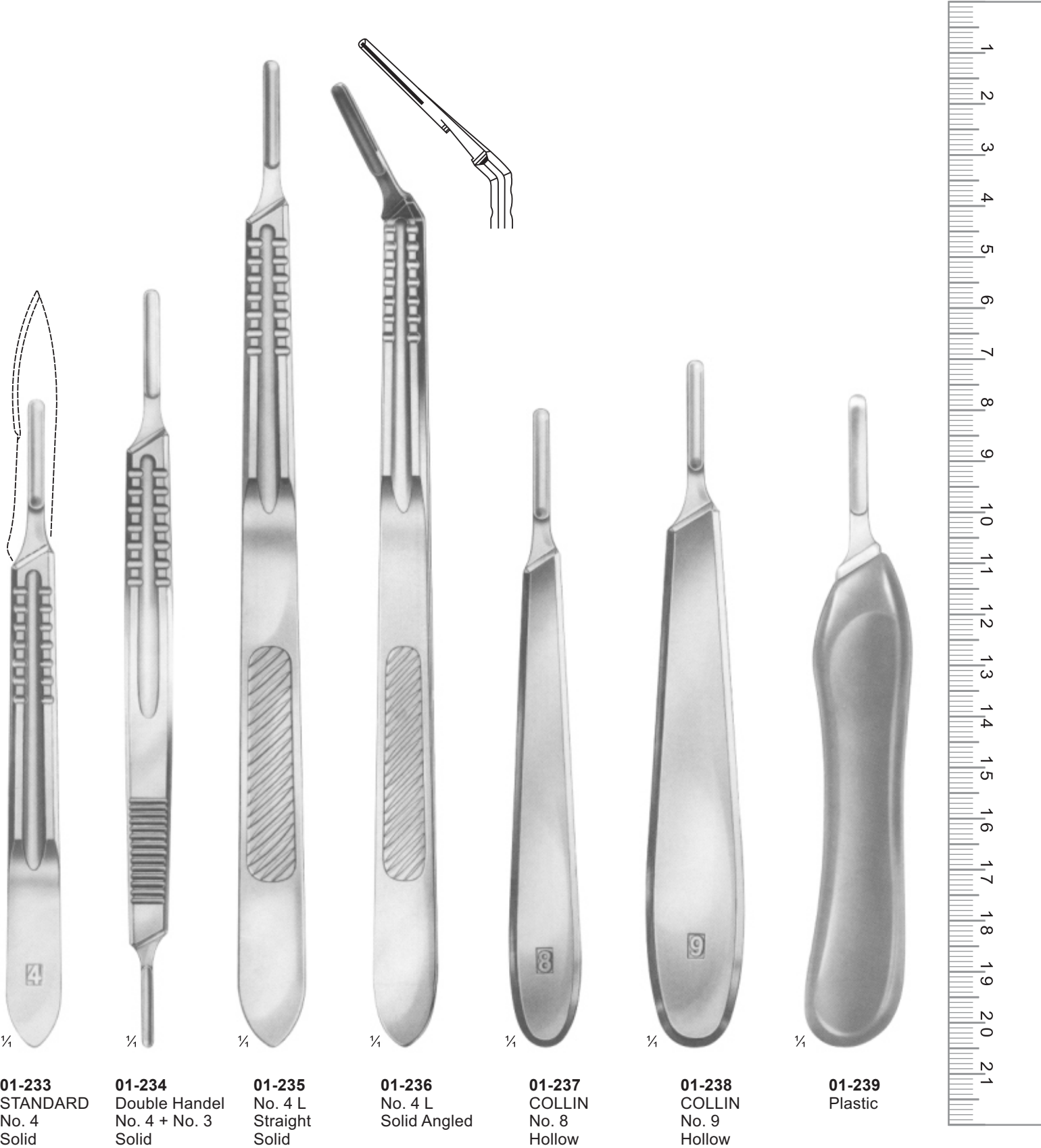

01-233
 STANDARD
 No. 4
 Solid

01-234
 Double Handel
 No. 4 + No. 3
 Solid

01-235
 No. 4 L
 Straight
 Solid

01-236
 No. 4 L
 Solid Angled

01-237
 COLLIN
 No. 8
 Hollow

01-238
 COLLIN
 No. 9
 Hollow

01-239
 Plastic

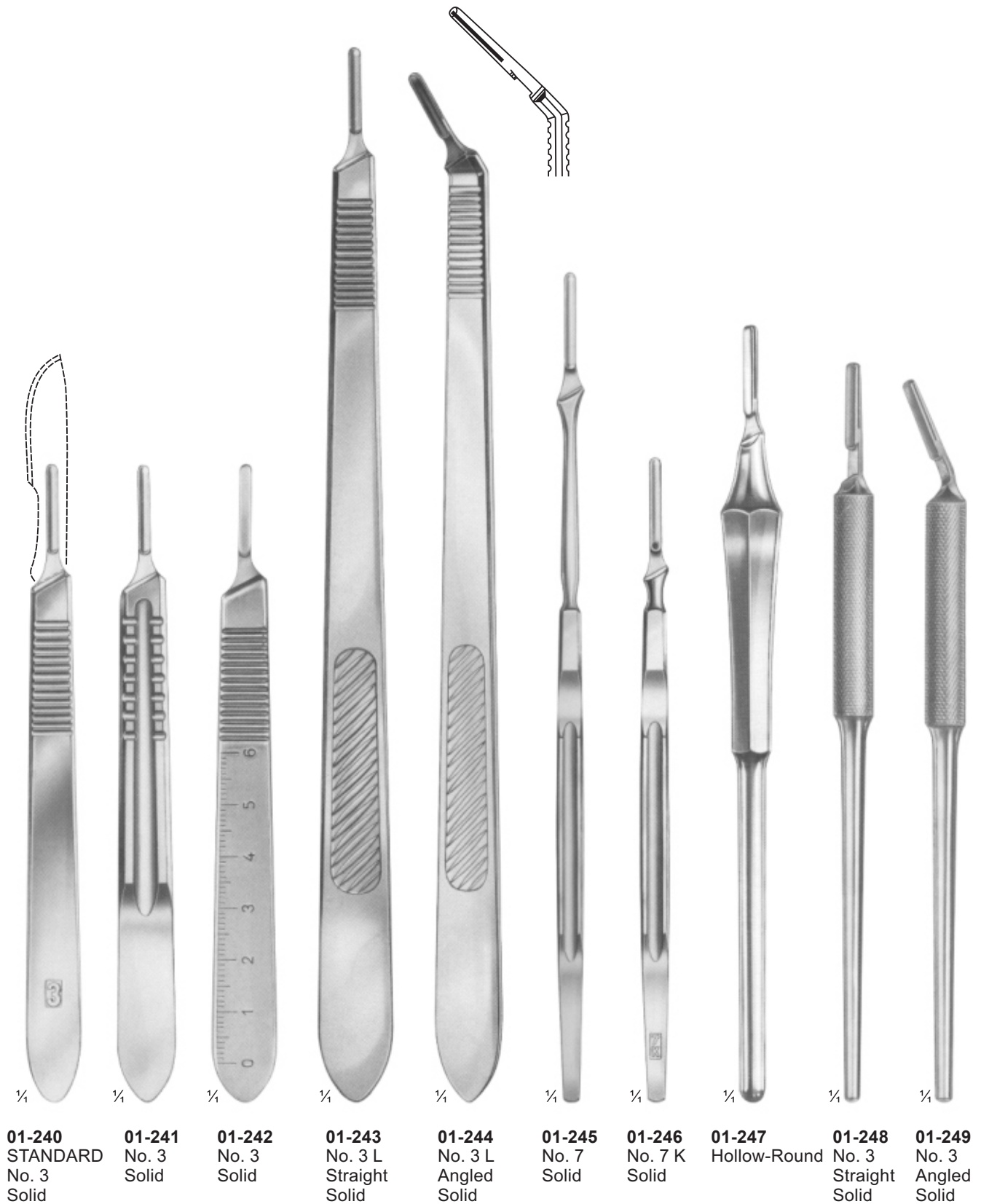

01-240 STANDARD No. 3 Solid	01-241 No. 3 Solid	01-242 No. 3 Solid	01-243 No. 3 L Straight Solid	01-244 No. 3 L Angled Solid	01-245 No. 7 Solid	01-246 No. 7 K Solid	01-247 Hollow-Round	01-248 No. 3 Straight Solid	01-249 No. 3 Angled Solid
---	---------------------------------	---------------------------------	---	---	---------------------------------	-----------------------------------	-------------------------------	---	---

Micro Scissors, "spring Type" Flat Handles
Micro Scissors, "spring Typ" Flache Griffe
Tijeras Micro, "tipo De Primavera" Flat Maneja

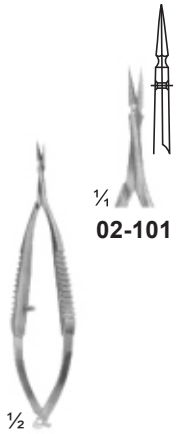

02-101-103
VANNAS
 Size: 85 mm



02-104-105
CASTROVIEJO
 Size: 95 mm

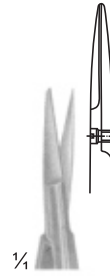

02-106
NOYES
 Size: 125 mm

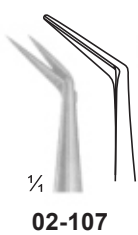

02-107 - 108
WECKER
 Eye Scissor
 Size: 110 mm

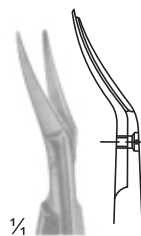
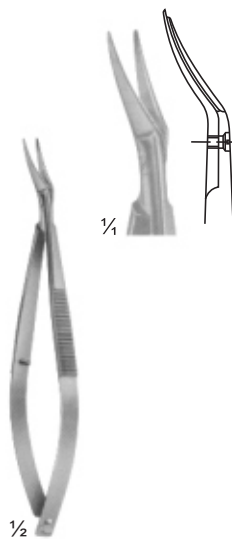

02-109
CASTROVIEJO
 Eye Scissor
 Size: 115 mm

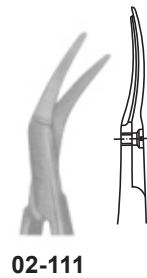
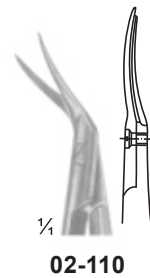

02-110- 111
CASTROVIEJO
 Eye Scissor
 Size: 110 mm



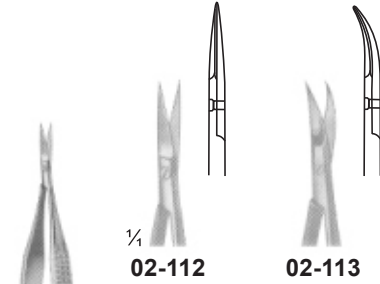

02-112 - 113
Size: 120 mm

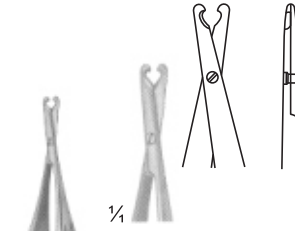

02-114
BIEMER
Vein Scissor
Size: 130 mm

02-115
Size: 160 mm

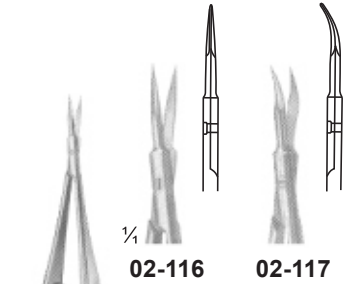

02-116 - 117
VANNAS
Size: 160 mm

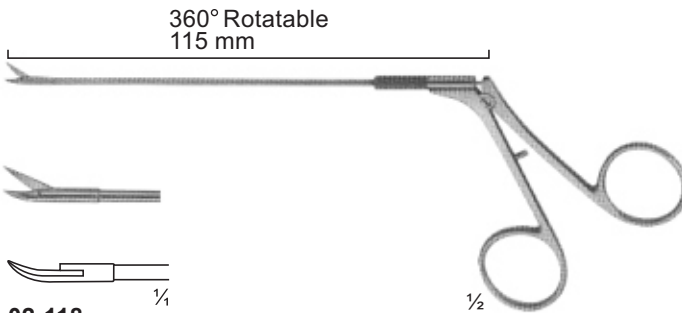

02-118
CASPAR
Micro Scissor Curved
Size: 115 mm

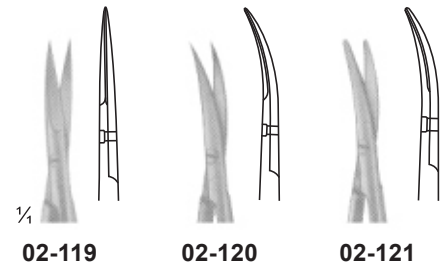

02-119- 121
Micro Dissecting Scissor
Size: 145 mm

Micro Scissors, "spring Type" Bayonet Shape
 Micro Scissors, "frühlings-typ" Shape-bajonett
 Tijeras Micro, "tipo De Primavera" Bayonet Forma

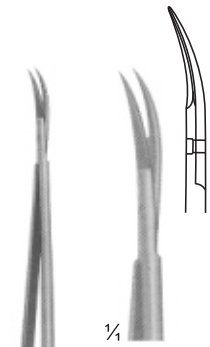

1/4

1/2

02-122
 YASARGIL
 Size: 245 mm



1/4

02-123



1/4

02-124



1/2

02-123 - 124
 Laterally Angled
 Size: 200 mm



1/2

02-125
 Laterally Angled
 Size: 190 mm

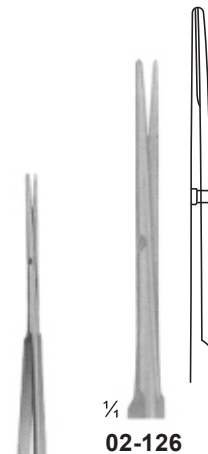

1/4

02-126

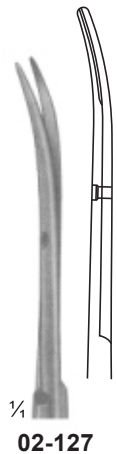

1/4

02-127



1/2

02-126 - 127
 YASARGIL
 Size: 225 mm

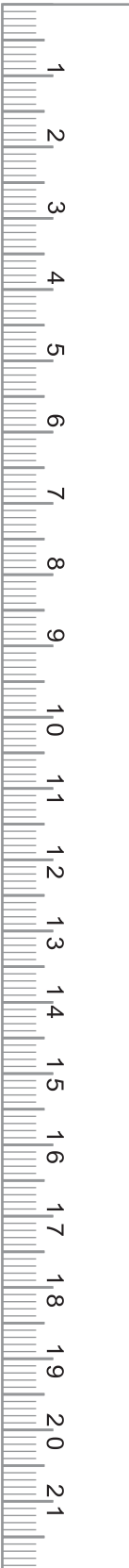

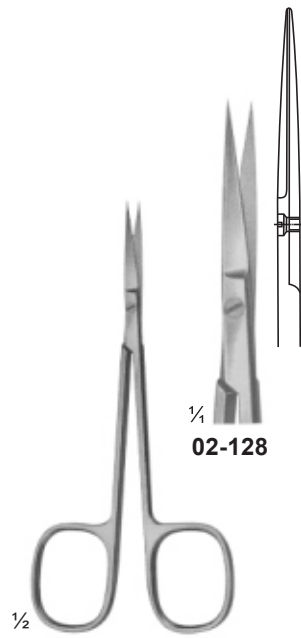

1/2
02-128

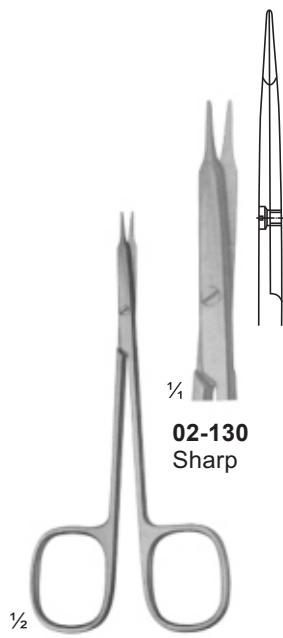
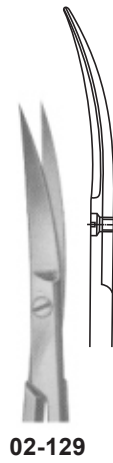

1/4
02-130
Sharp

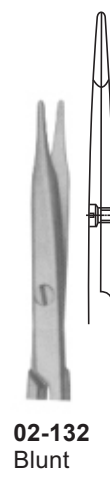
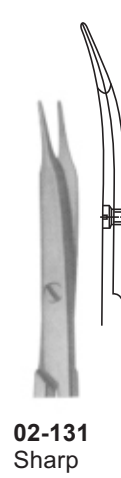

02-132
Blunt

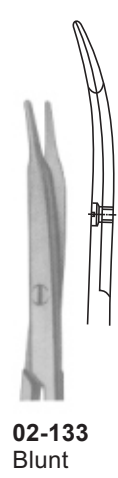

02-133
Blunt

02-128 - 129
Size: 120 mm

1/2
02-130 - 133
STEVENS
Dissecting Scissors
Size: 115 mm

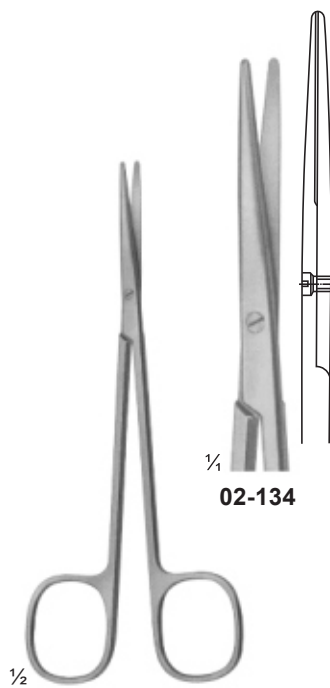

1/4
02-134

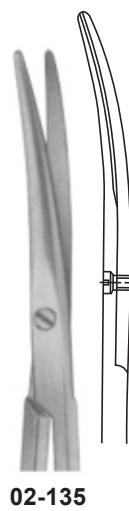

02-135

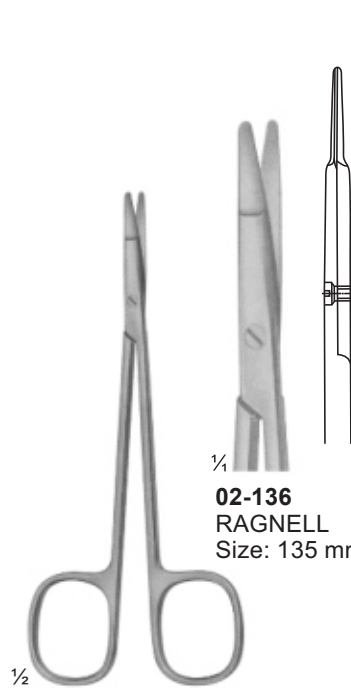

1/4
02-136
RAGNELL
Size: 135 mm

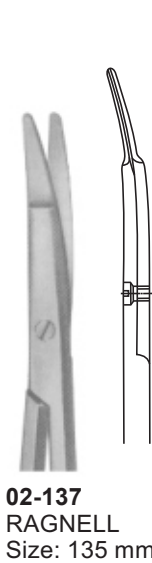

02-137
RAGNELL
Size: 135 mm

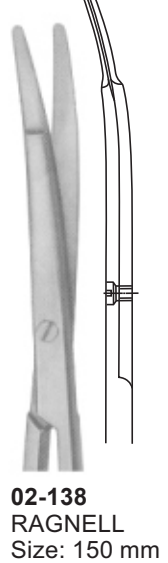

02-138
RAGNELL
Size: 150 mm

1/2
02-134 - 135
METZENBAUM
Dissecting Scissors
Size: 145 mm

1/2
02-136 - 138
Special flat points for
dissecting and
undermining the skin
Size: 145 mm

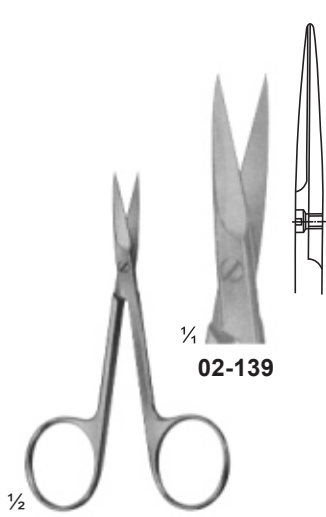

02-139-140
 Cuticle
 Size: 90 mm

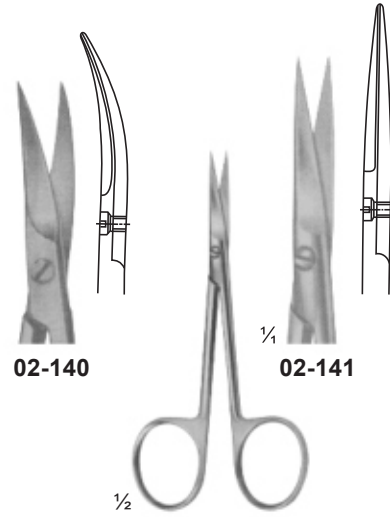

02-141 - 142
 Iris
 Size: 95 mm

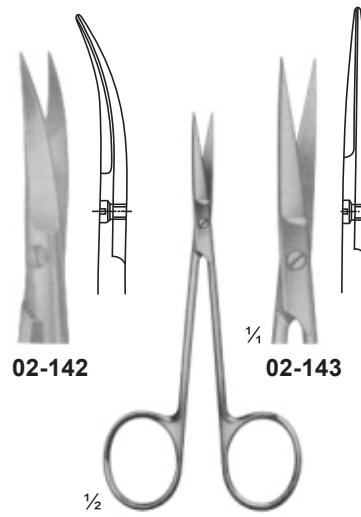

02-143 - 144
 Iris
 Size: 100 mm

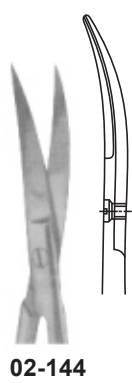

02-144

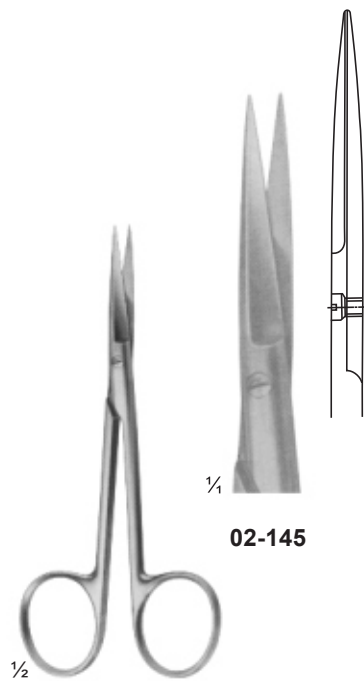

02-145 - 146
 Wagner
 Size: 130 mm

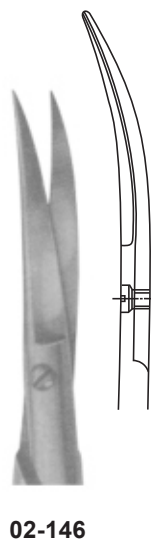

02-146

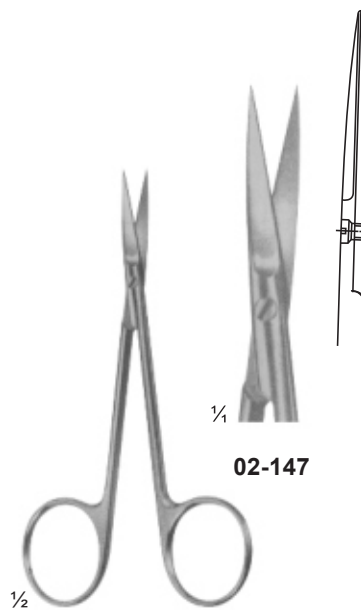

02-147 - 148
 Iris
 Size: 110 mm

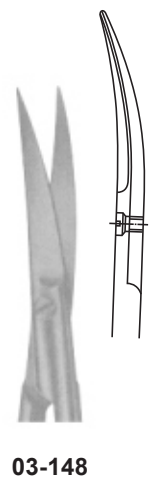

03-148

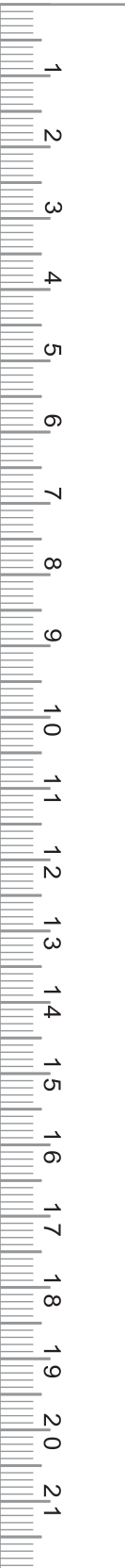



1/2

02-149 - 151
Fine Operating Scissors
Size: 120 mm

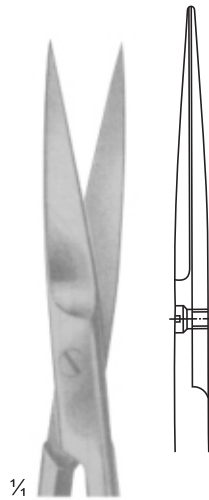

1/4

02-149

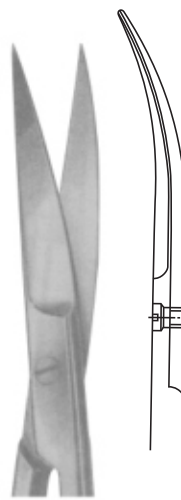

02-150

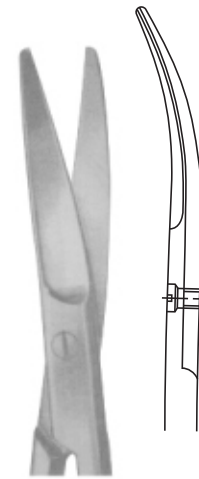

02-151



1/2

02-152 - 155
Fine Operating Scissors
Size: 130 mm

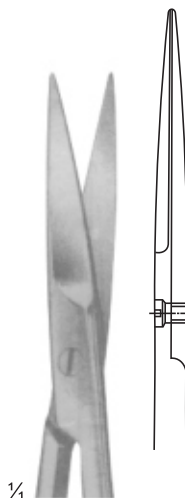

1/4

02-152

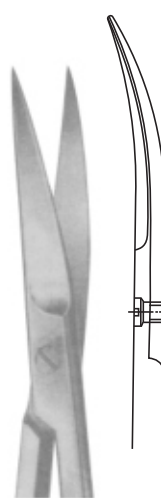

02-153

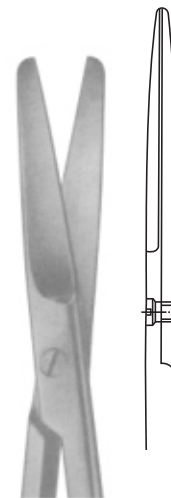

02-154

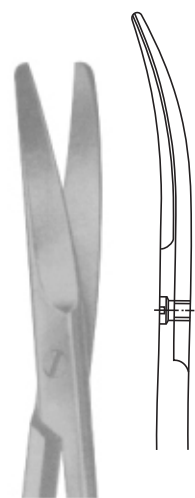

02-155

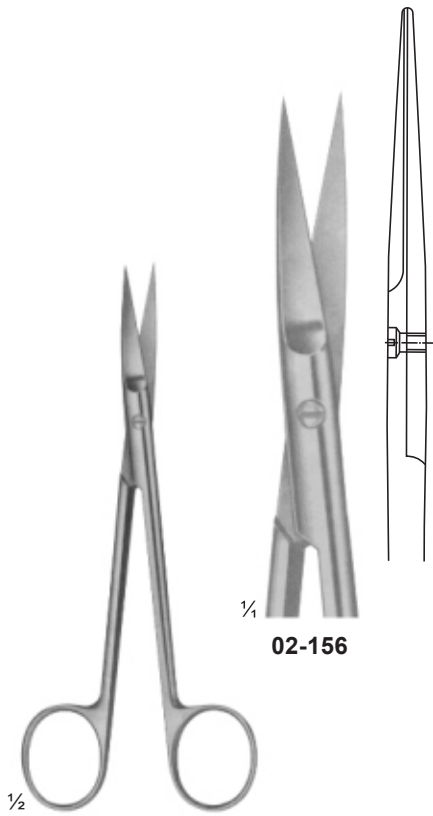

1/4
02-156

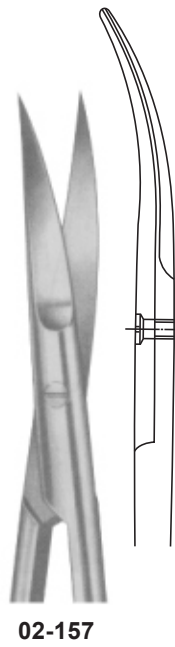

02-157

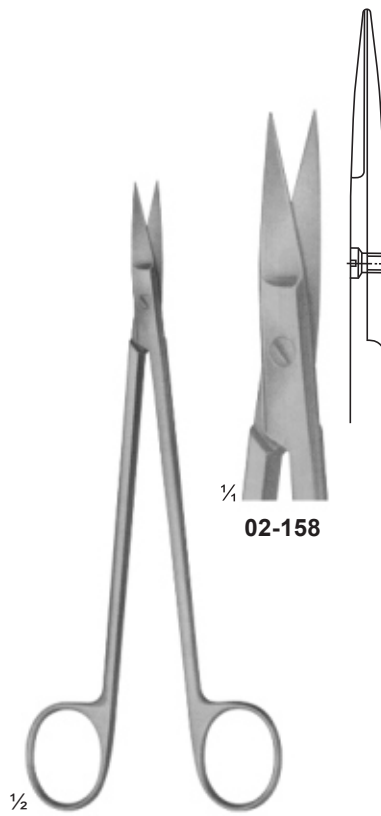

1/4
02-158

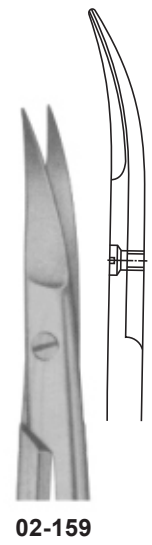

02-159

02-156 - 157
JOSEPH
Size: 150 mm

02-158 - 159
KELLY
Size: 175 mm

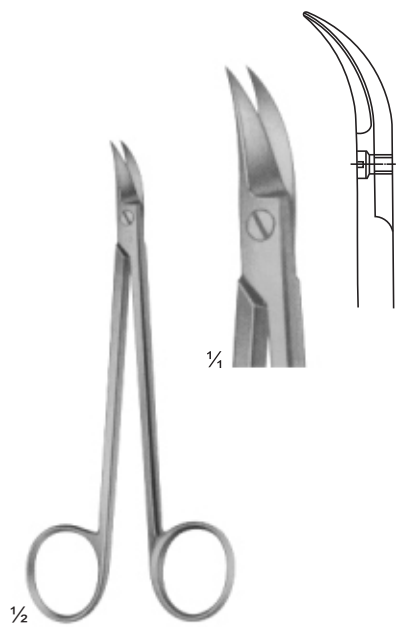

1/2
02-160
QUINBY
Size: 130 mm

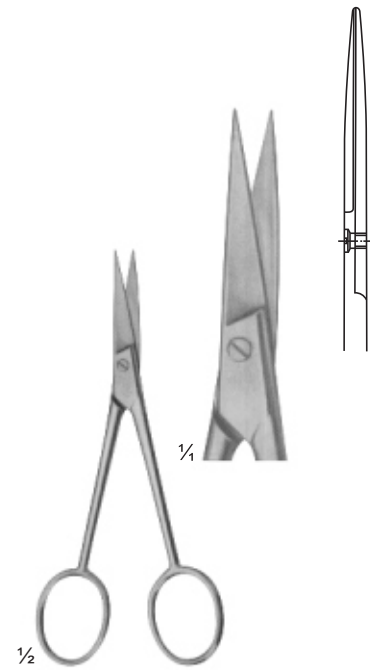

1/4
02-161
Dissecting
Size: 110 mm



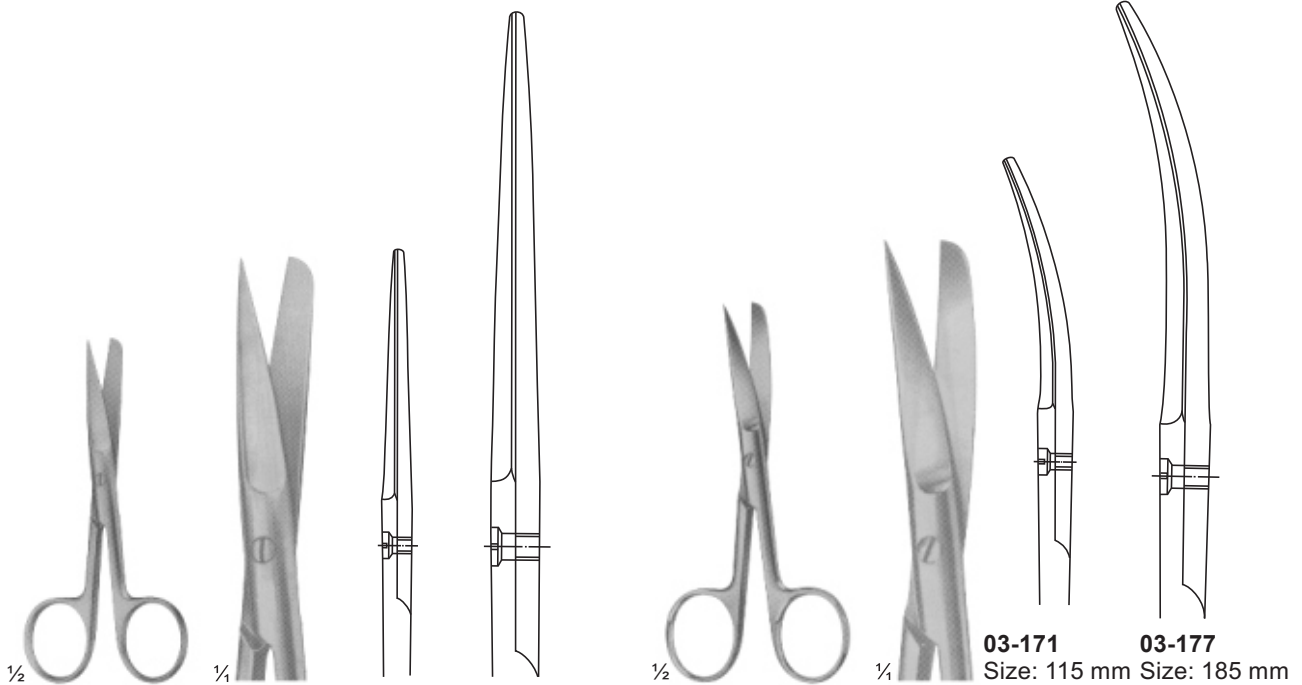

02-162 - 170 (Standard Types)

- 02-162 (105 mm)
- 02-163 (115 mm)
- 02-164 (130 mm)
- 02-165 (145 mm)
- 02-166 (150 mm)
- 02-167 (165 mm)
- 02-168 (175 mm)
- 02-169 (185 mm)
- 02-170 (200 mm)

02-162

Size: 105 mm

02-170

Size: 200 mm

02-171 - 177 (Standard Types)

- 02-171 (115 mm)
- 02-172 (130 mm)
- 02-173 (145 mm)
- 02-174 (150 mm)
- 02-175 (165 mm)
- 02-176 (175 mm)
- 02-177 (185 mm)

03-171

Size: 115 mm

03-177

Size: 185 mm

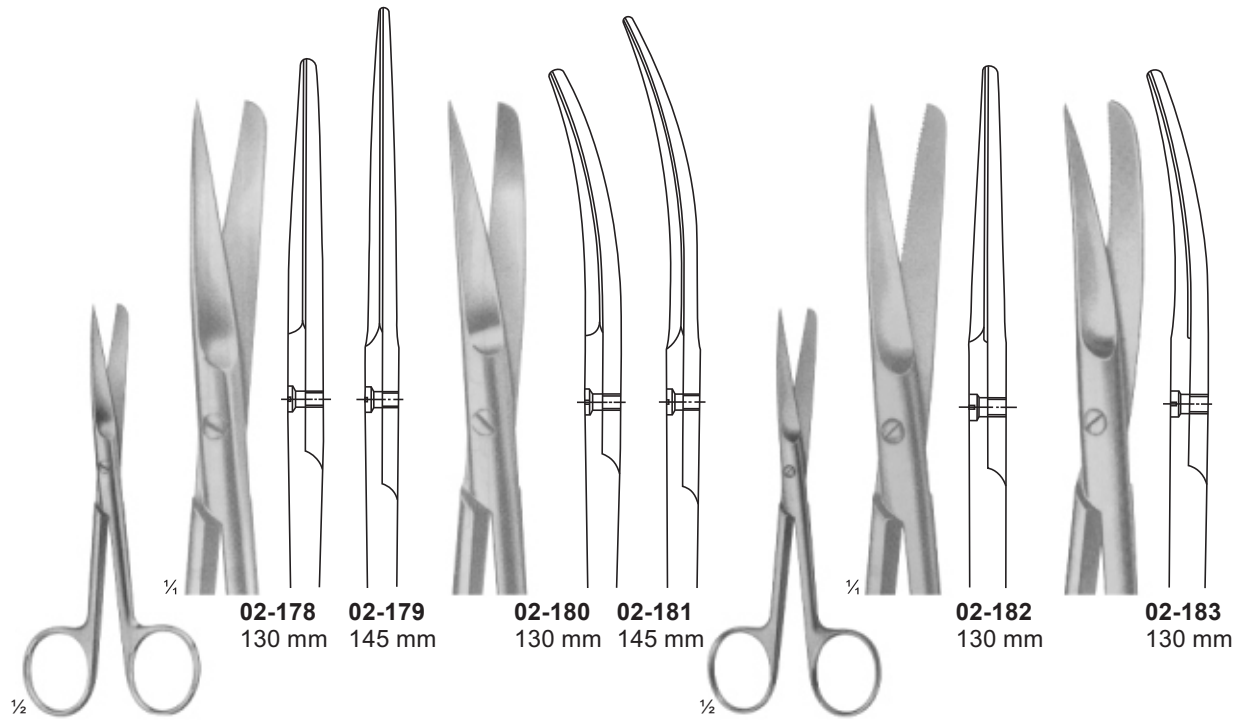

02-178 - 181
Slender Types

02-178
130 mm

02-179
145 mm

02-180
130 mm

02-181
145 mm

02-182
130 mm

02-183
130 mm

02-182 - 183
For Wound Edges
1 Blade Serrated

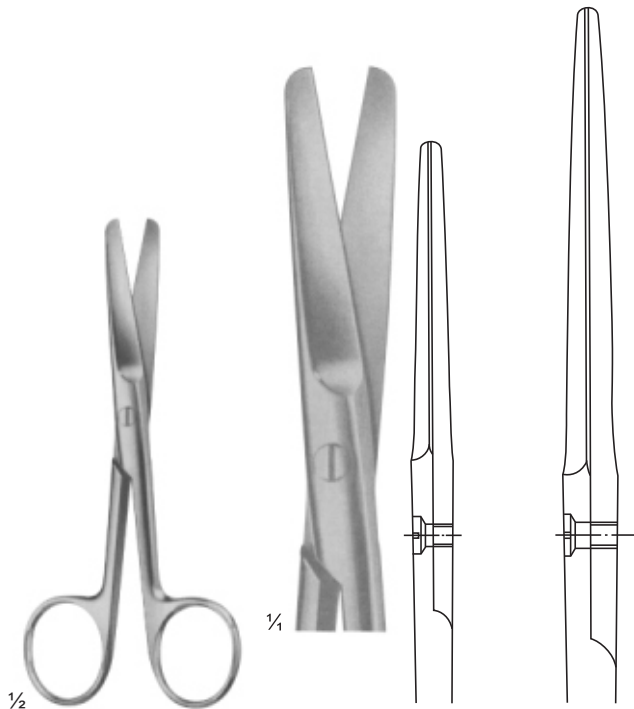

02-184 - 188 (Standard Types) Size: 130 mm Size: 175 mm
02-184 (130 mm)
02-185 (145 mm)
02-186 (150 mm)
02-187 (165 mm)
02-188 (175 mm)

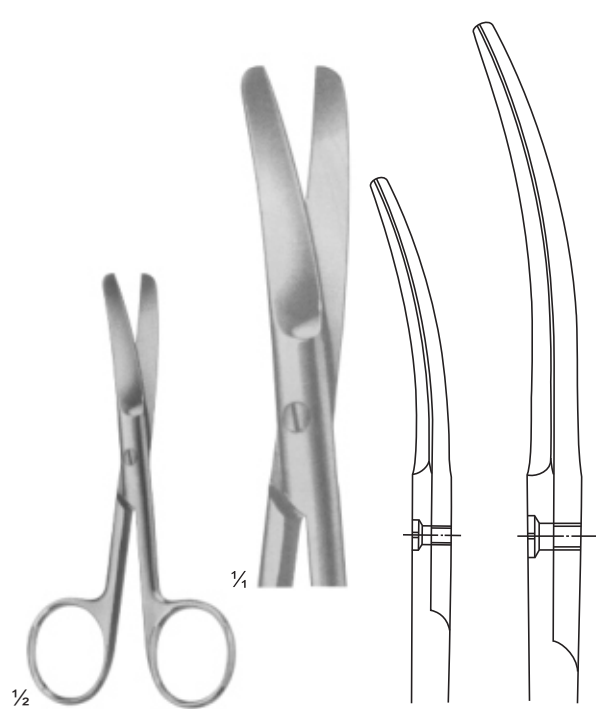

02-189 - 194 - COOPER Size: 115 mm Size: 175 mm
02-189 (115 mm)
02-190 (130 mm)
02-191 (145 mm)
02-192 (150 mm)
02-193 (165 mm)
02-194 (175 mm)

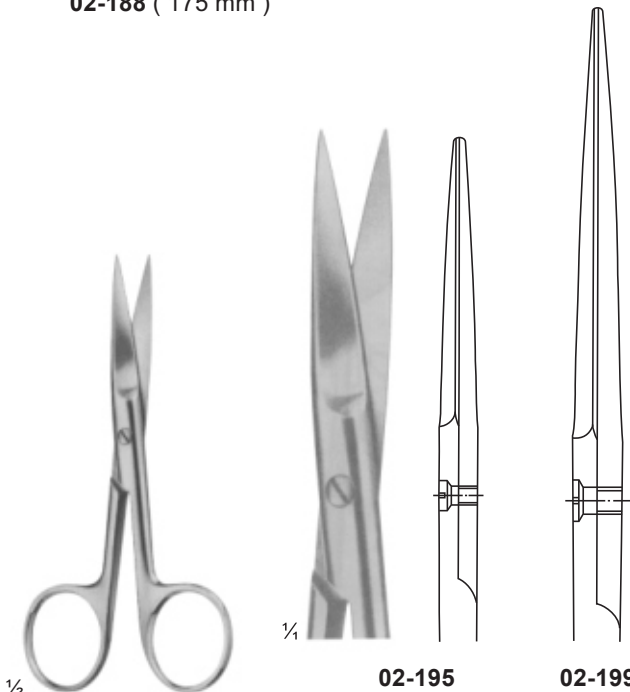

02-195 - 199
02-195 (115 mm)
02-196 (130 mm)
02-197 (145 mm)
02-198 (150 mm)
02-199 (165 mm)

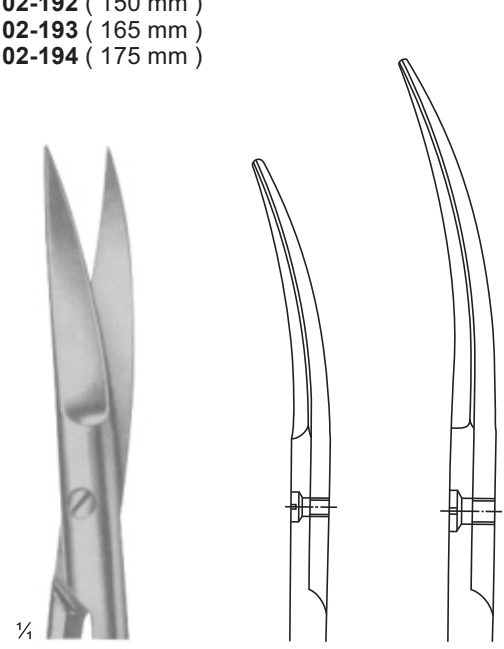

02-200 - 203
02-200 (115 mm)
02-201 (130 mm)
02-202 (145 mm)
02-203 (150 mm)





1/2

02-204 - 206
DEAVER
With flat lock

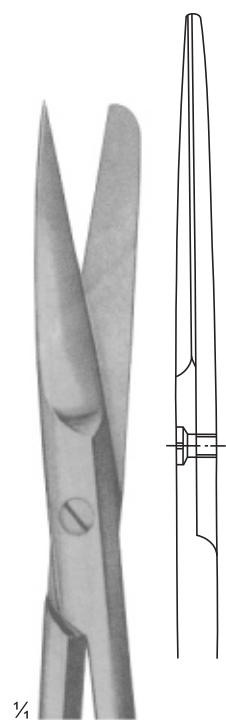

1/4

02-204
Size: 145 mm

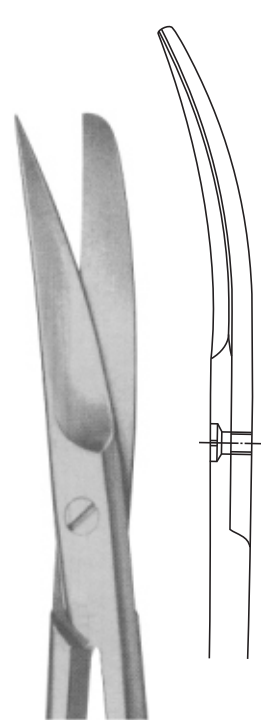

02-205
Size: 145 mm

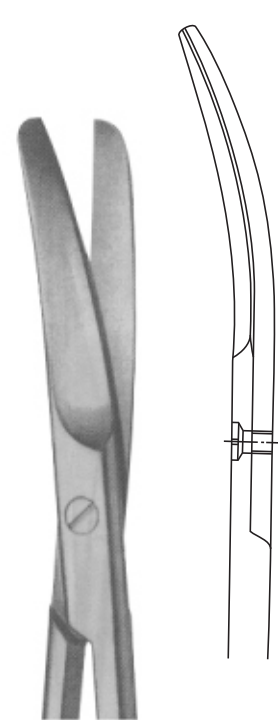

02-206
Size: 145 mm



1/2

02-207 - 209
Incision Scissors

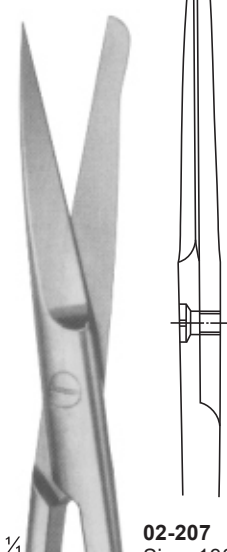

1/4

02-207
Size: 130 mm

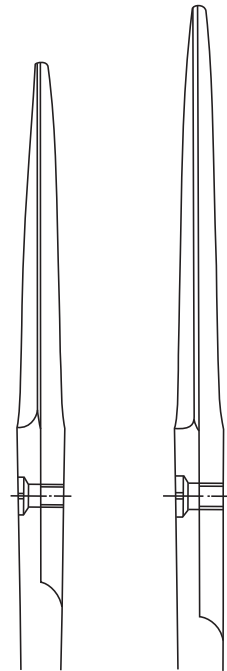

02-208
Size: 145 mm

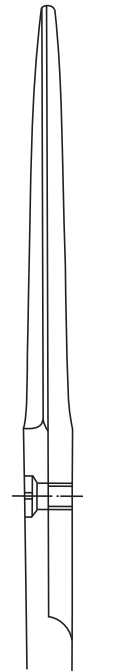

02-209
Size: 165 mm

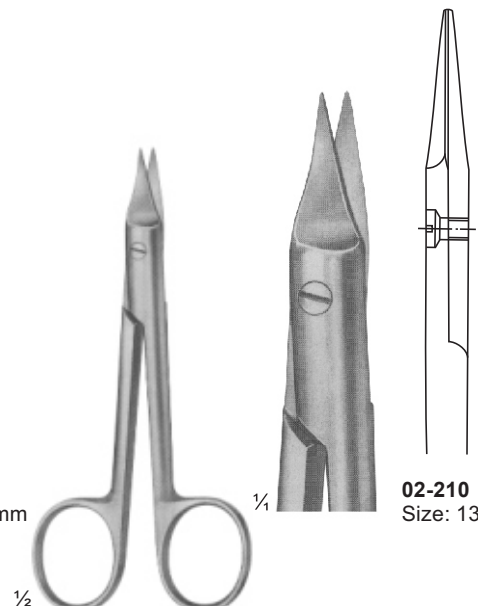

1/2

02-210
SYSTRUNK
Nail Splitting Scissors

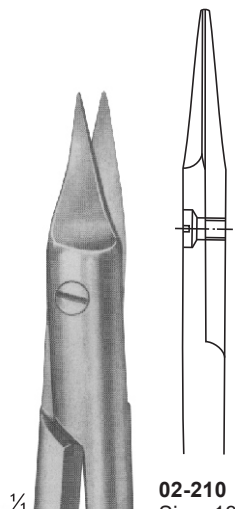

1/4

02-210
Size: 130 mm

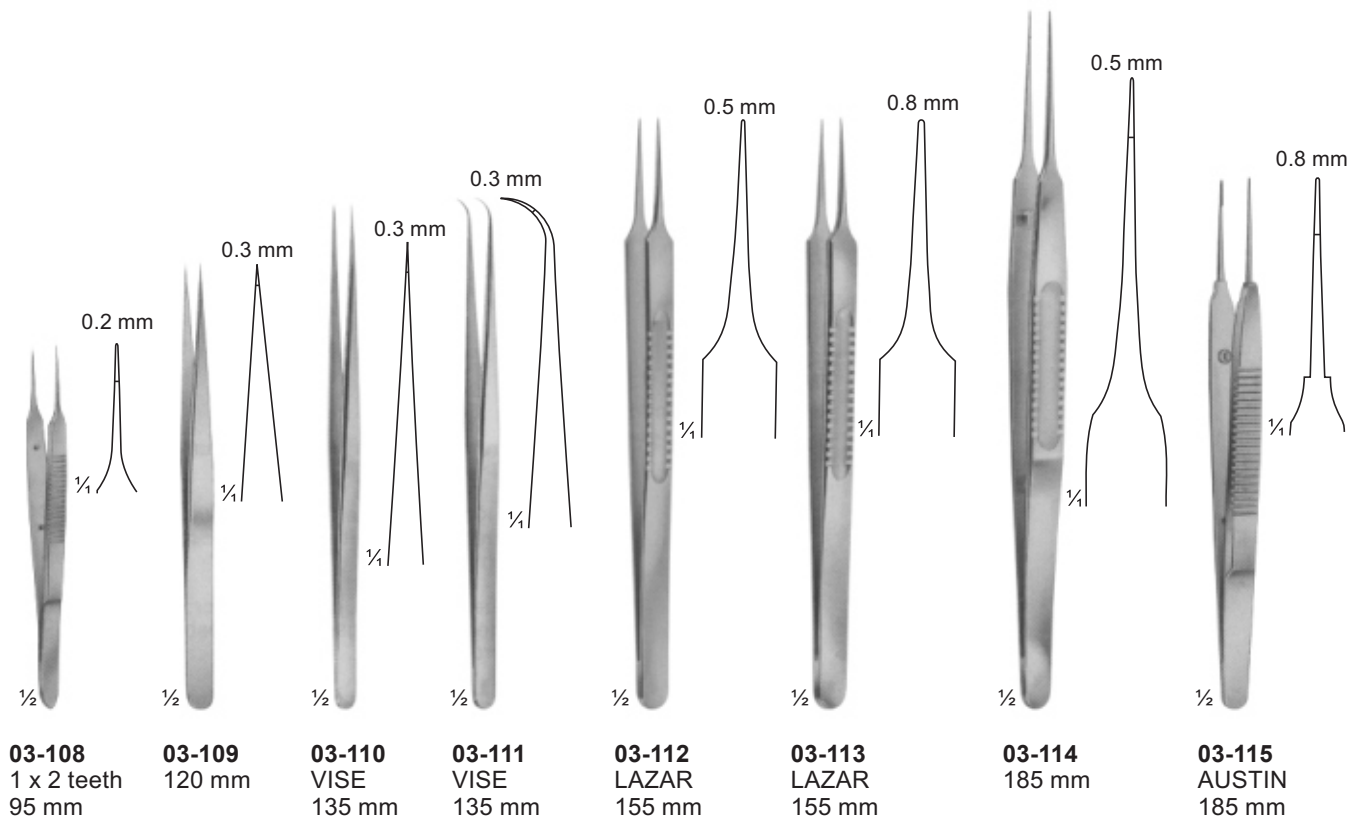
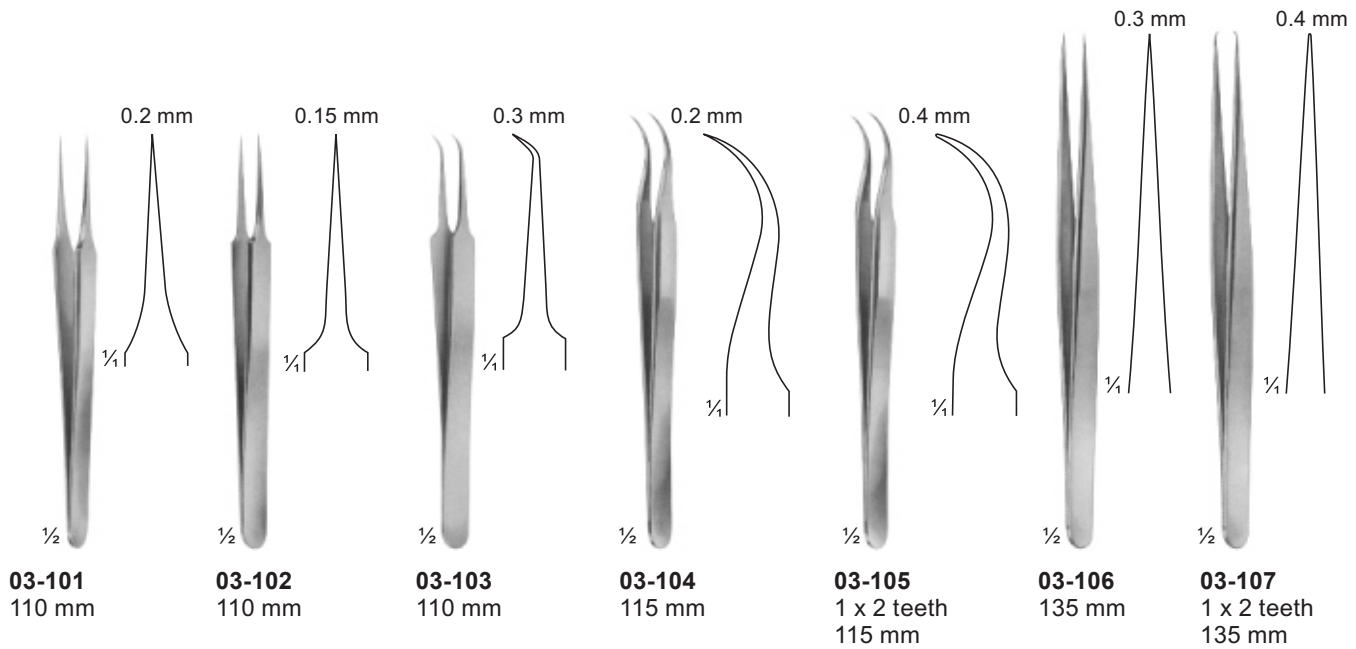



Ligature Forceps, Micro Forceps (light Patterns)
Ligaturklemmen, Mikropinzette (light Patterns)
Pinzas De Ligadura, Pinzas Micro (patrones De Luz)

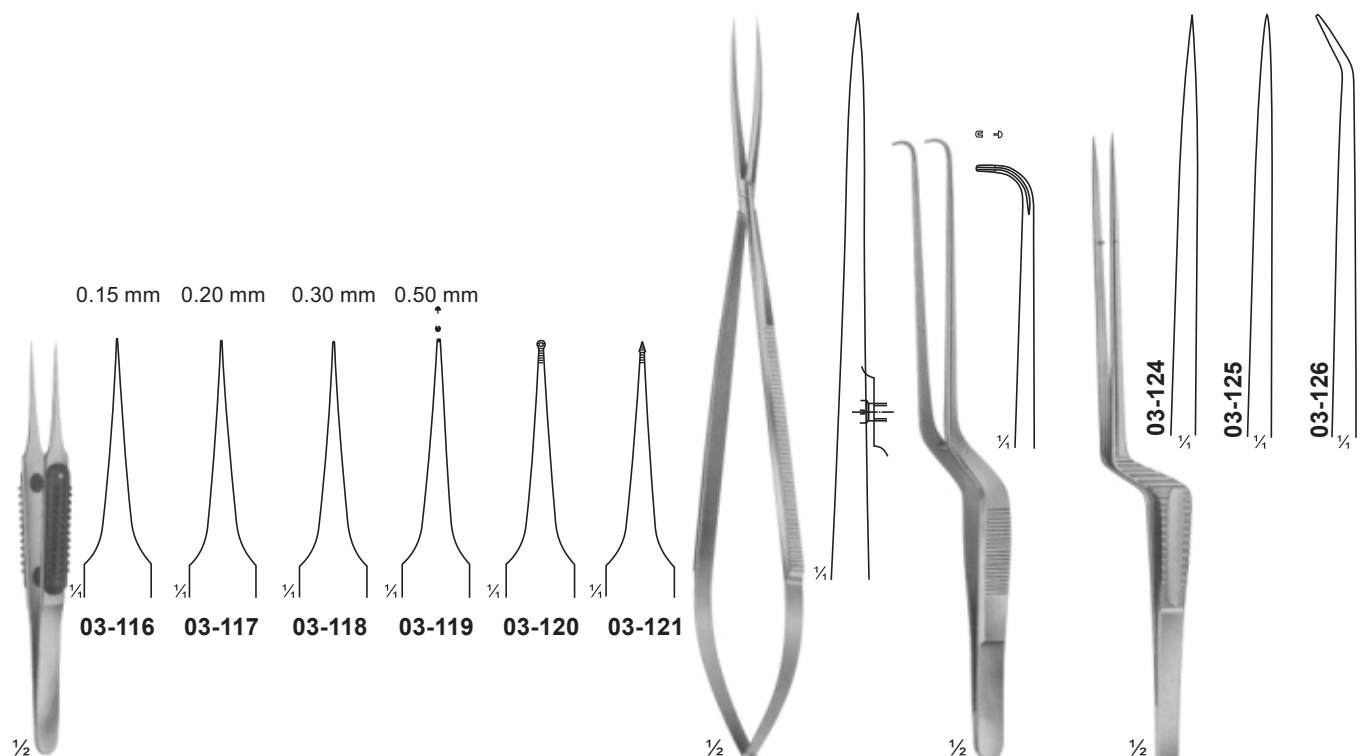

03-116 - 121
MULLER
110 mm

03-122
LIGATURE FORCEPS
220 mm

03-123
YASARGIL
185 mm

03-124 - 126
MICRO FORCEPS
185 mm

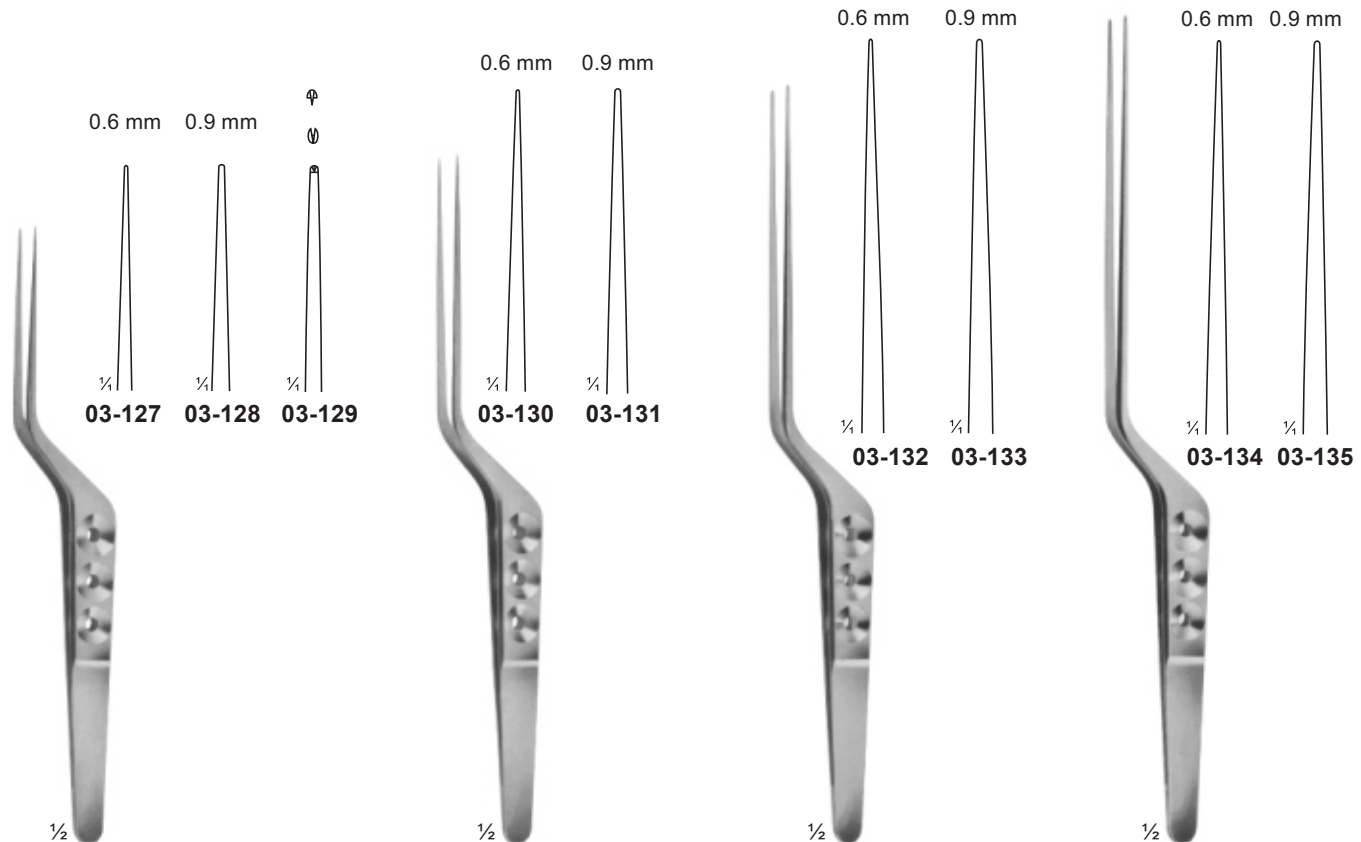

03-127 - 129
YASARGIL
180 mm

03-130 - 131
YASARGIL
200 mm

03-132 - 133
YASARGIL
220 mm

03-134 - 135
YASARGIL
240 mm



SNAZAN
INTERNATIONAL

Forceps For Grasping Tissue, Tumors Pinzette Zum Fassen Von Gewebe, Tumore Pinzas Para Sujetar Tejidos, Los Tumores

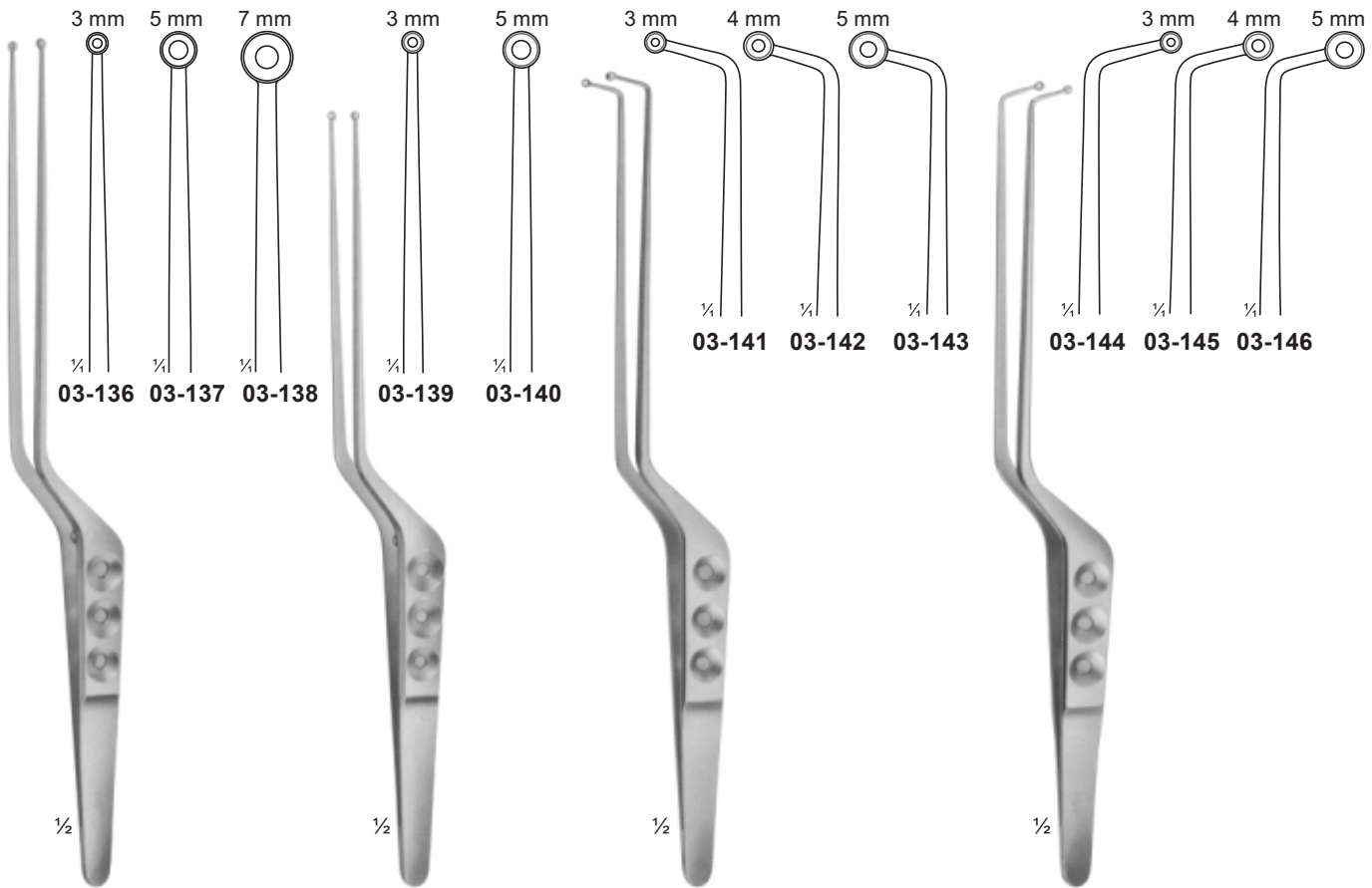

03-136 - 138
YASARGIL-SAMI
Jaws Spoon-Shaped
240 mm

03-139 - 140
YASARGIL
Jaws Spoon-Shaped
220 mm

03-141 - 143
SAMII
Jaws Spoon-Shaped
230 mm

03-144 - 146
SAMII
Jaws Spoon-Shaped
230 mm

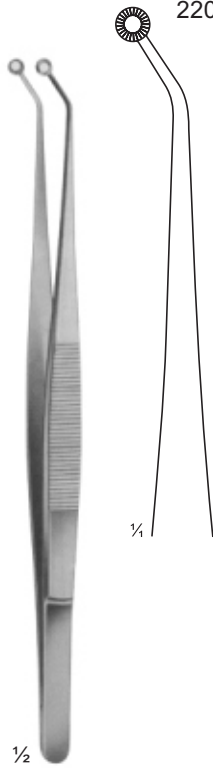

03-147
HUNT $\frac{1}{2}$
Tumor-and Vessel Forceps
200 mm

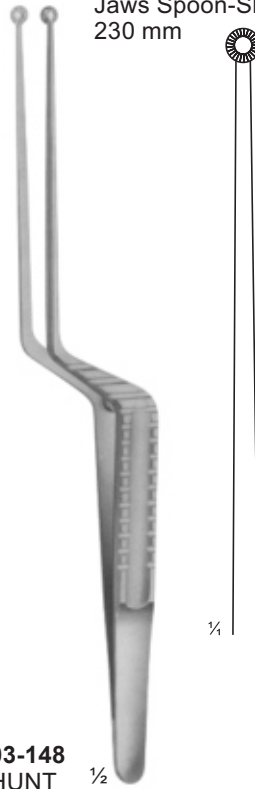

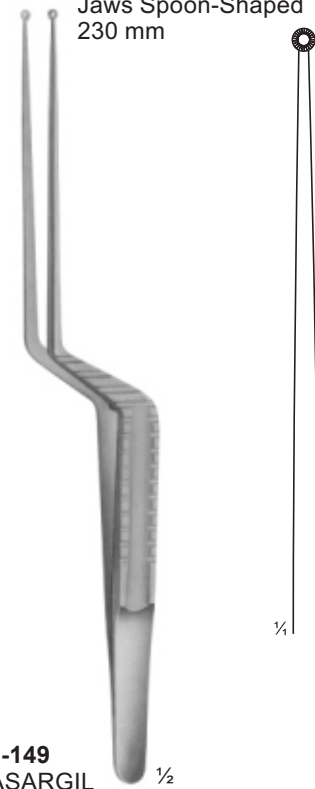

03-148
HUNT $\frac{1}{2}$
Tumor-and Vessel Forceps
200 mm



03-149
YASARGIL $\frac{1}{2}$
Tumor-and Vessel Forceps
200 mm



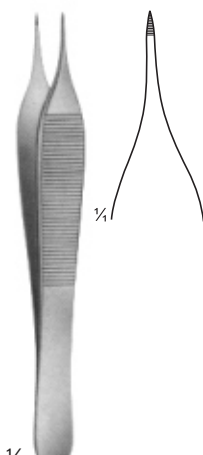
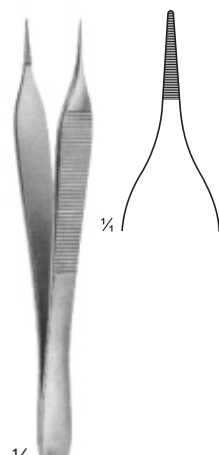
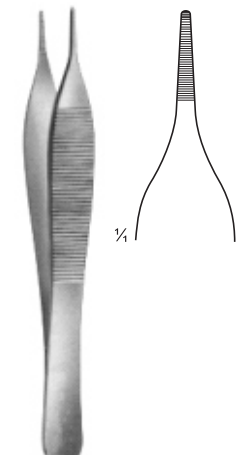
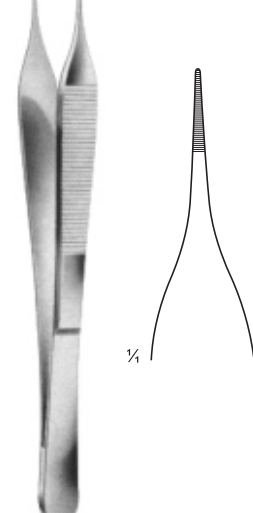
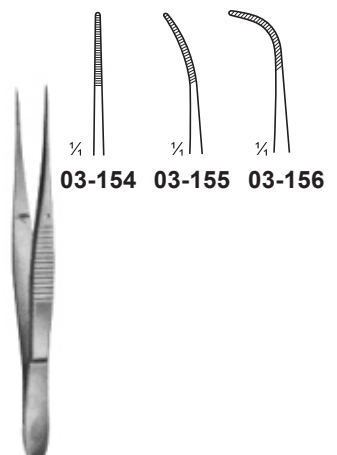
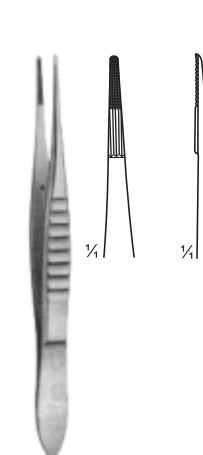
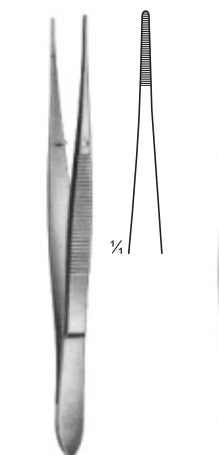
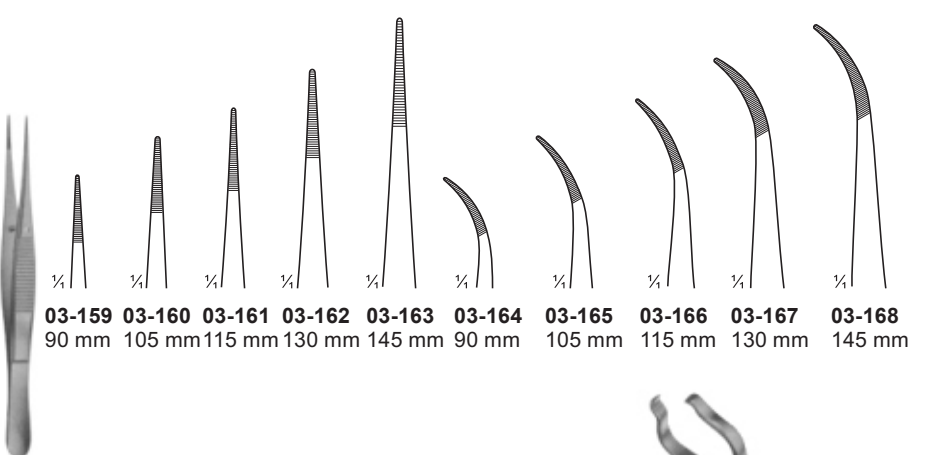
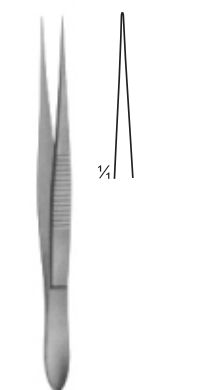
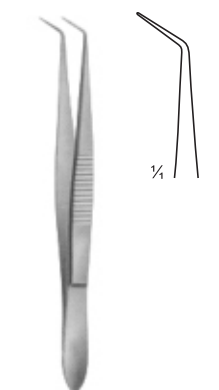
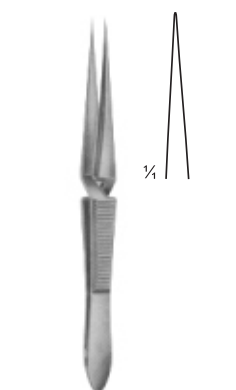
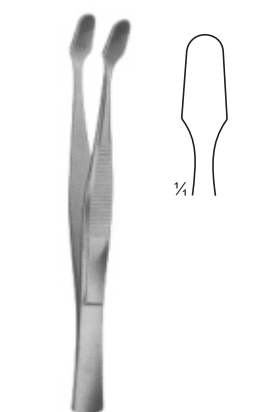

 <p>03-150 THORPE Corneal Forceps 120 mm</p>	 <p>03-151 MICRO-ADSON 120 mm</p>	 <p>03-152 ADSON 120 mm</p>	 <p>03-153 MICRO-ADSON 150 mm</p>	 <p>03-154 - 156 100 mm</p>
 <p>03-157 110 mm</p>	 <p>03-158 115 mm</p>	 <p>03-159 - 168</p> <p>03-159 90 mm 03-160 105 mm 03-161 115 mm 03-162 130 mm 03-163 145 mm 03-164 90 mm 03-165 105 mm 03-166 115 mm 03-167 130 mm 03-168 145 mm</p>		
 <p>03-169 100 mm</p>	 <p>03-170 100 mm</p>	 <p>03-171 100 mm</p>	 <p>03-172 COVER GLASS FORCEPS 105 mm</p>	 <p>03-173 160 mm</p>

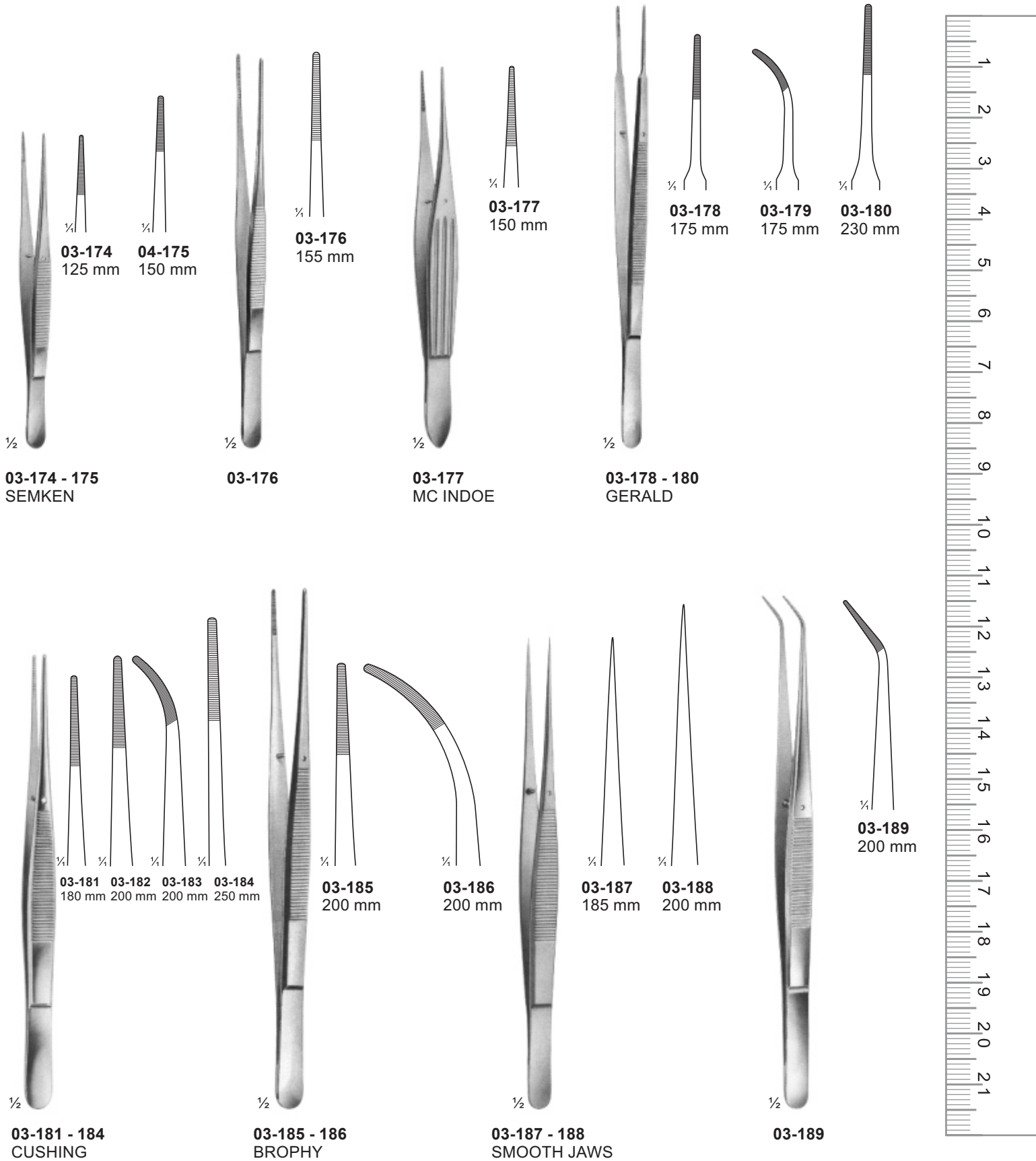

03-174 125 mm
04-175 150 mm
03-176 155 mm
03-177 150 mm
03-178 175 mm
03-179 175 mm
03-180 230 mm

03-174 - 175
SEMKEN

03-176

03-177
MC INDOE

03-178 - 180
GERALD

03-181 180 mm
03-182 200 mm
03-183 200 mm
03-184 250 mm
03-185 200 mm
03-186 200 mm
03-187 185 mm
03-188 200 mm
03-189 200 mm

03-181 - 184
CUSHING

03-185 - 186
BROPHY

03-187 - 188
SMOOTH JAWS

03-189



03-190 - 197
STANDARD

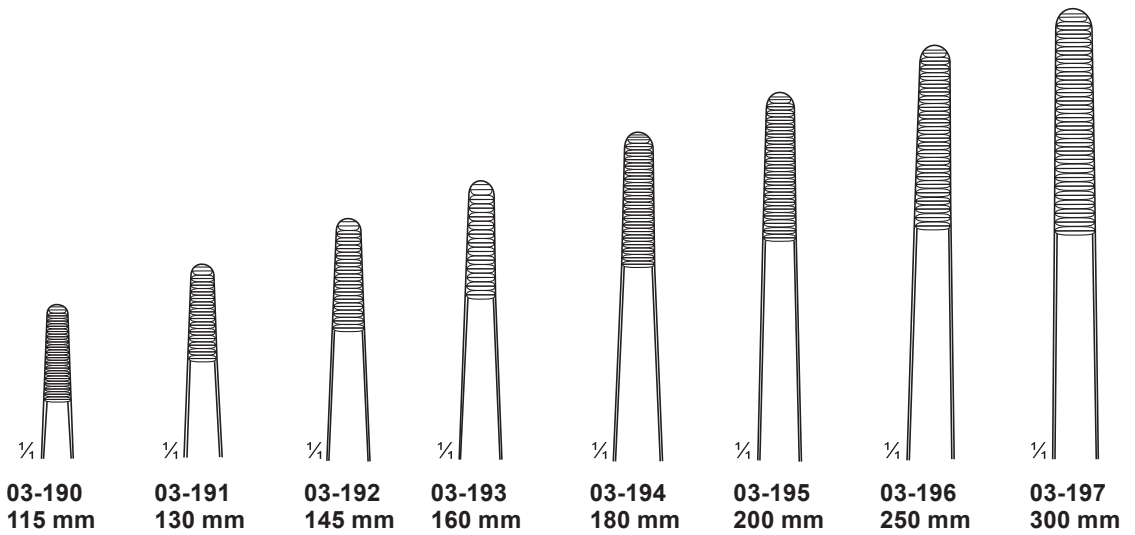

03-198 - 202
MEDIUM

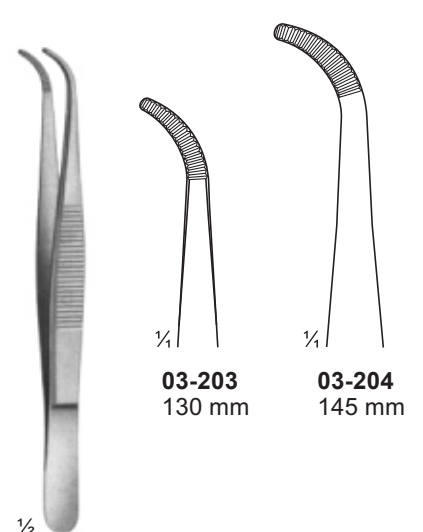
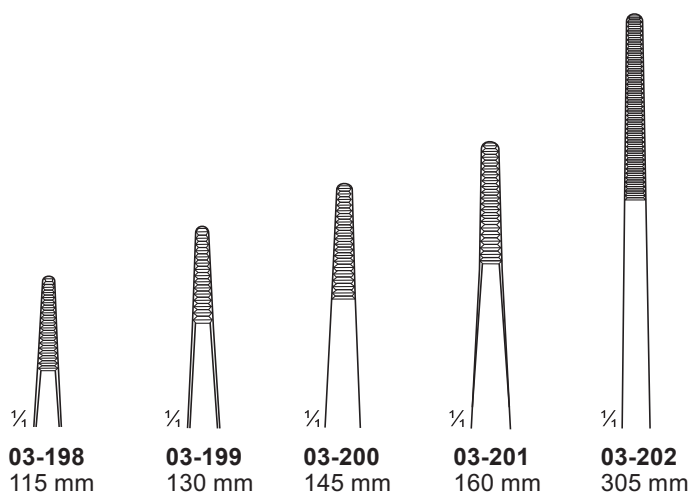

03-203 - 204
MEDIUM

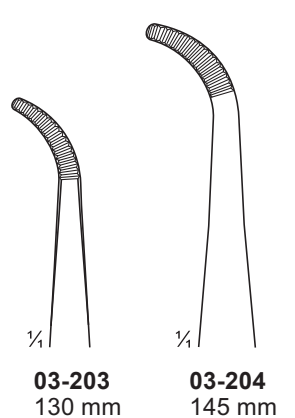

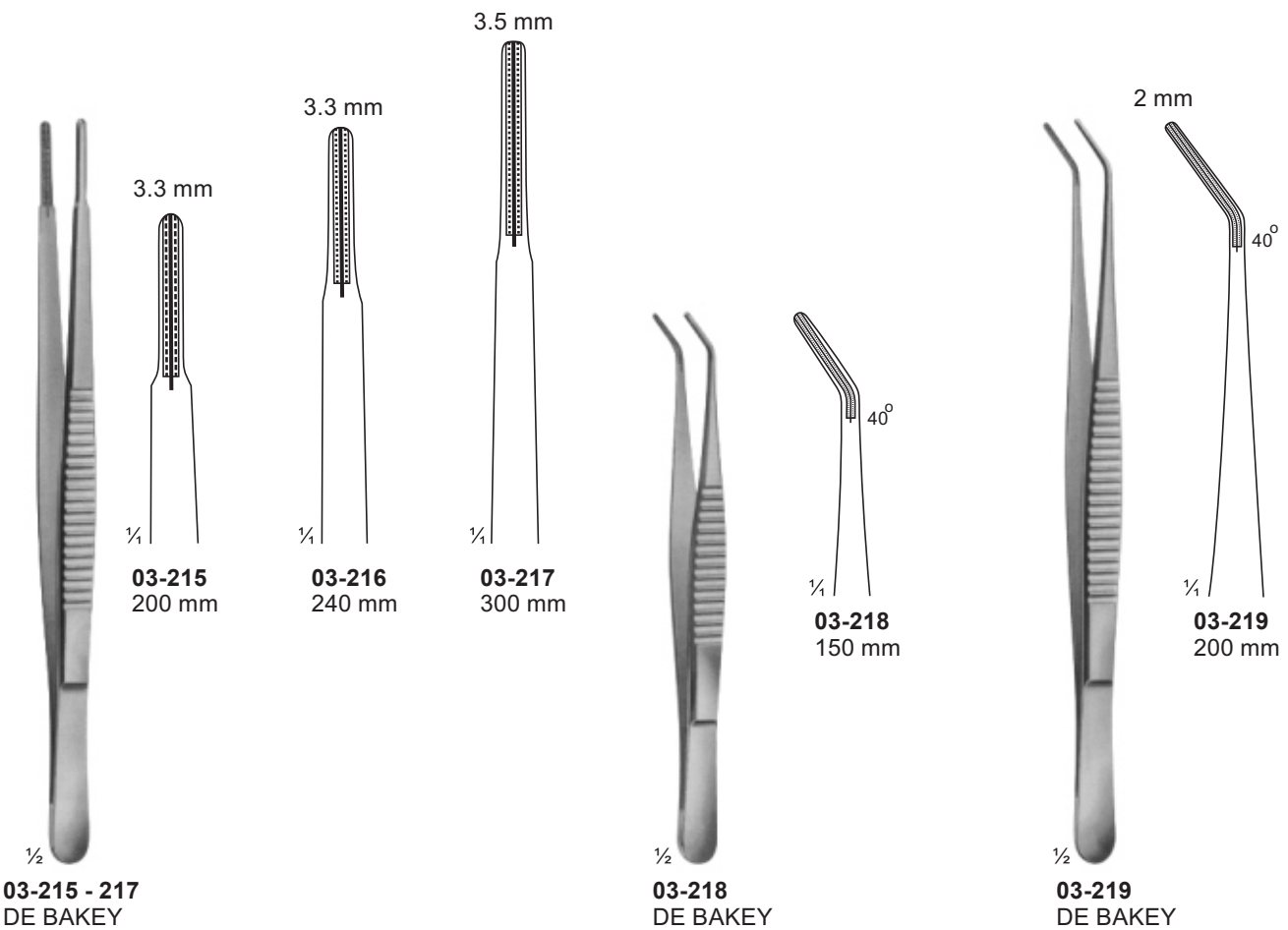
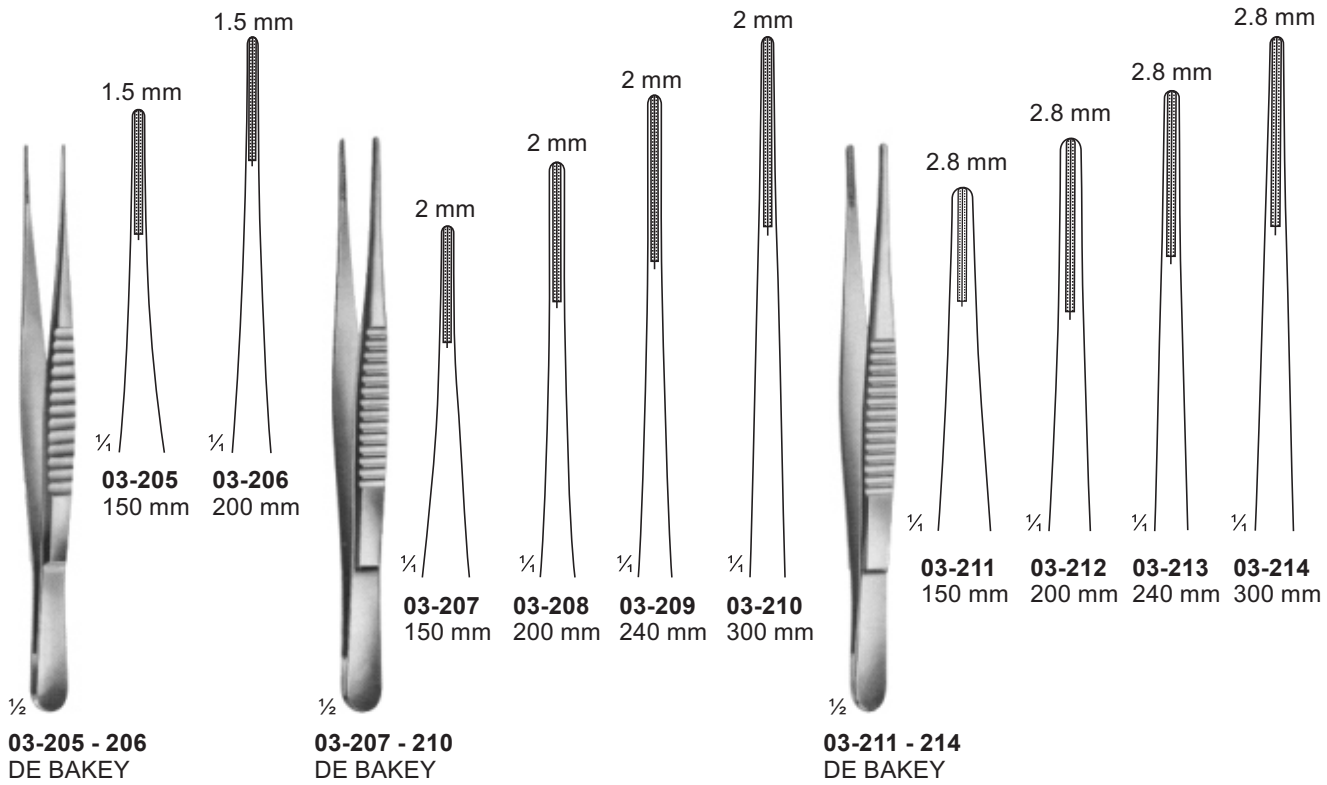

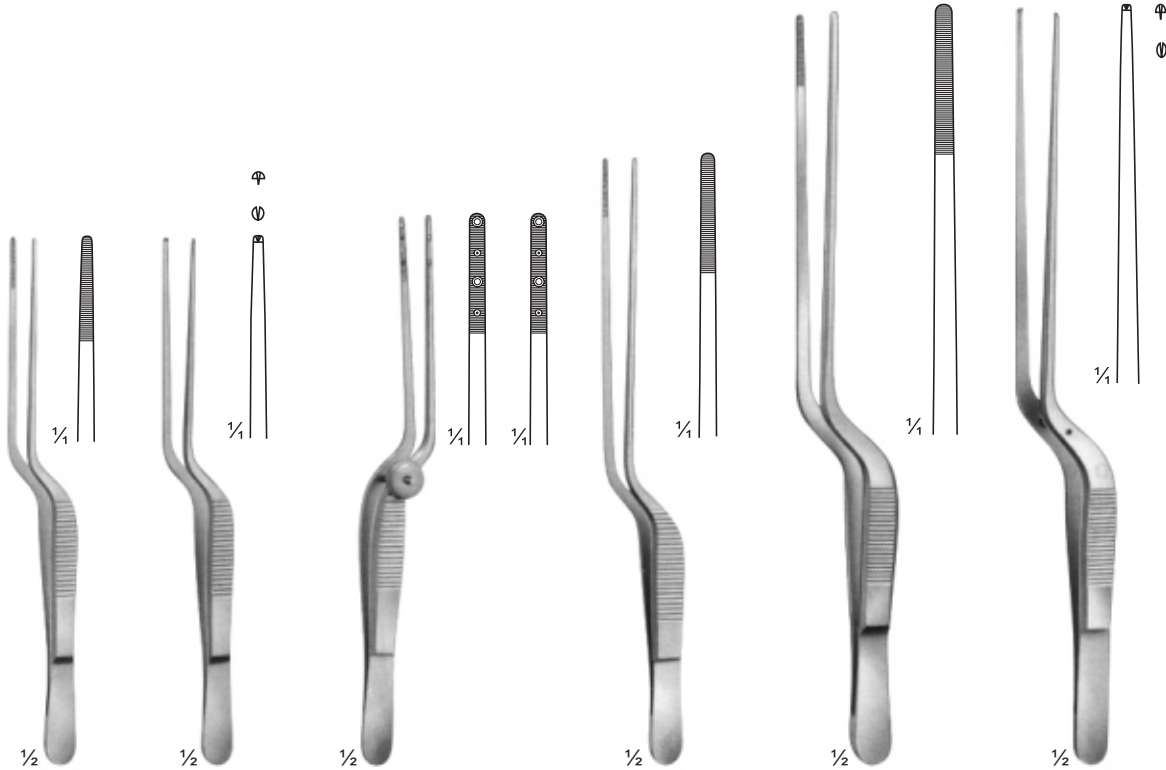

03-220
LUCAE
140 mm

03-221
LUCAE
1x2 teeth
140 mm

03-222
COTTLE
Forceps with
jaws toothed
and serrated
140 mm

03-223
JANSEN
160 mm

03-224
GRUENWALD
200 mm

03-225
1x2 teeth
200 mm

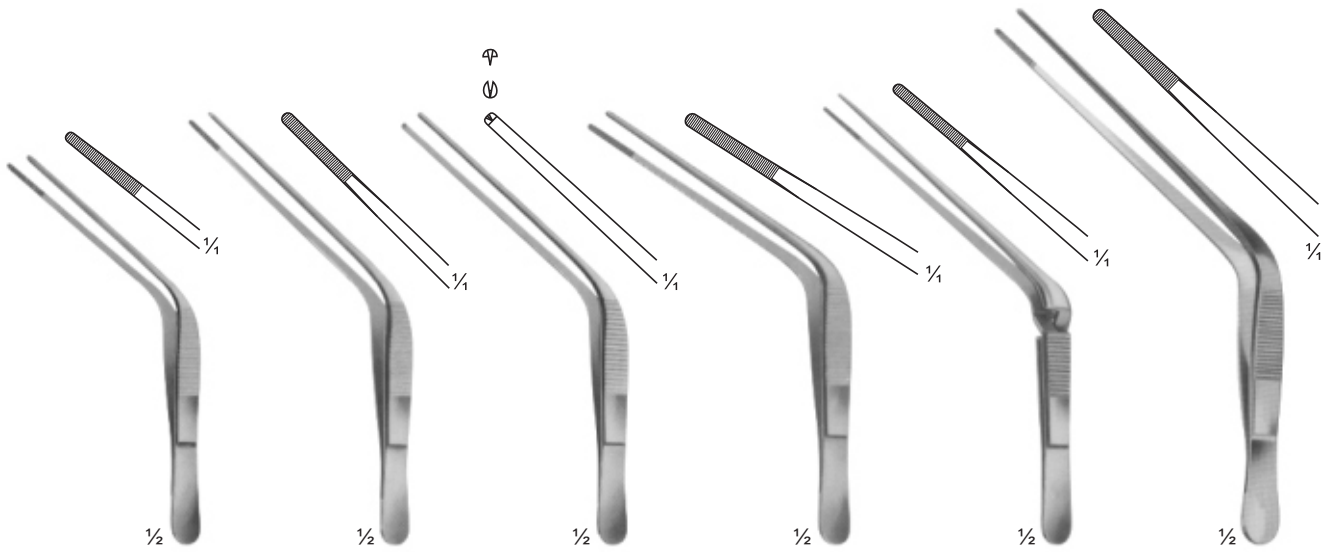

03-226
TROELTSCH
100 mm

03-227
TROELTSCH
115 mm

03-228
TROELTSCH
1X2 teeth
115 mm

03-229
WILDE
115 mm

03-230
TROELTSCH
Cross action
120 mm

03-231
TROELTSCH
140 mm

Delicate Tissue Forceps
Zarte Pinzette
Pinzas De Tejidos Delicados

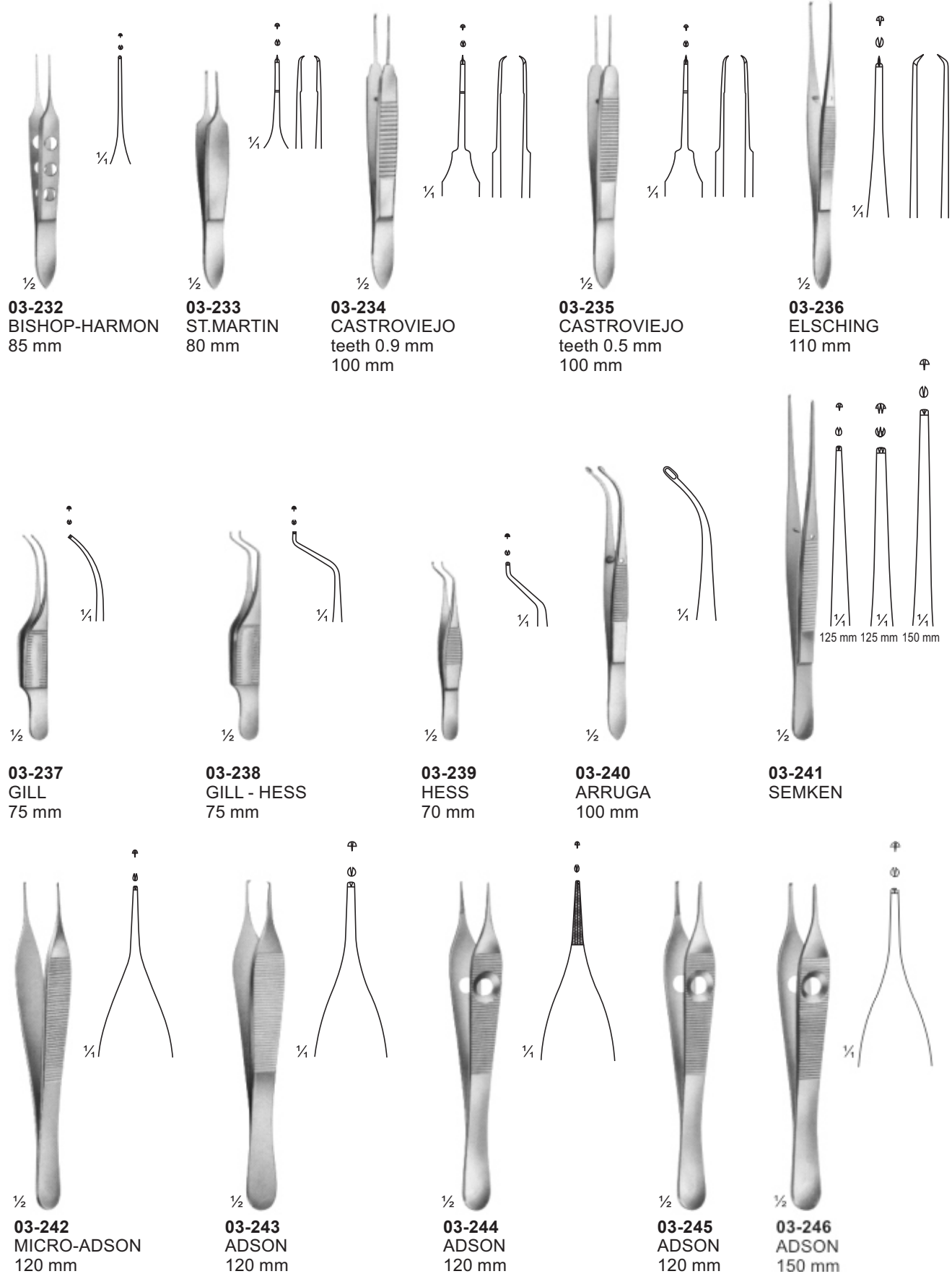

03-232
BISHOP-HARMON
 85 mm

03-233
ST.MARTIN
 80 mm

03-234
CASTROVIEJO
 teeth 0.9 mm
 100 mm

03-235
CASTROVIEJO
 teeth 0.5 mm
 100 mm

03-236
ELSCHING
 110 mm

03-237
GILL
 75 mm

03-238
GILL - HESS
 75 mm

03-239
HESS
 70 mm

03-240
ARRUGA
 100 mm

03-241
SEMKEN

125 mm 125 mm 150 mm

03-242
MICRO-ADSON
 120 mm

03-243
ADSON
 120 mm

03-244
ADSON
 120 mm

03-245
ADSON
 120 mm

03-246
ADSON
 150 mm



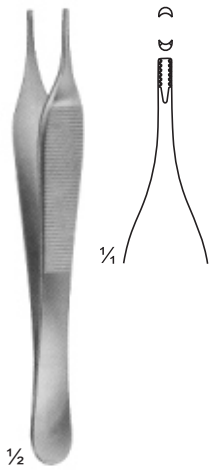

03-247
ADSON - BROWN
Non-traumatic
120 mm

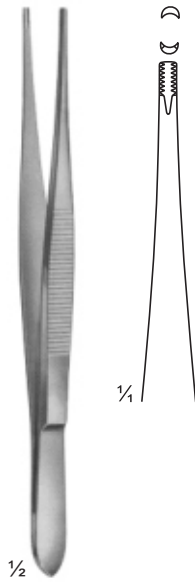

03-248
BROWN
120 mm

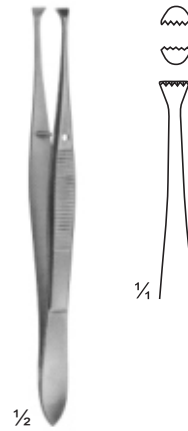

03-249
GRAEFE
110 mm

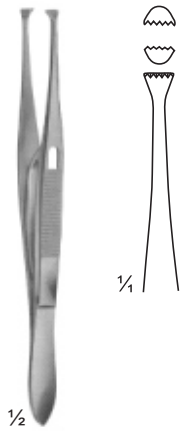

03-250
GRAEFE
With Catch
110 mm

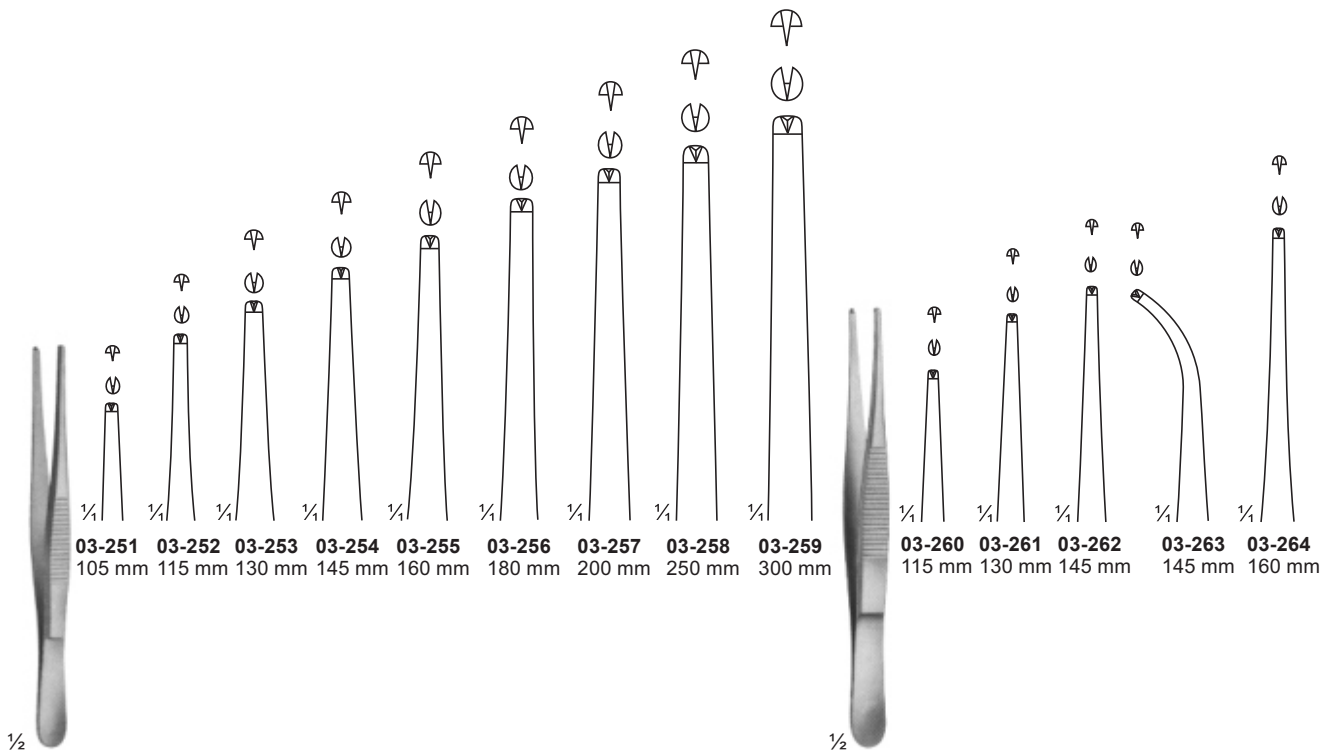

03-251 - 259
STANDARD

03-260 - 264
GRAEFE
110 mm

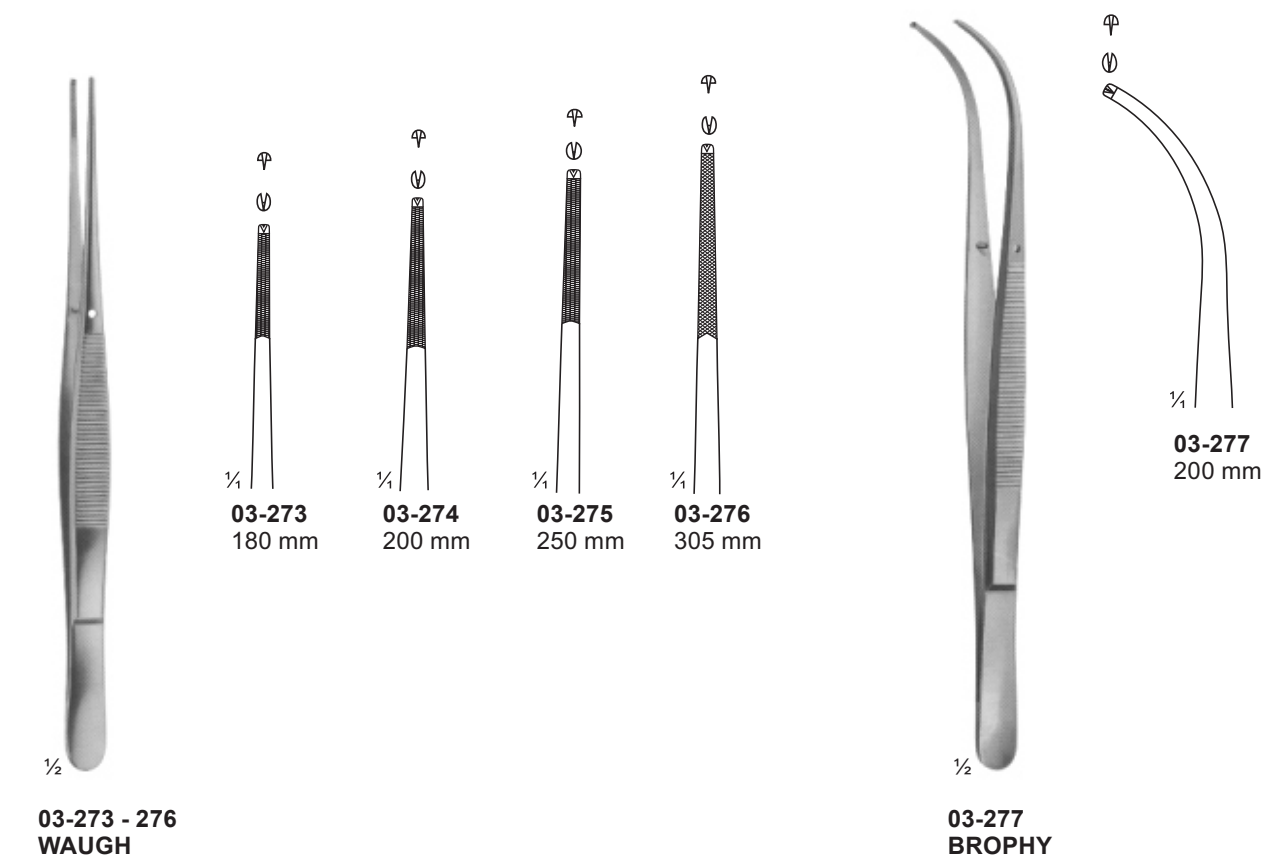
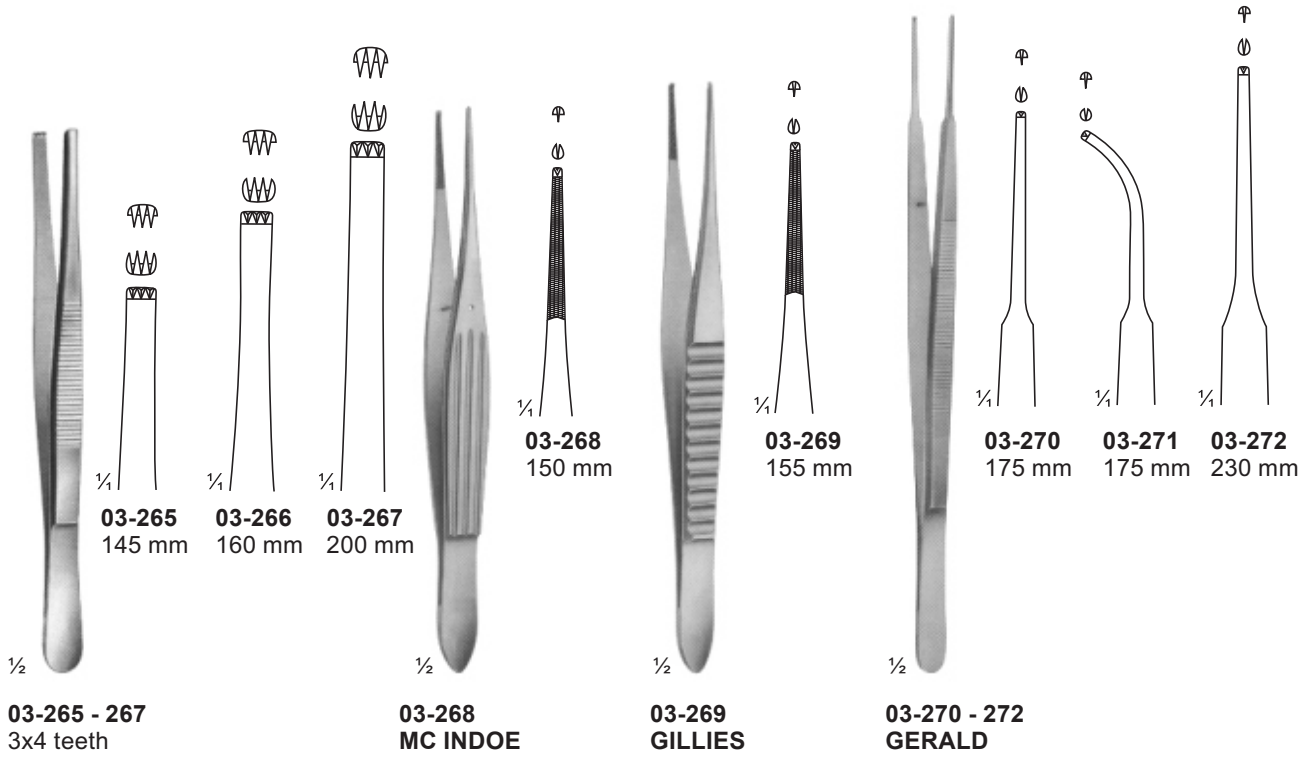

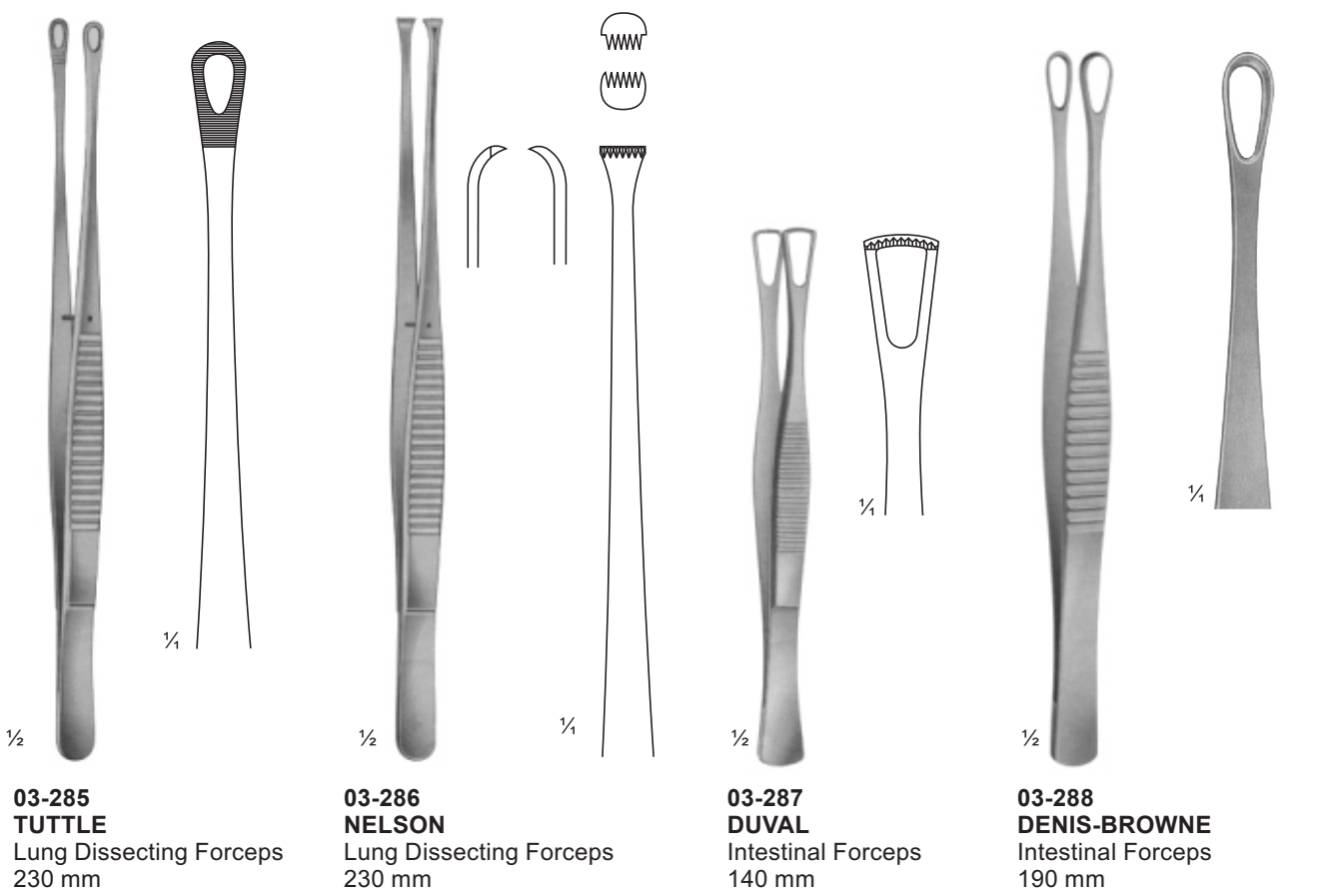
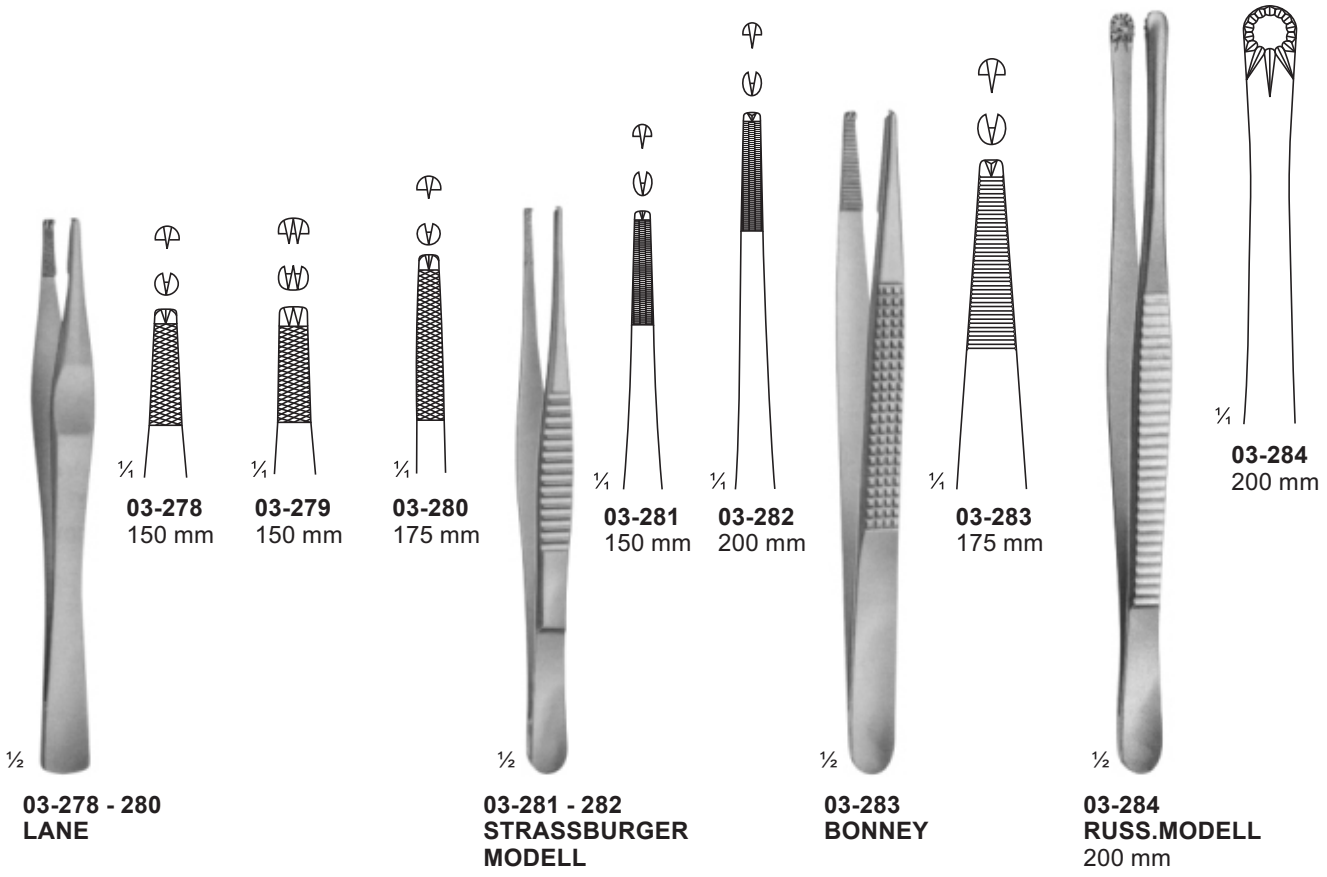
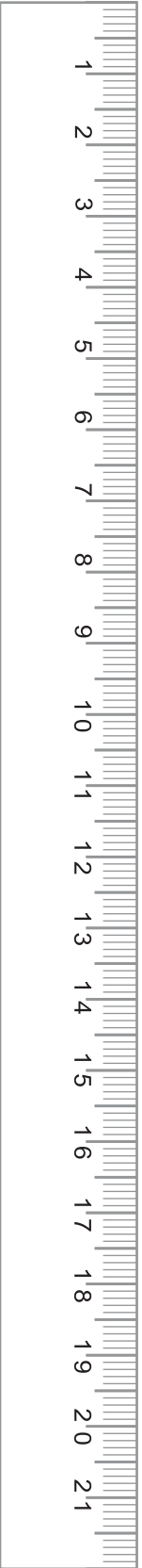

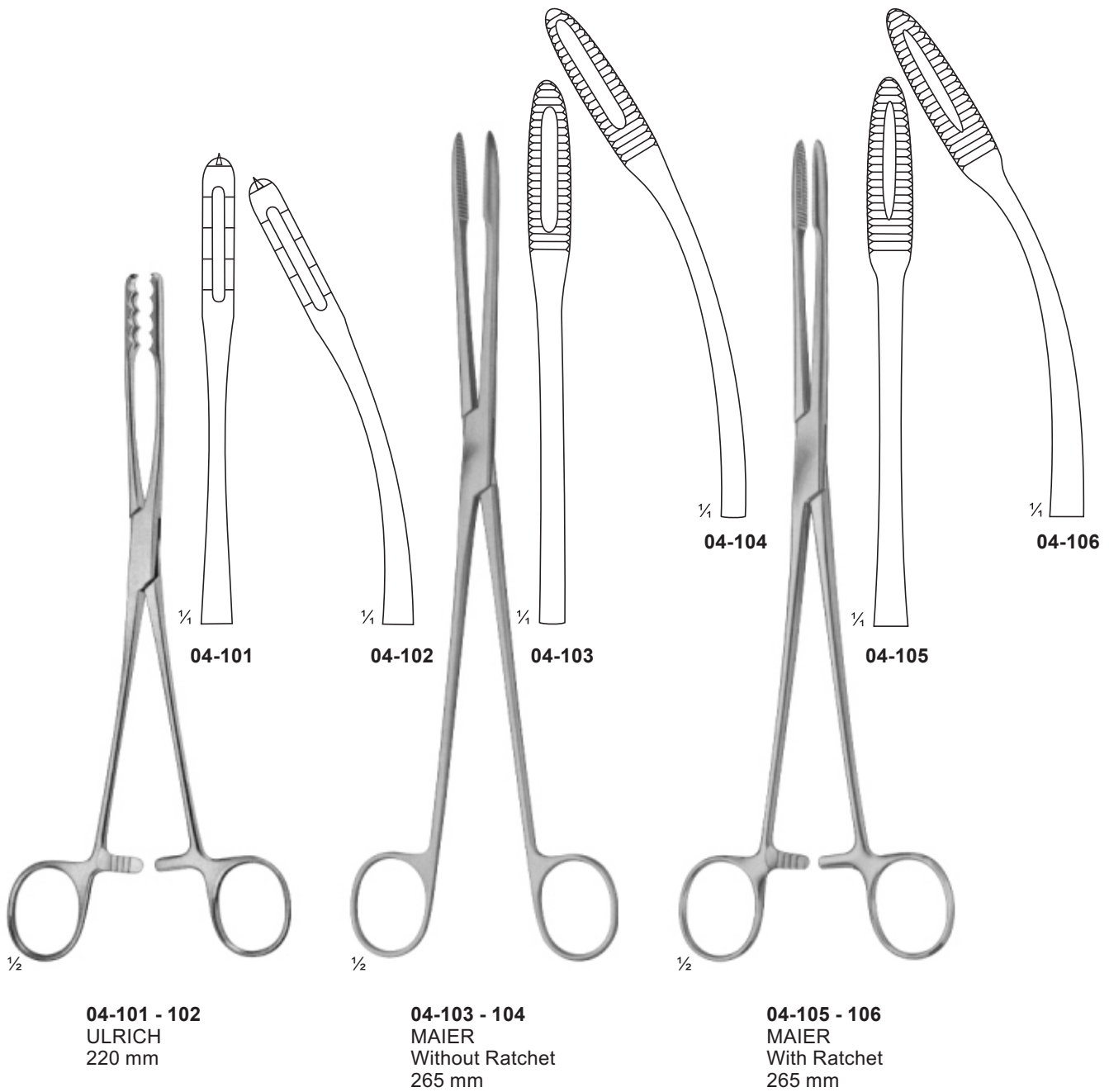

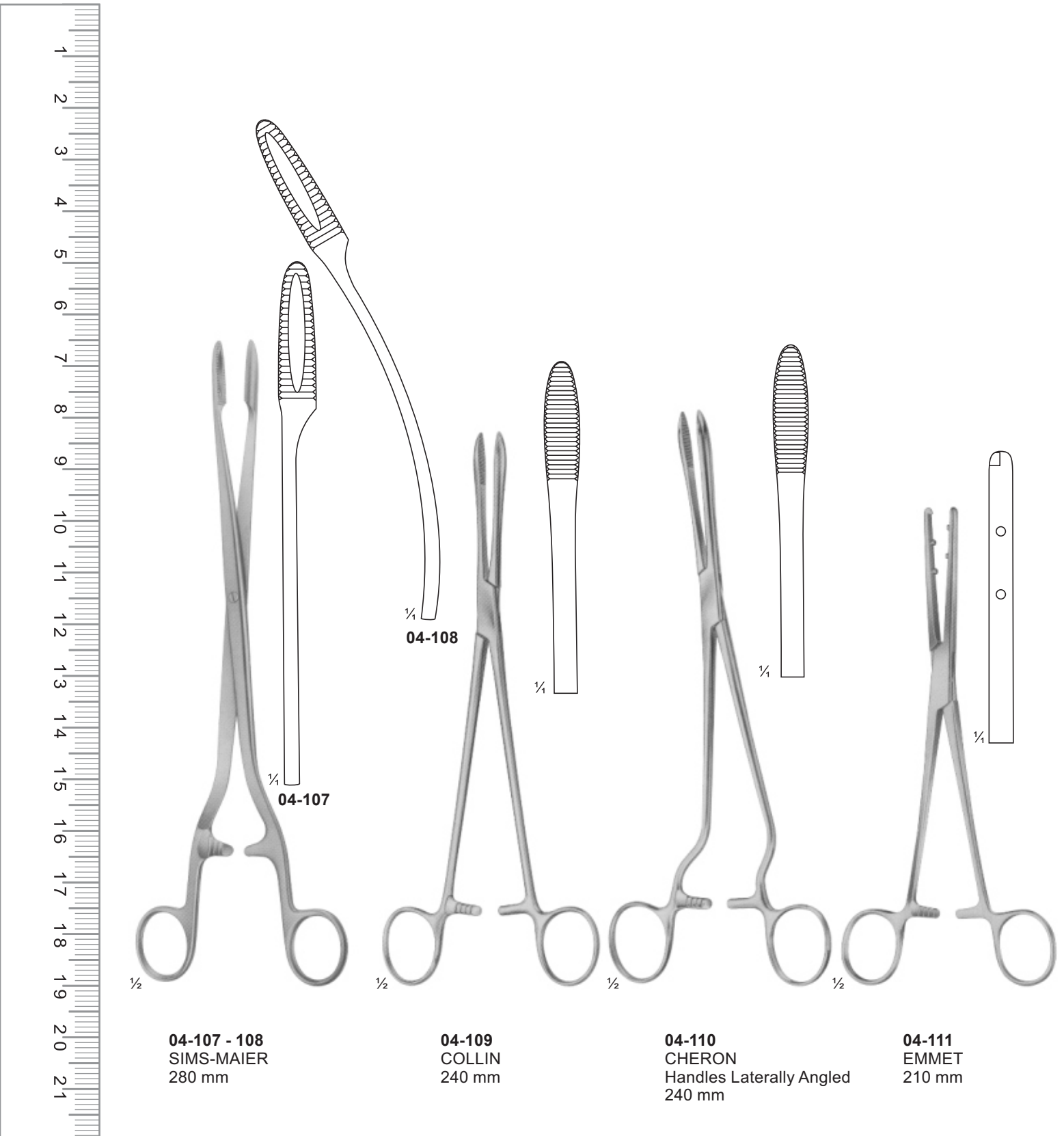

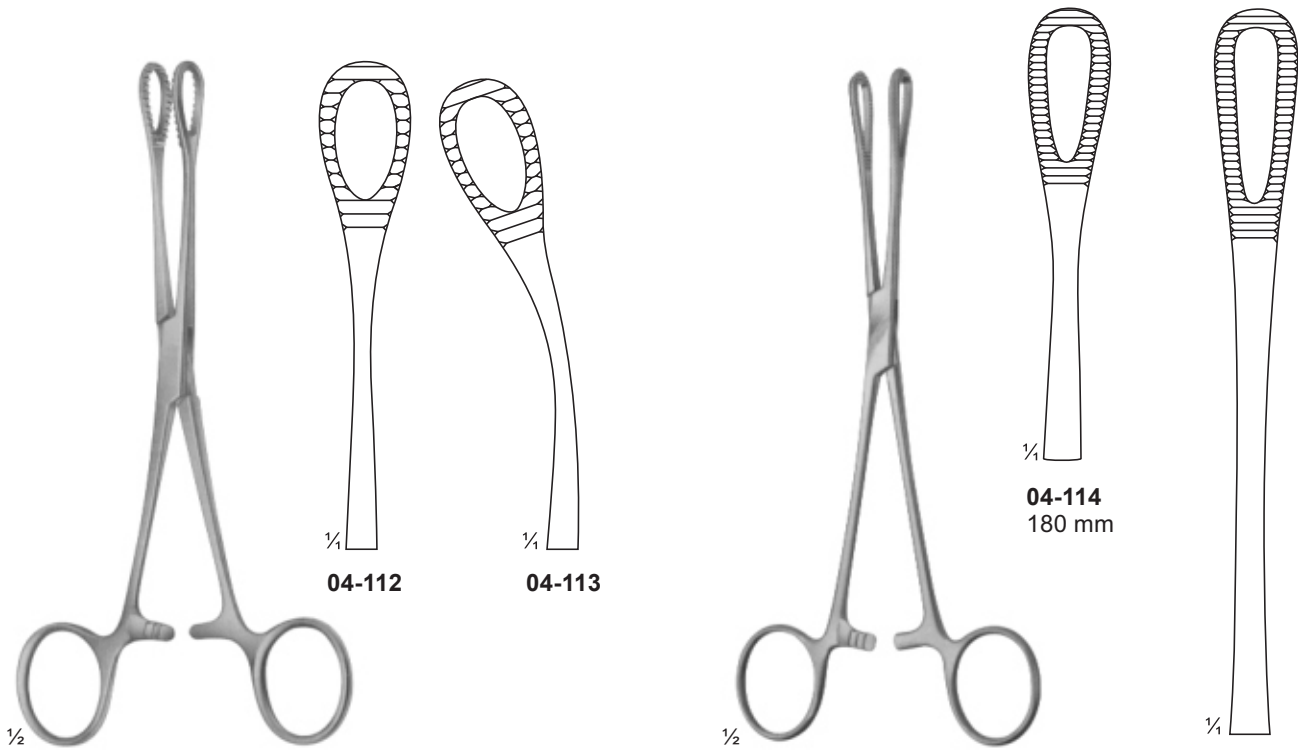

04-112 - 113
FOERSTER-BALLENGER
 180 mm

04-114 - 115
RAMPLEY

04-115
 250 mm

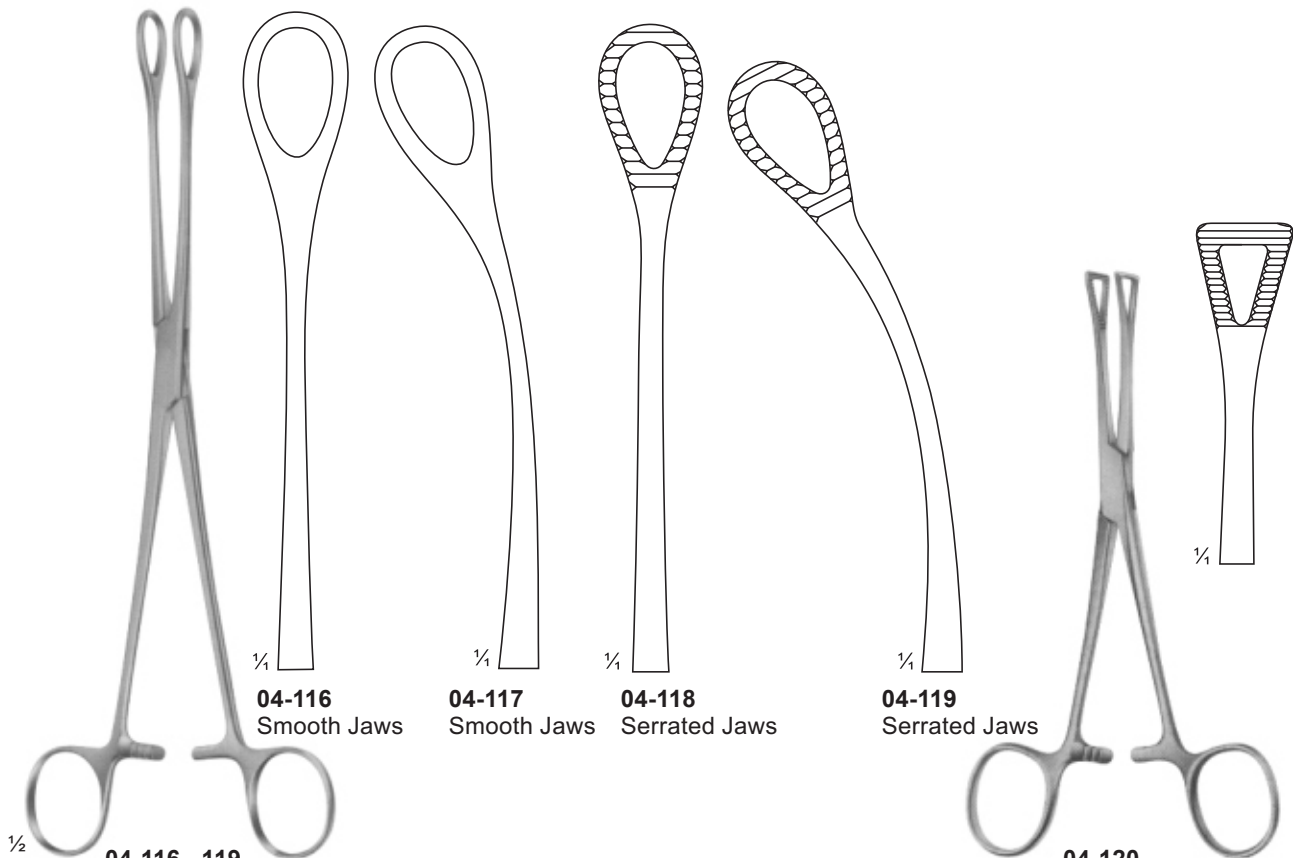

04-116 - 119
FOERSTER-BALLENGER
 240 mm

04-120
PENNINGTON
 155 mm



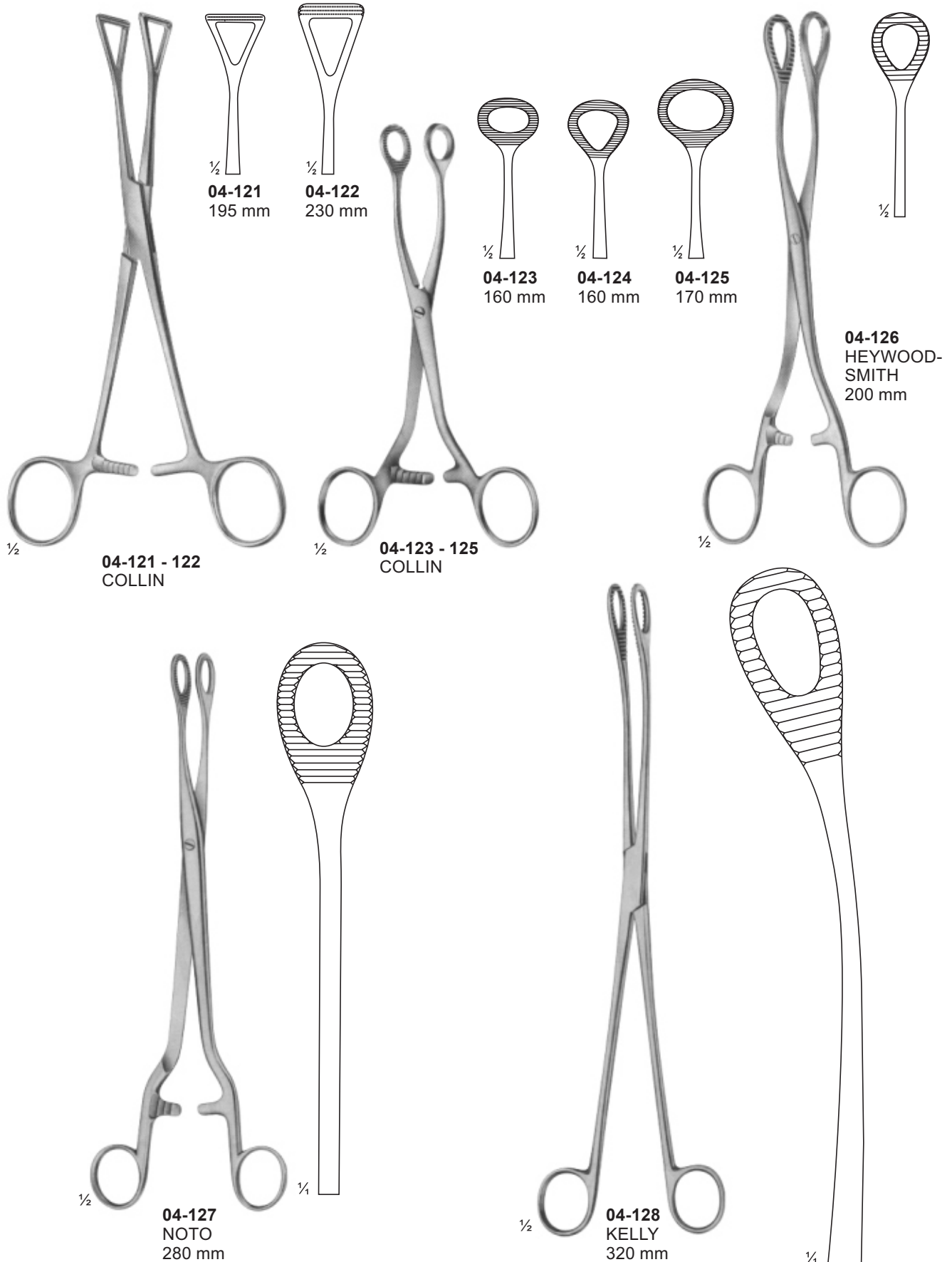

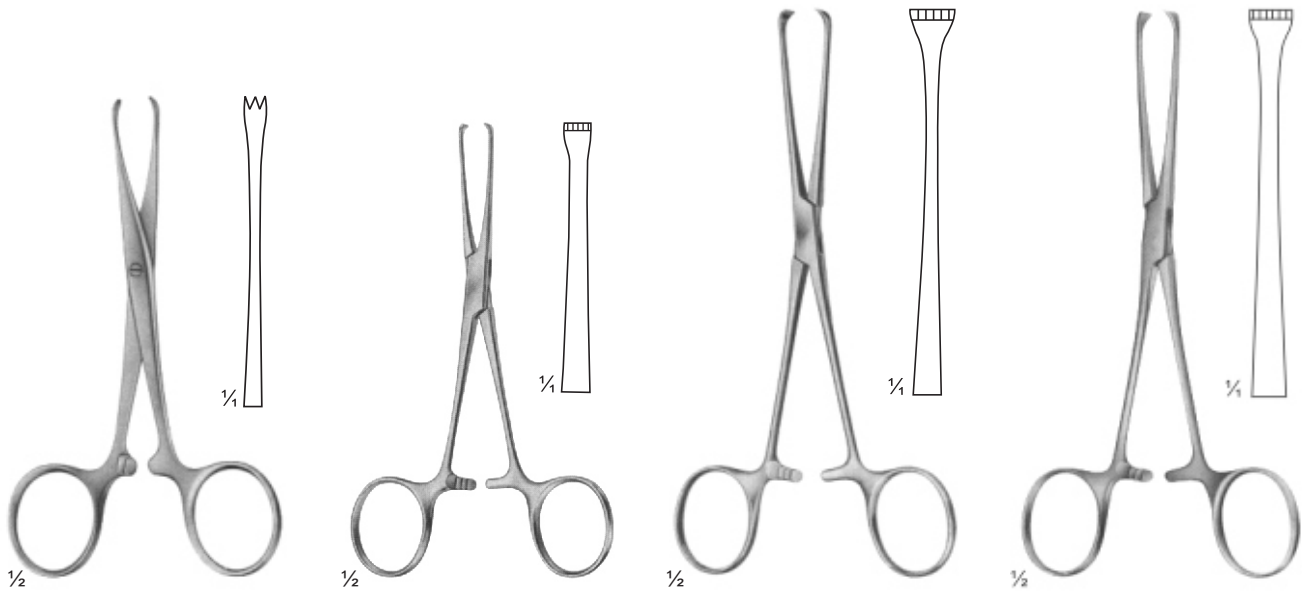

04-129
 CHAPUT
 2 x 3 teeth
 125 mm

04-130
 BABY-ALLIS
 4 x 5 teeth
 130 mm

04-131
 BOYS-ALLIS
 5 x 6 teeth
 155 mm

04-132
 ALLIS
 5 x 6 teeth
 155 mm

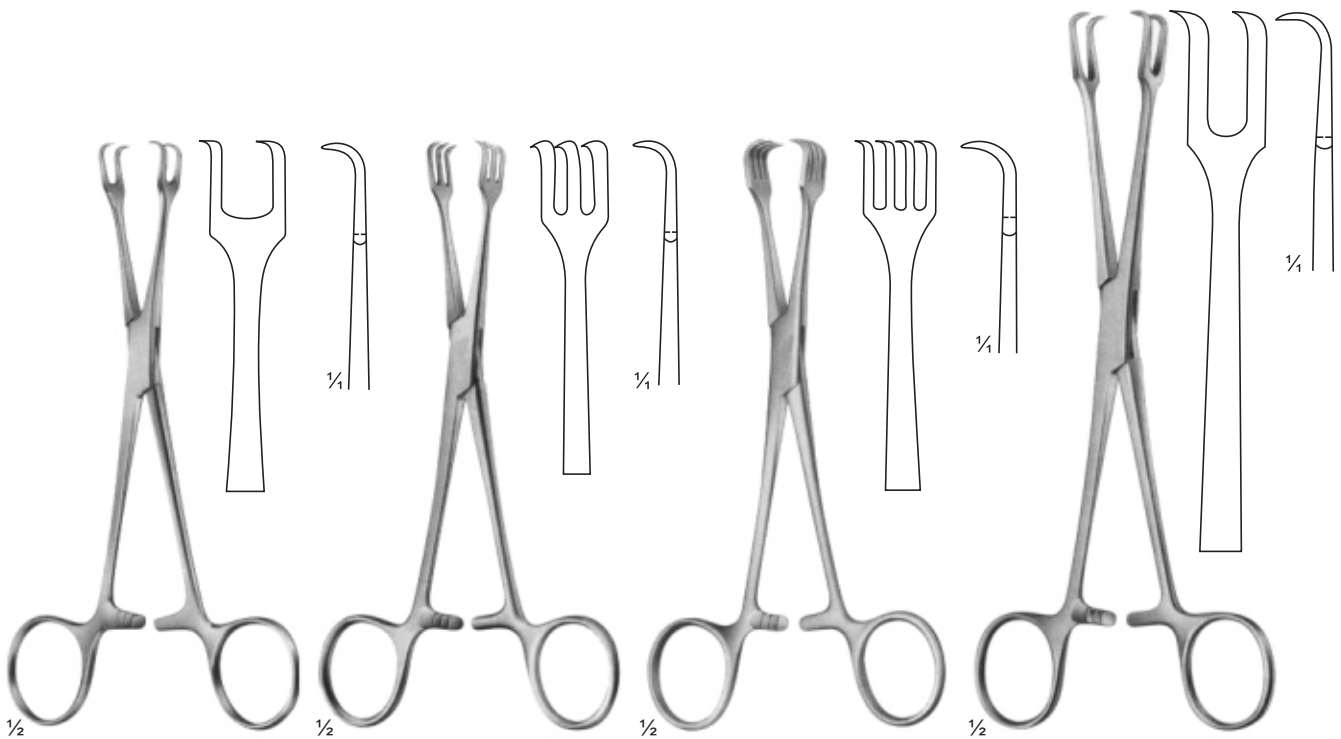

04-133
 LAHEY
 135 mm

04-134
 LAHEY
 135 mm

04-135
 BRAUN
 155 mm

04-136
 MUSEUX
 200 mm





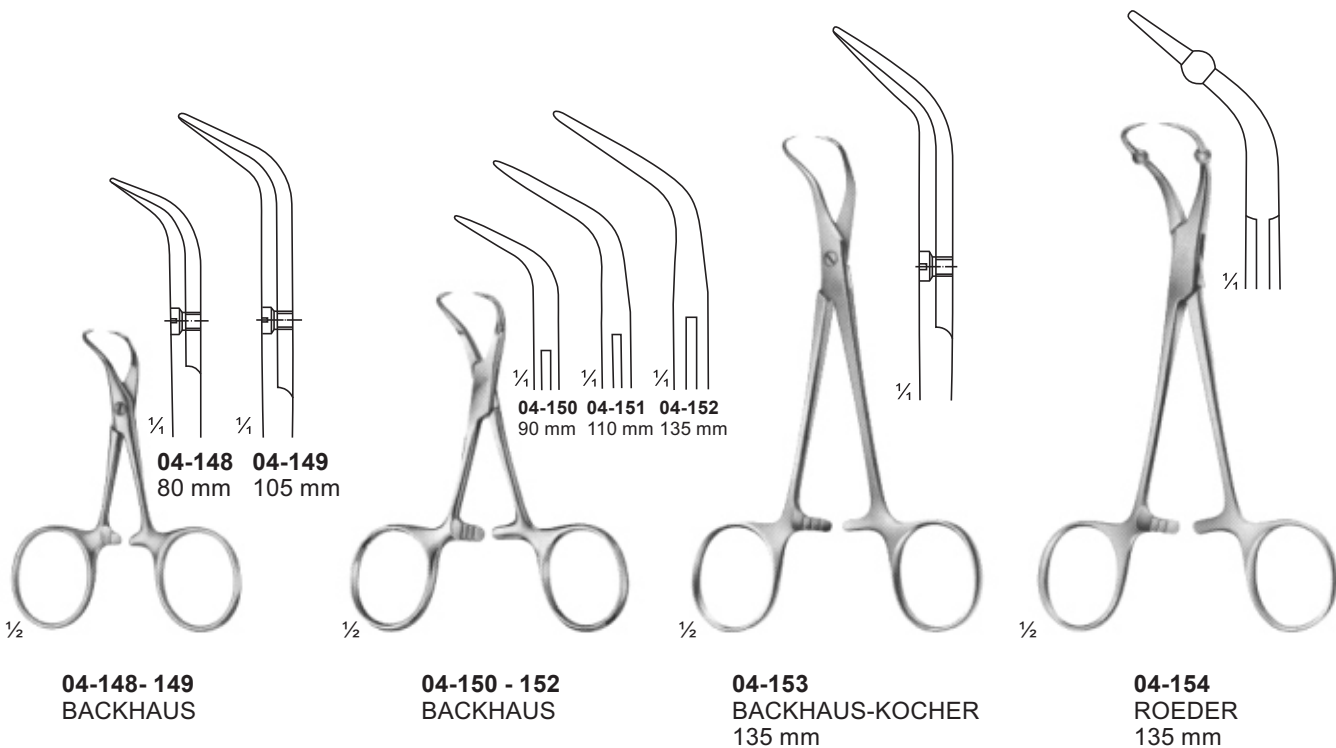
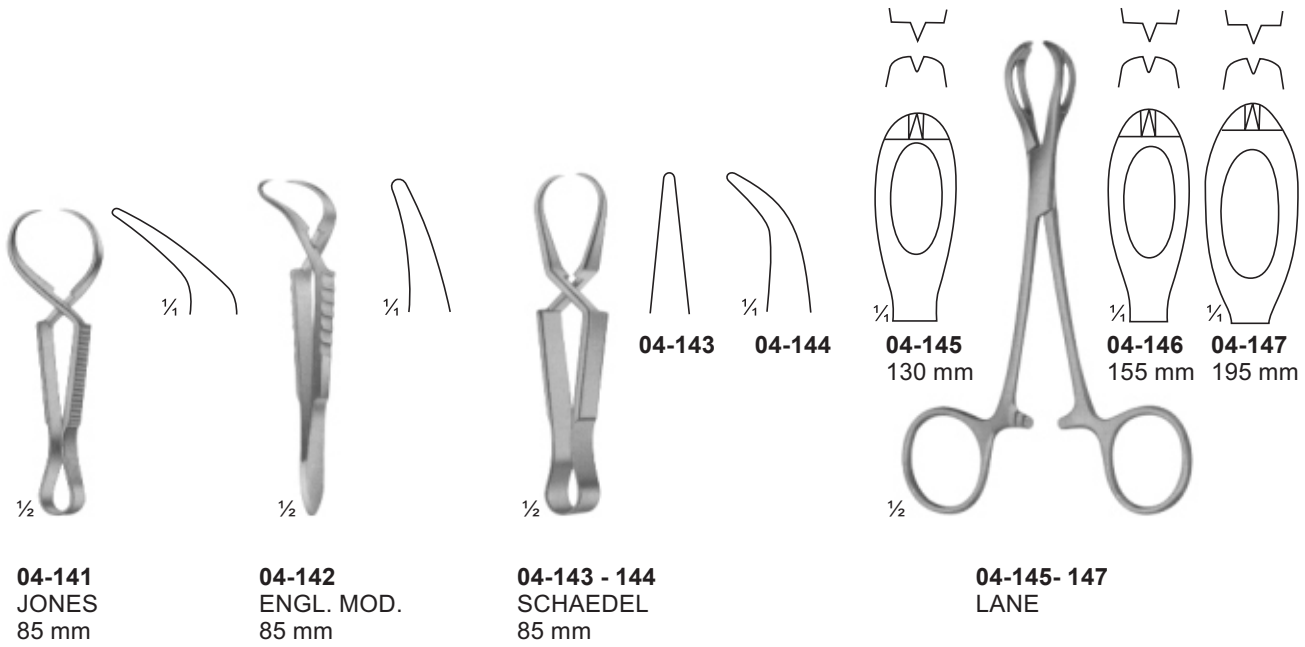

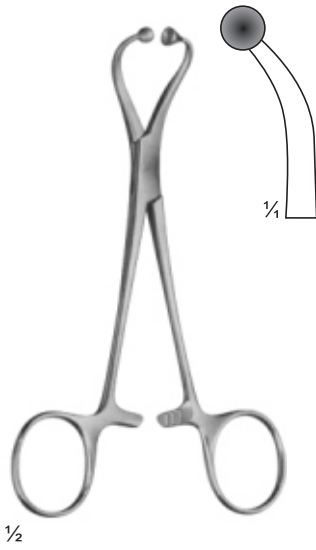

$\frac{1}{2}$
04-155
for paper cloths
140 mm

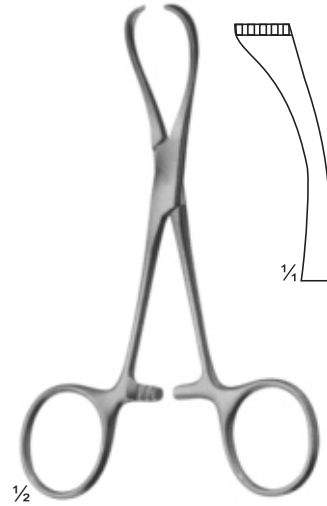

$\frac{1}{2}$
04-156
LORNA
non perforating
130 mm

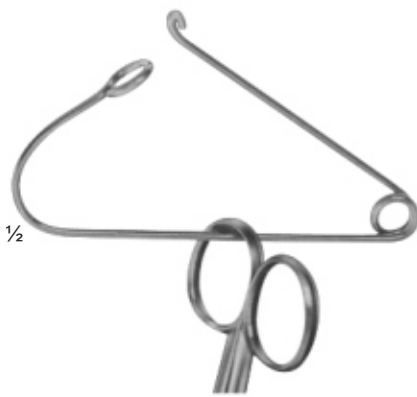

$\frac{1}{2}$
04-157
BUNT
105 mm



$\frac{1}{2}$
04-158
MAYO
140 mm

Closing Force

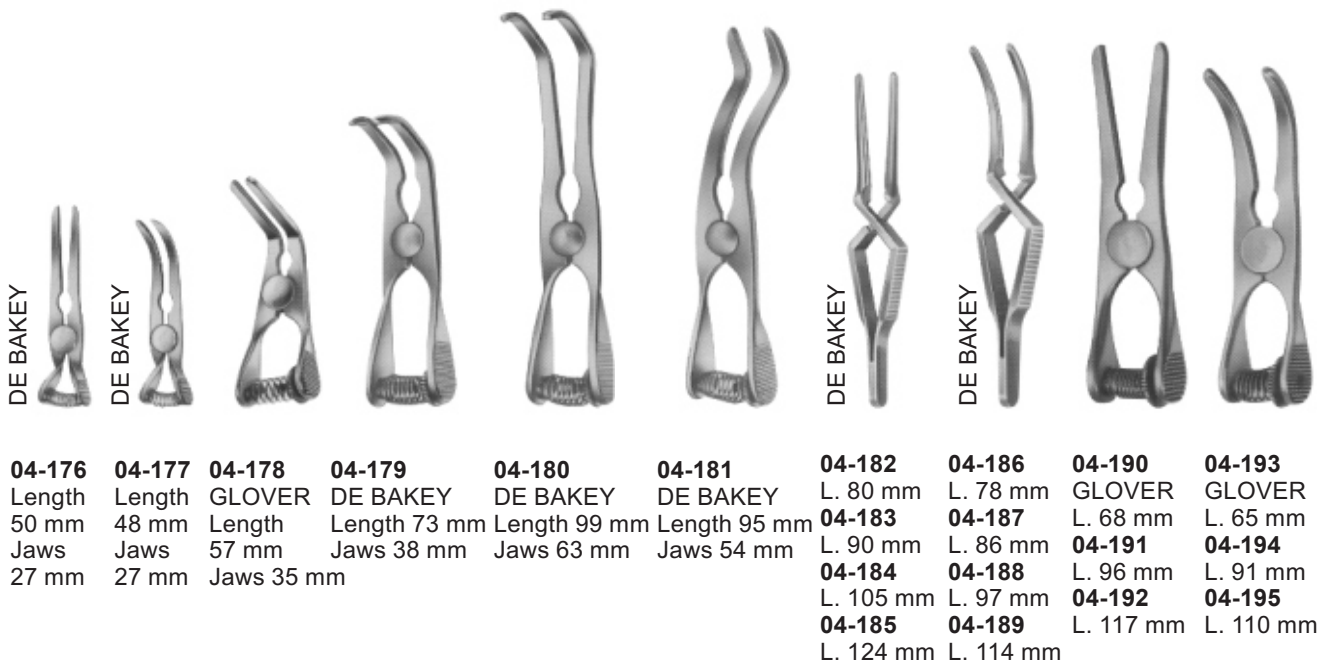
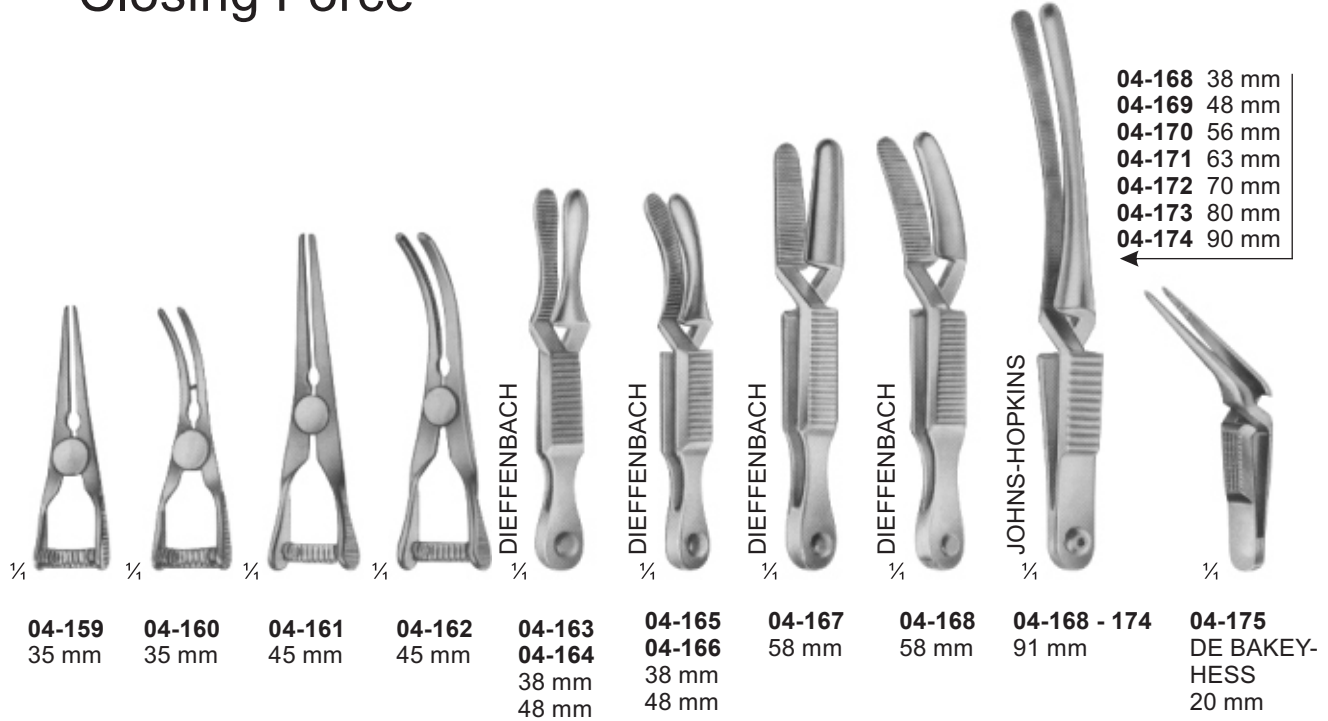

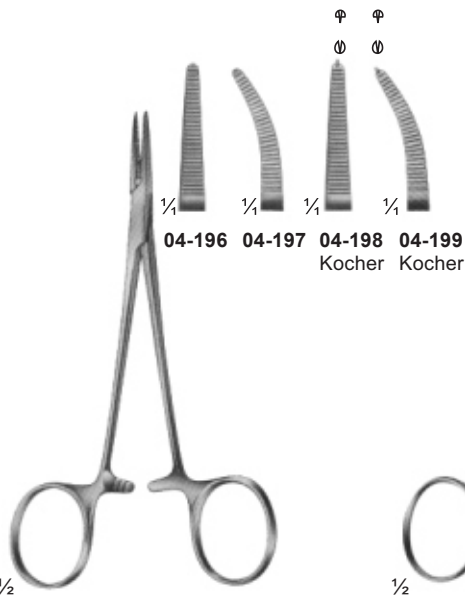

04-196 -199
HALSTED-MOSQUITO
125 mm

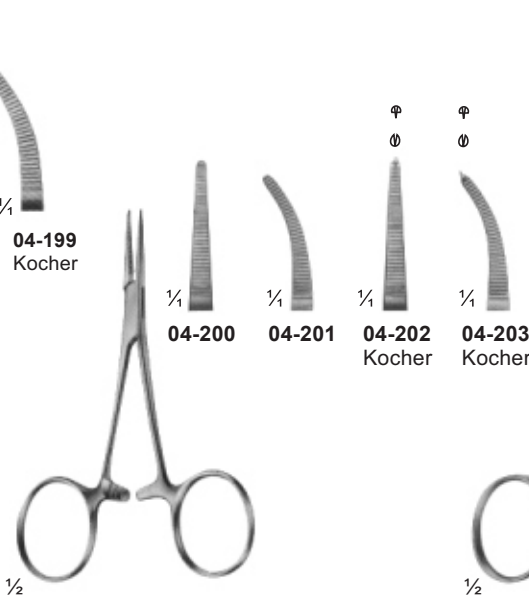

04-200 - 203
BABY-MOSQUITO
(HARTMANN)
100 mm

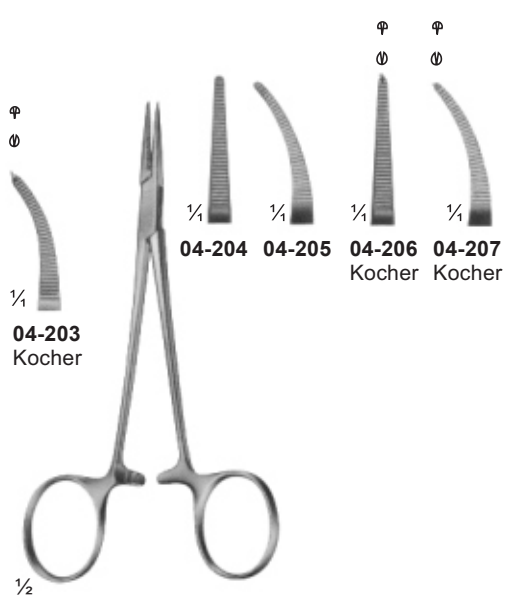

04-204 - 207
MICRO-HALSTED
125 mm



04-208 - 209
PROVIDENCE-HOSPITAL
140 mm



04-210 - 211
KELLY
140 mm

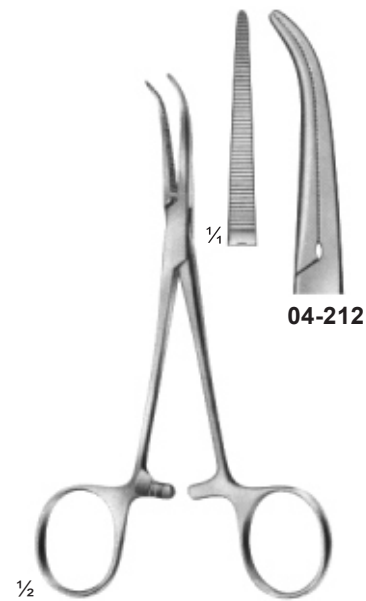

04-212
DANDY
Curved sideways
140 mm

Delicate Haemostatic Forceps
Zarte Arterienklemme
Delicadas Pinzas Hemostáticas

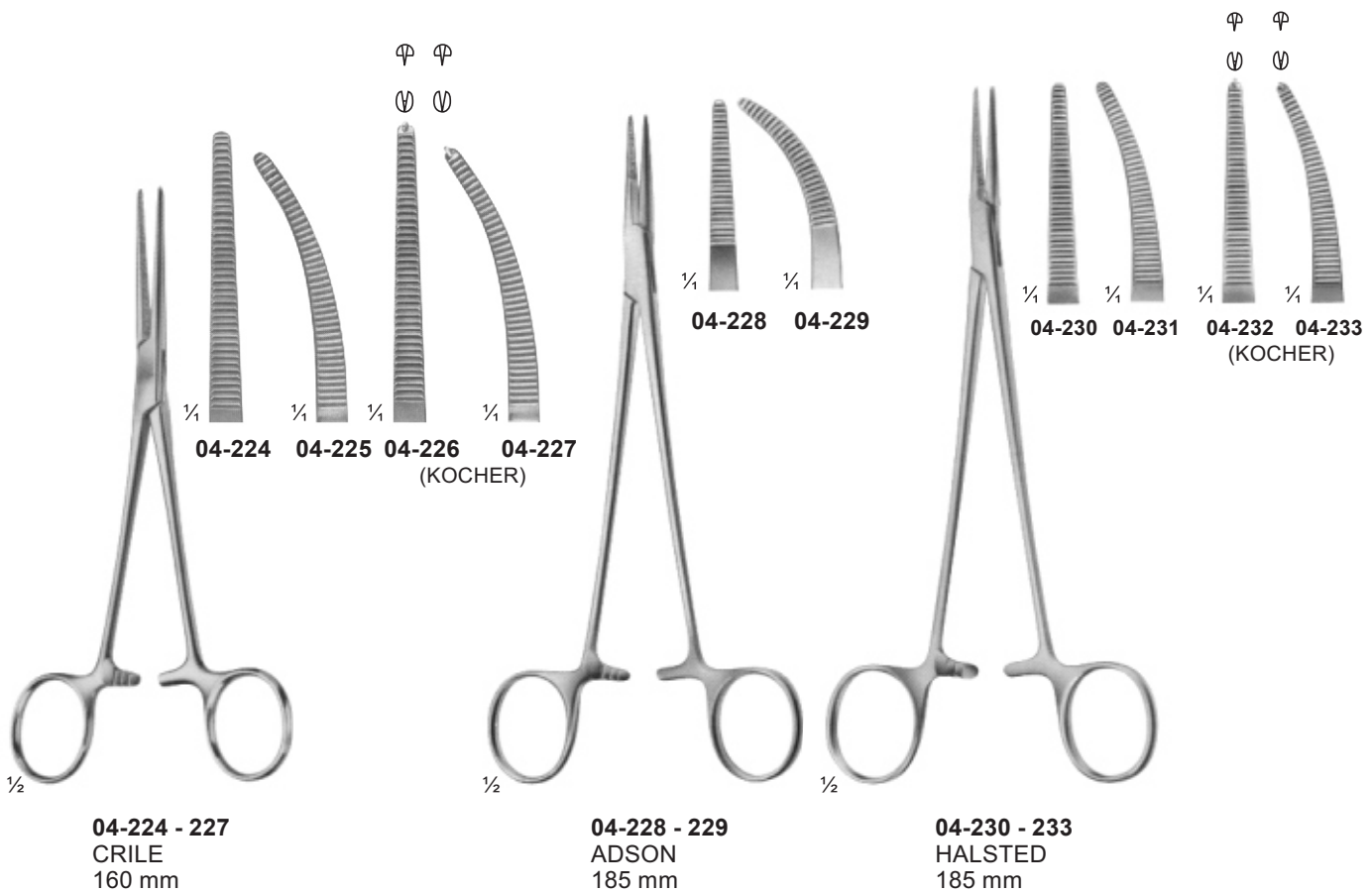
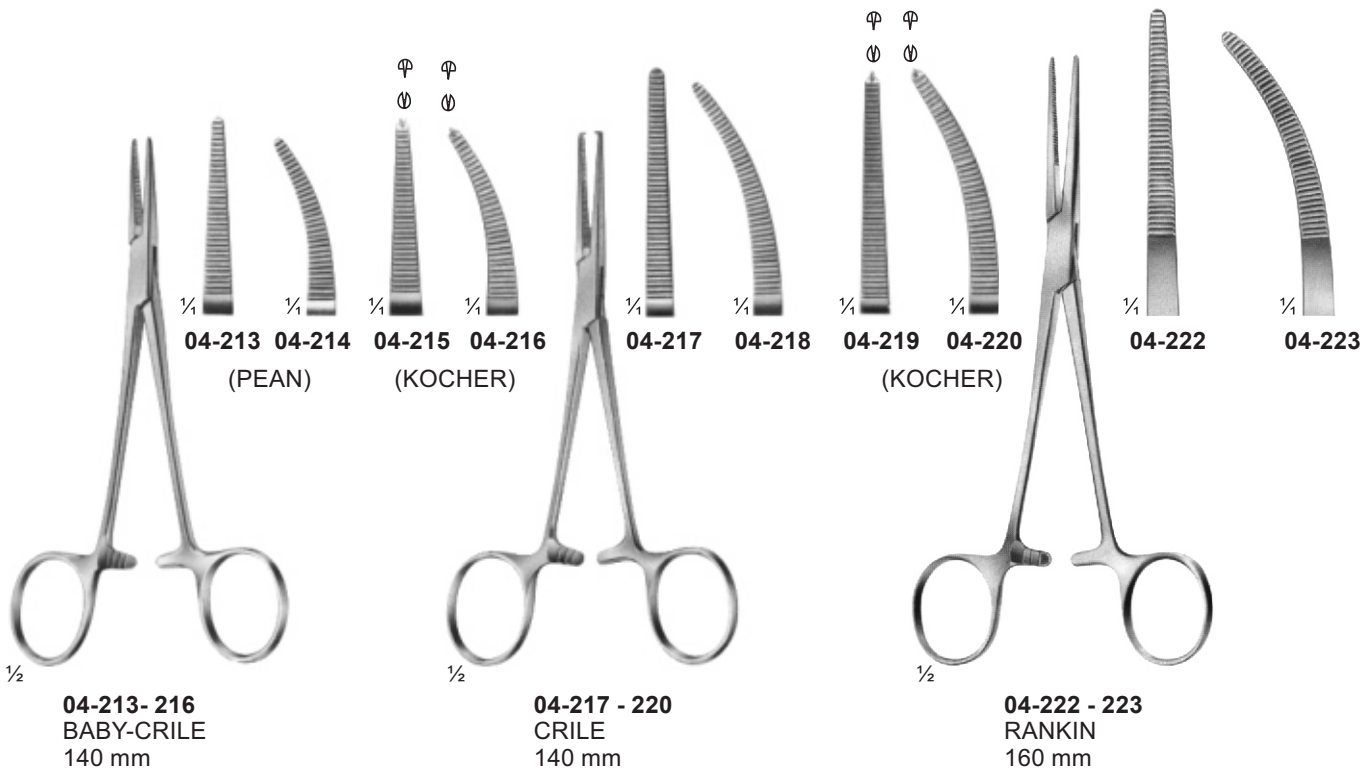

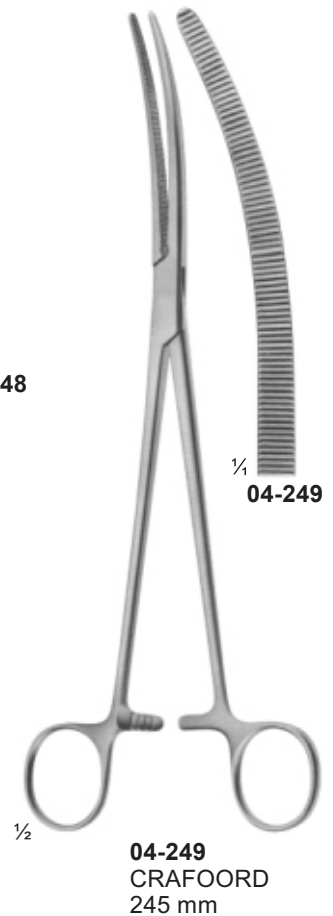
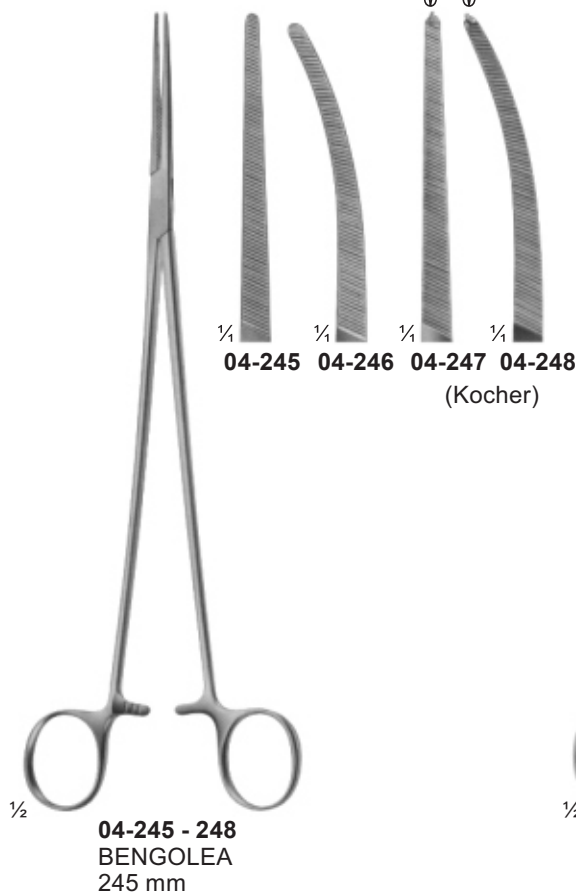
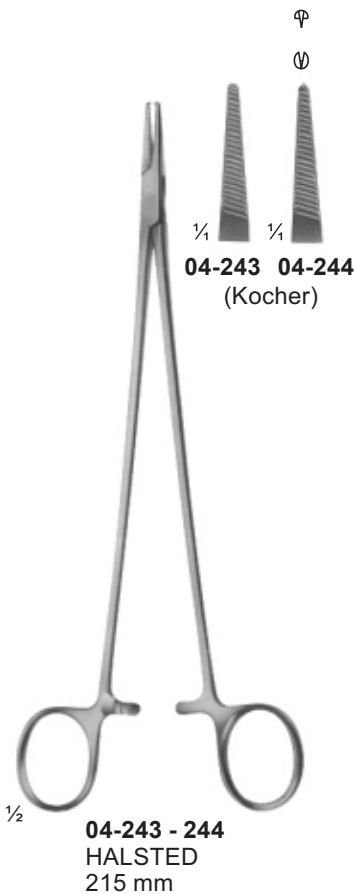
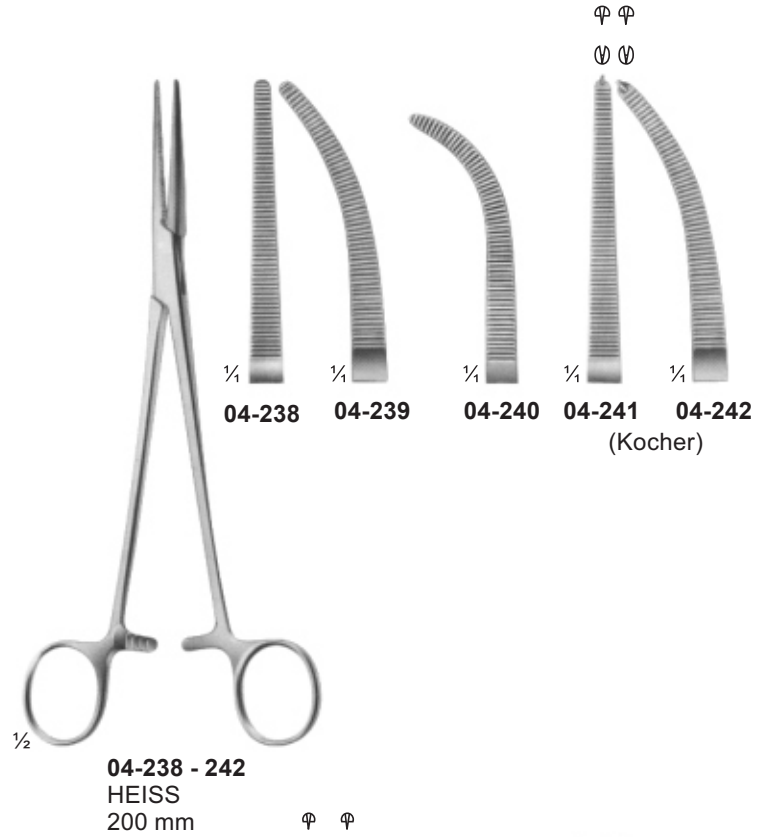
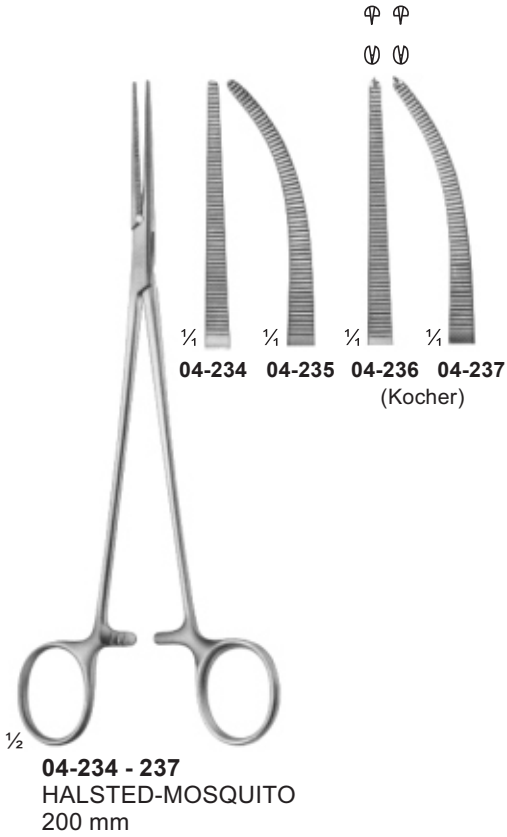

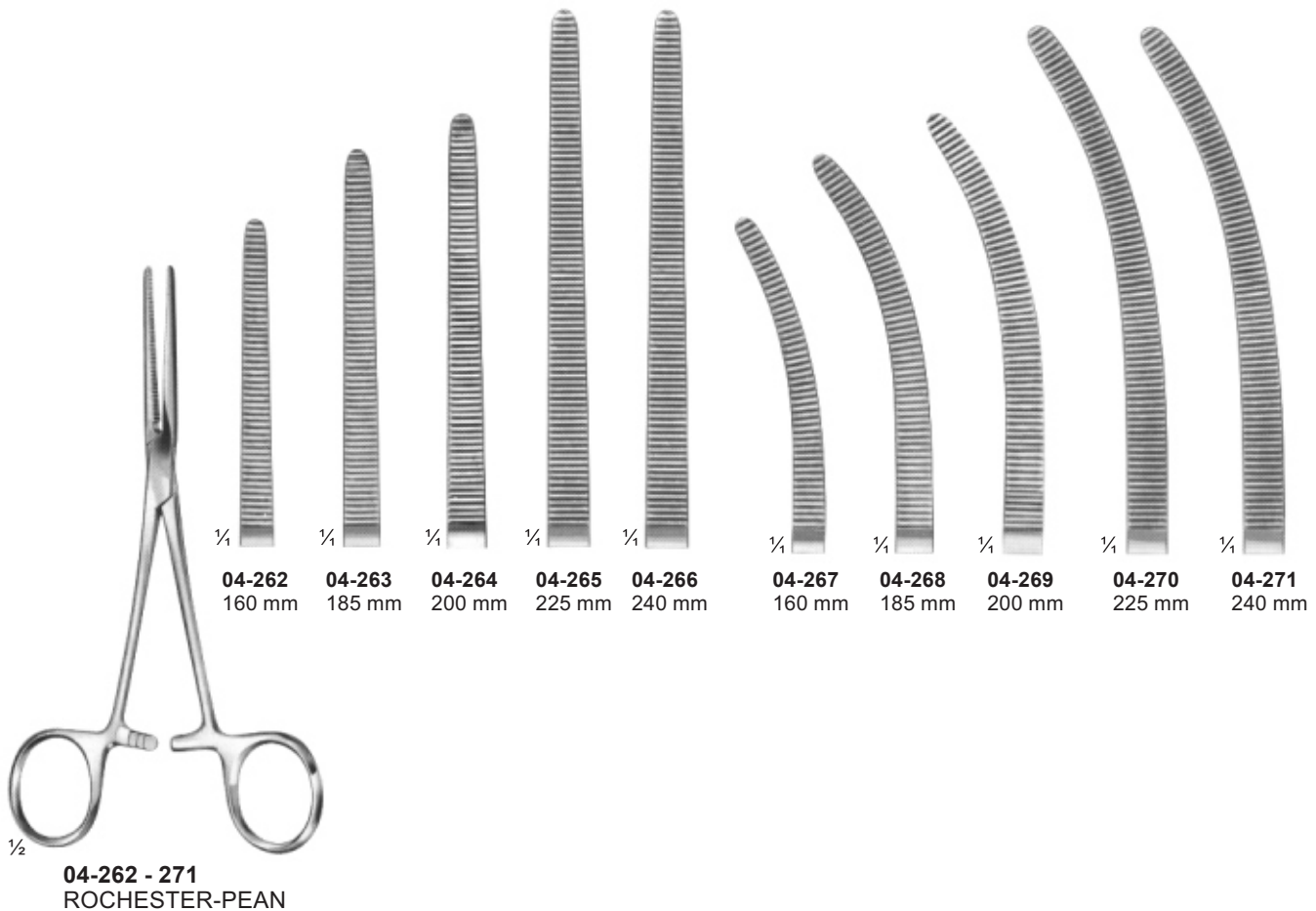
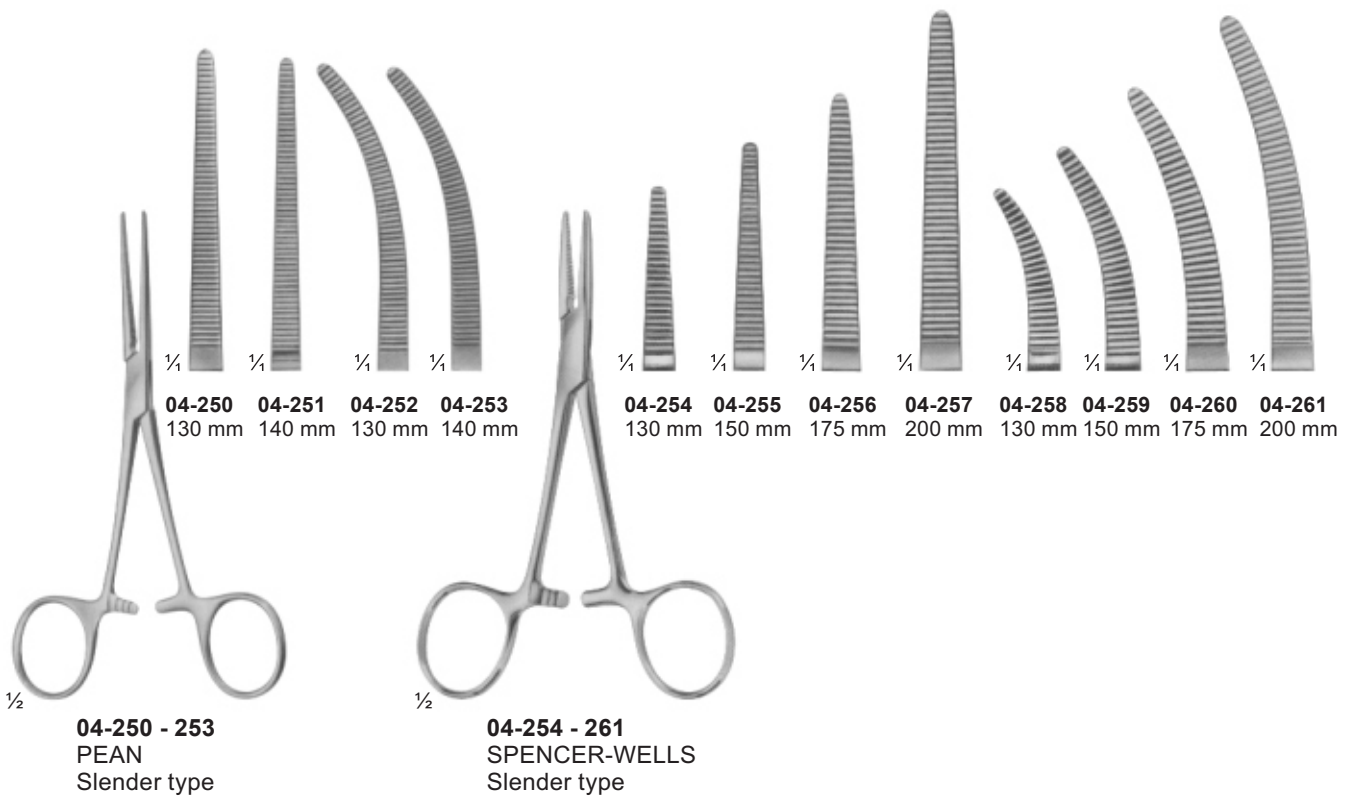

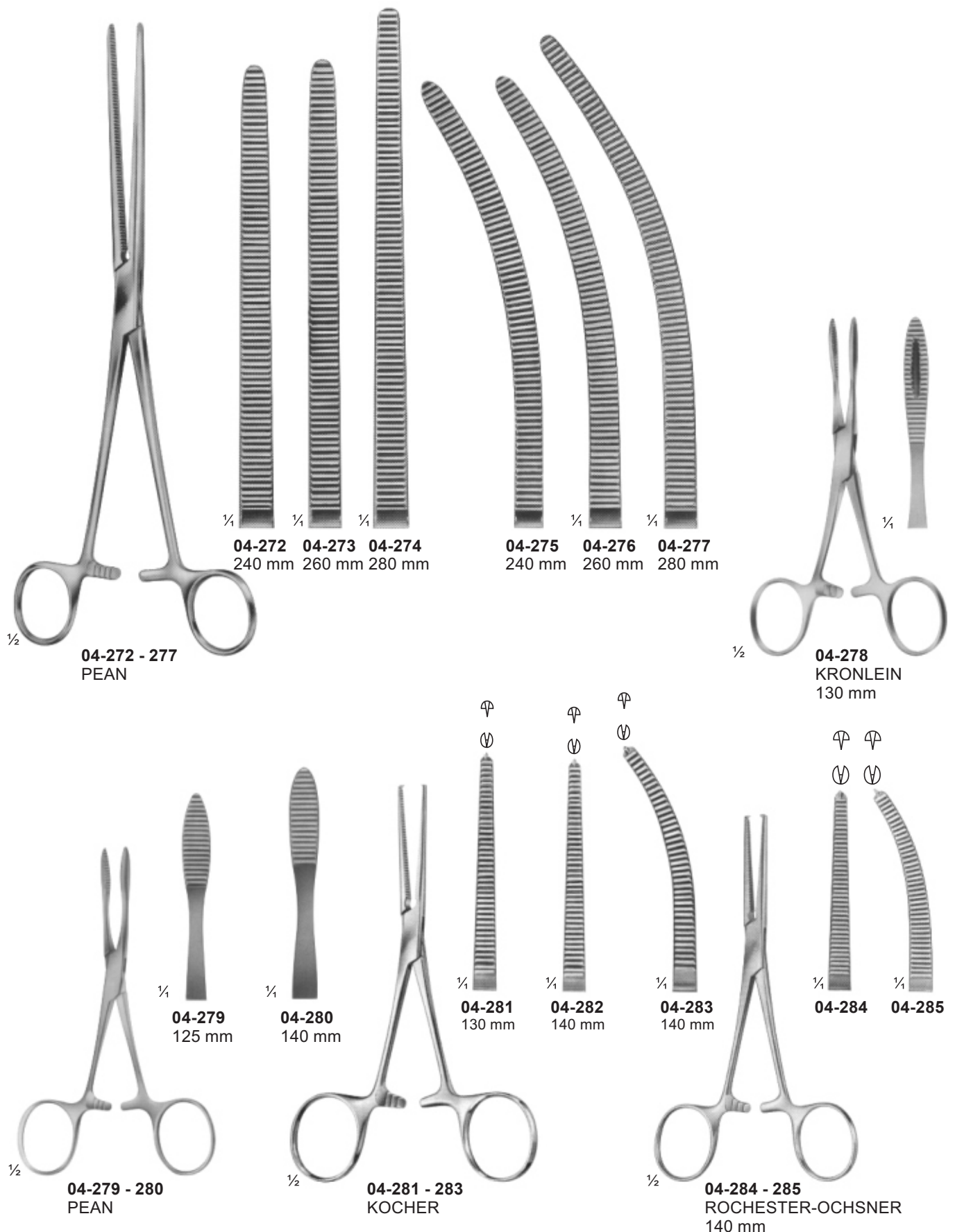



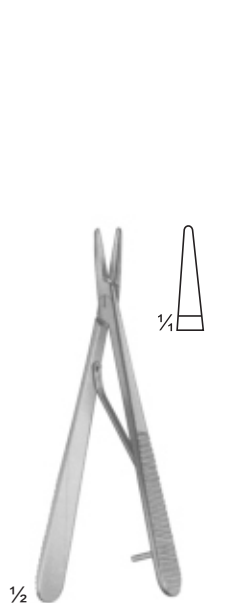







 <p>1/2</p>	 <p>1/4 1/4</p>	 <p>1/4</p>	 <p>1/4</p>	 <p>1/4</p>	 <p>1/4</p>	 <p>1/4</p>
<p>04-394 ROHRSCNEIDER With copper inserts 100 mm</p>	<p>04-395 KALT With catch 135 mm</p>	<p>04-396 ARRUGA With catch 135 mm</p>	<p>04-397 - 398 CASTROVIEJO With catch 145 mm</p>	<p>04-399 - 400 CASTROVIEJO With Catch 160 mm</p>		
 <p>1/4</p>	 <p>1/4</p>	 <p>1/4</p>	 <p>1/4</p>	 <p>1/4</p>	 <p>1/4</p>	 <p>1/4</p>
<p>04-401 - 402 Without catch 185 mm</p>	<p>04-403 - 404 JACOBSON 185 mm</p>	<p>04-405 Without catch 195 mm</p>	<p>04-406 - 407 YASARGIL With catch 200 mm</p>			



04-408
115 mm



04-409
135 mm

$\frac{1}{2}$
04-408 - 409
 BARRAQUER
 Without catch



$\frac{1}{4}$
04-410



$\frac{1}{4}$
04-411

$\frac{1}{2}$
04-410 - 411
 BARRAQUER
 Without catch
 120 mm



$\frac{1}{4}$
04-412



$\frac{1}{4}$
04-413

$\frac{1}{2}$
04-412 - 413
 BARRAQUER
 With catch
 120 mm



$\frac{1}{4}$
04-414



$\frac{1}{4}$
04-415

$\frac{1}{2}$
04-414 - 415
 BARRAQUER
 With Catch
 150 mm

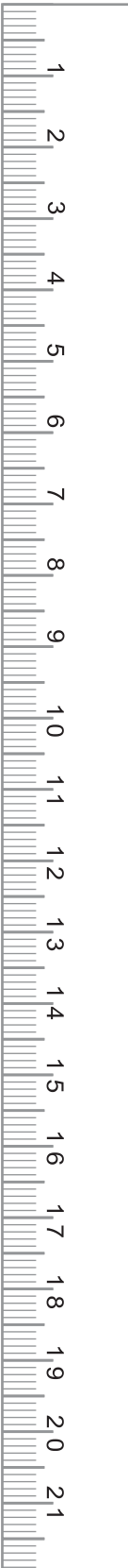



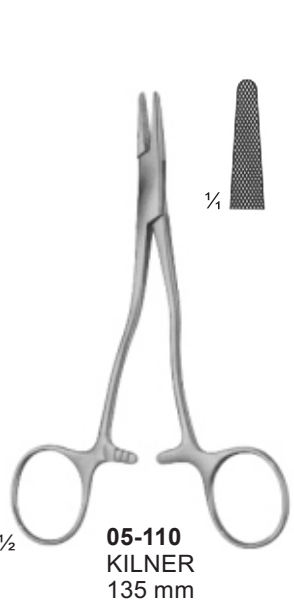
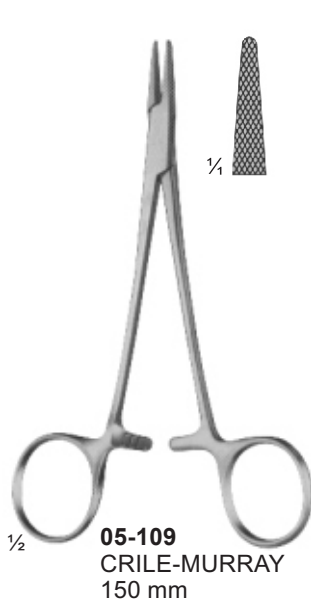
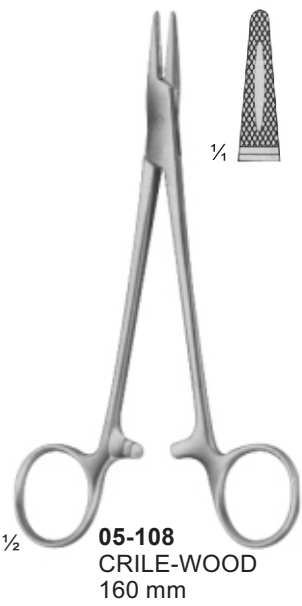
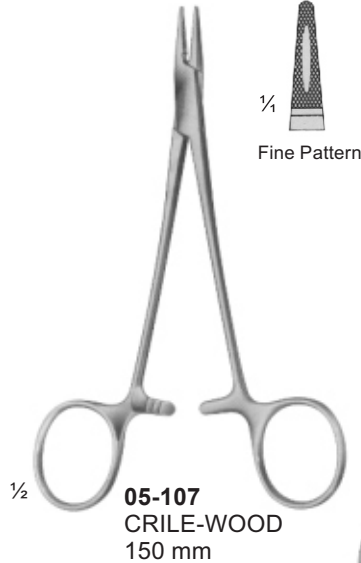
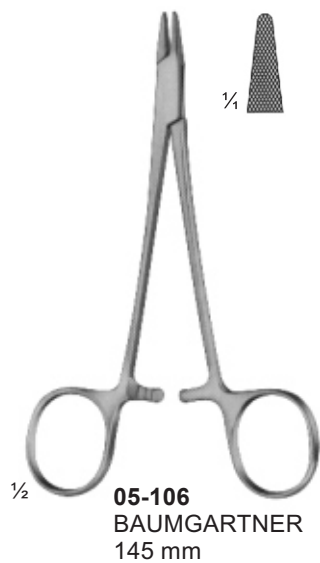
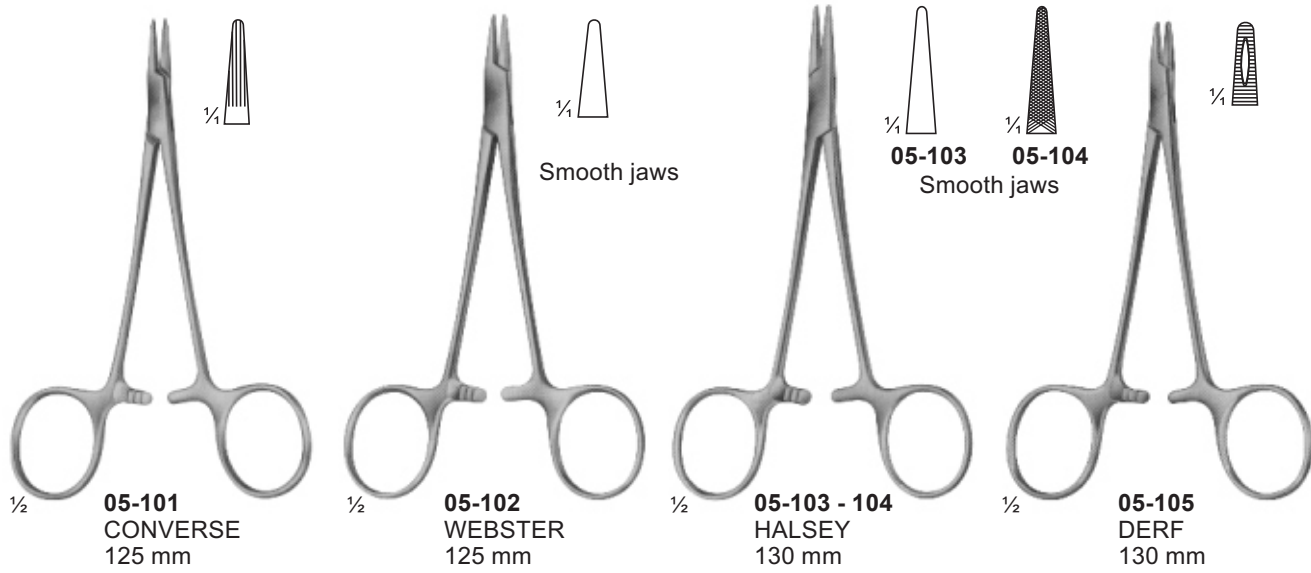

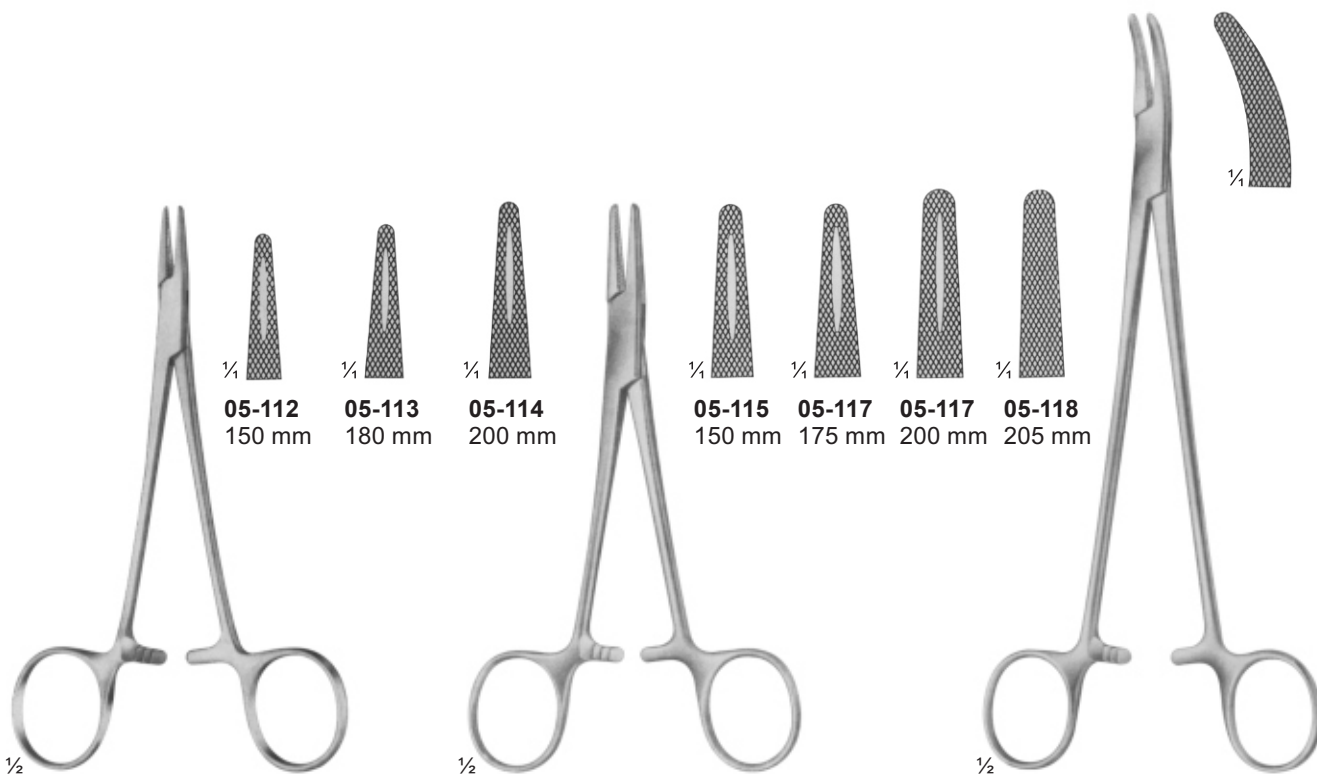
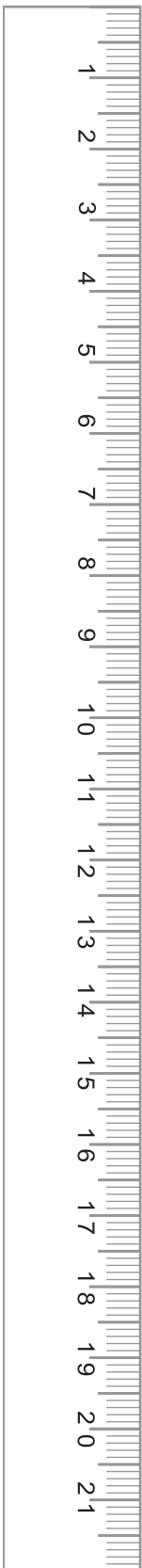

05-112 - 114
MAYO-HEGAR
Medium fine patterns

05-115 - 118
HEGAR
Heavy Patterns

05-119
HEANEY (HEGAR)
200 mm



05-120
JAMESON
230 mm

05-121
WANGENSTEEN
275 mm

05-122
MASSON
265 mm

05-123
MASSON-LUETHY
255 mm

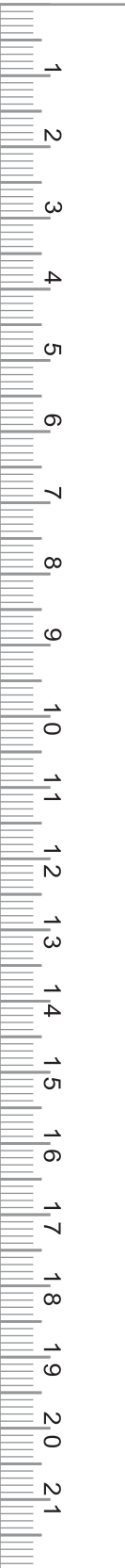
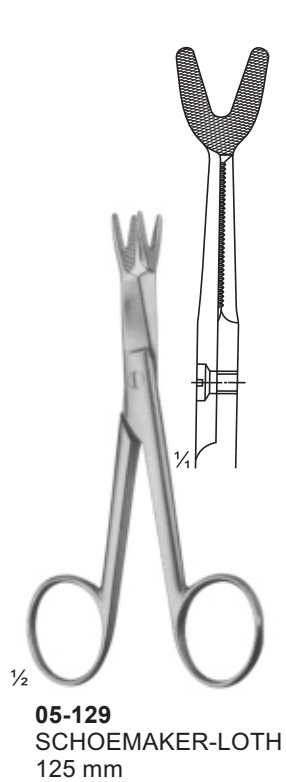
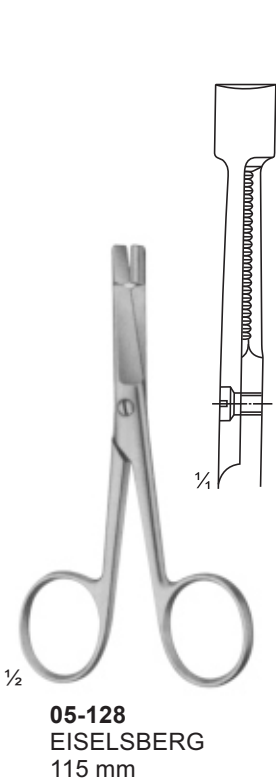
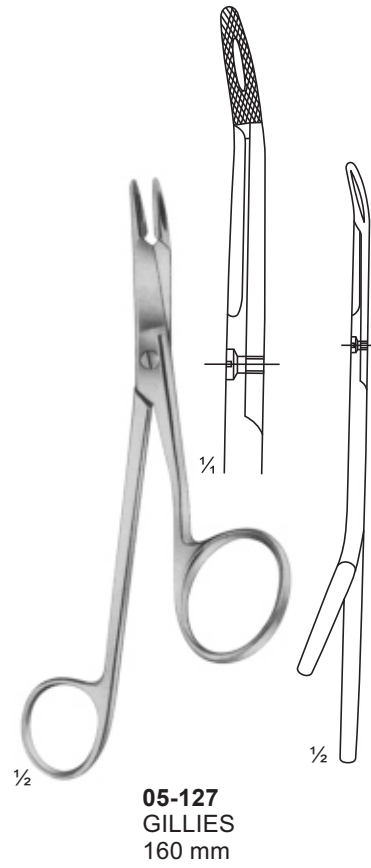
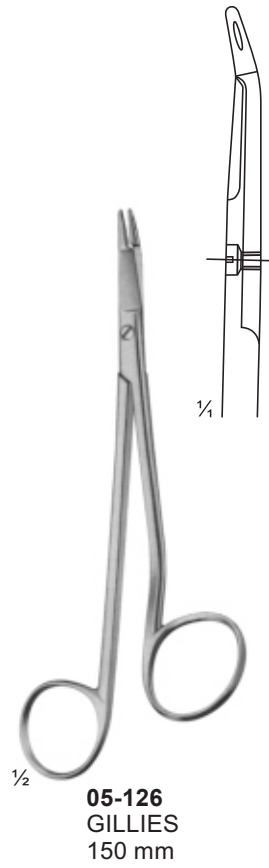
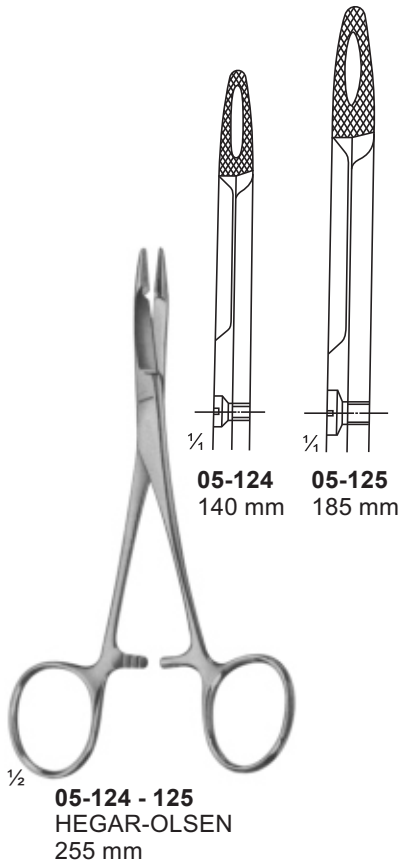

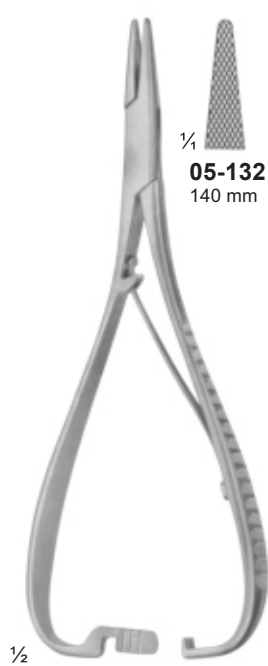

05-132 140 mm
05-133 170 mm
05-134 200 mm

05-132 - 134
MATHIEU

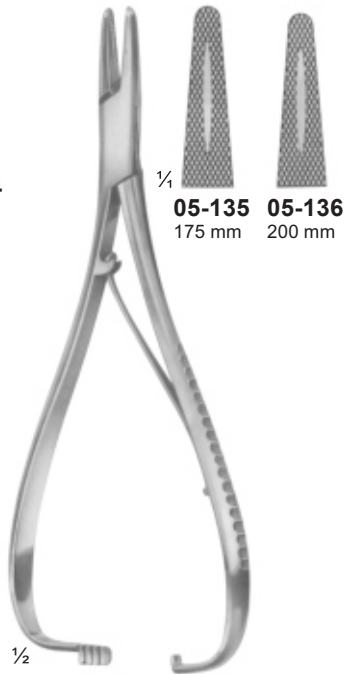

05-135 175 mm
05-136 200 mm

05-135 - 136
MATHIEU-STILLE
Very heavy models



05-137
BOYNTON
125 mm

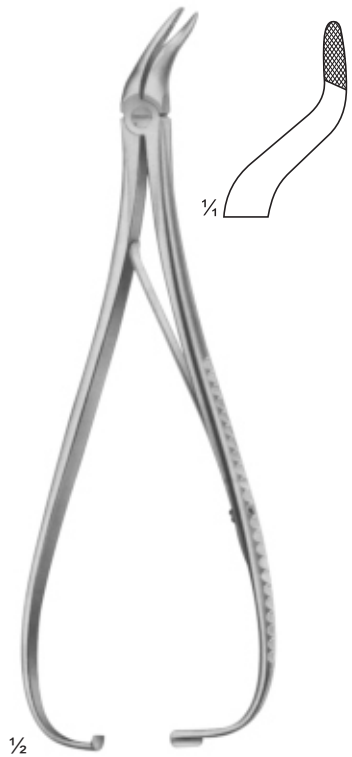

05-138
EISELSBERG-MATHIEU
For palate suture
195 mm



05-139
MATHIEU-KOCHER



05-140
BOYNTON
125 mm



05-141
MILLIN
Ligature holding forceps
245 mm

Suture Instruments - Reverdin Needles
Naht-instrumente - Reverdin Needles
- Agujas De Sutura Instrumentos Reverdin



05-142 05-143 05-144 05-145

05-142 - 145
REVERDIN
140 mm



05-146 05-147 05-148 05-149 05-151 05-152 05-153 05-154

05-146 - 149
REVERDIN
195 mm

05-150 - 154
REVERDIN
220 mm



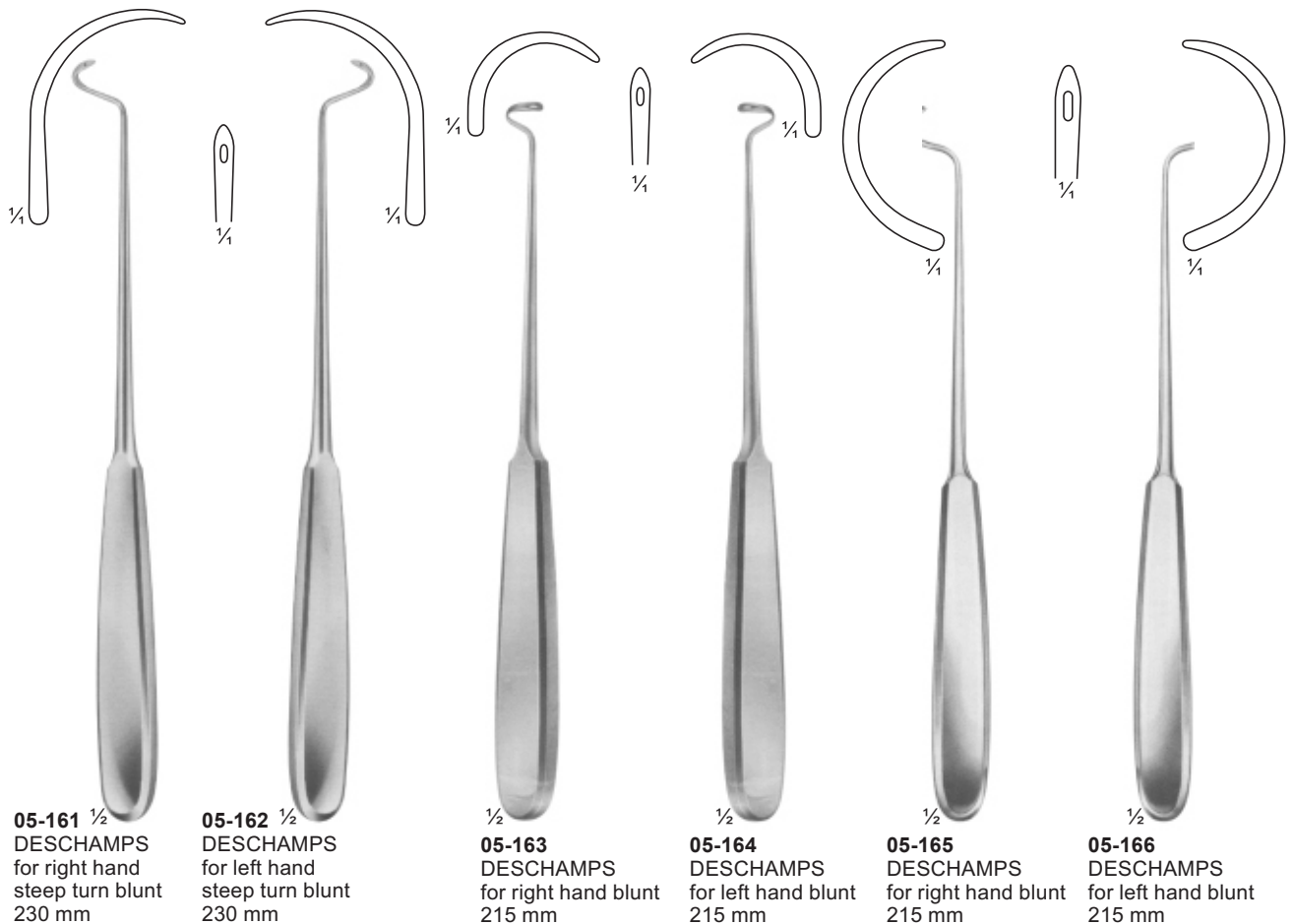
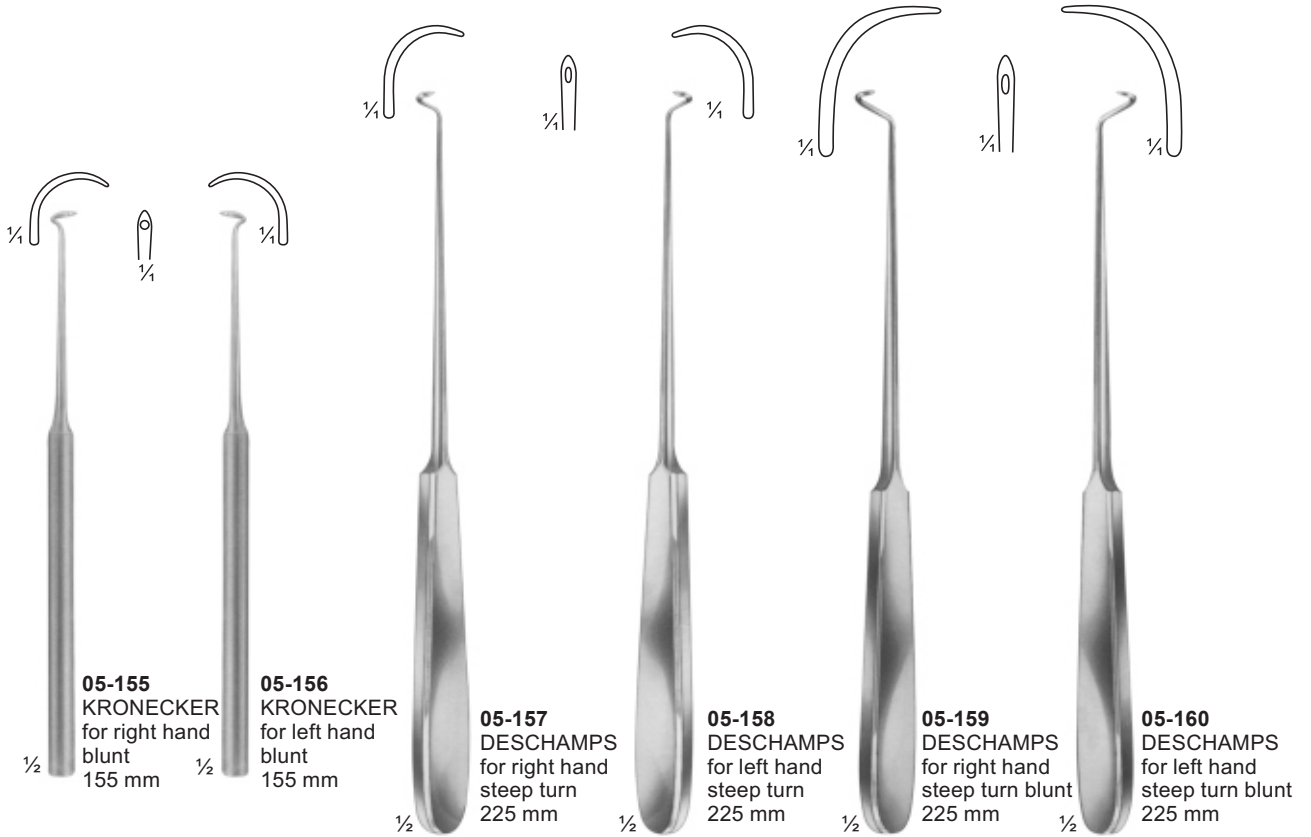

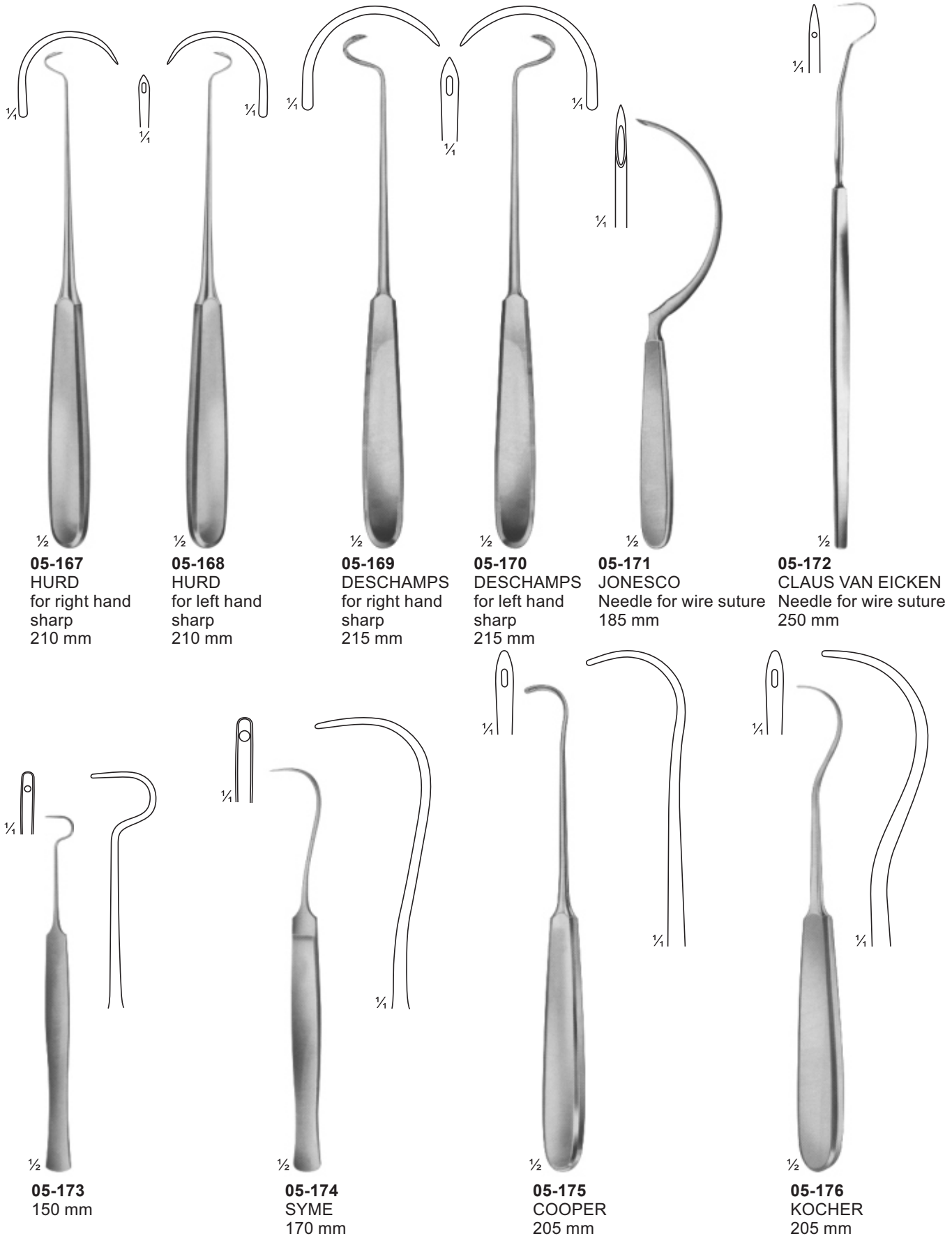

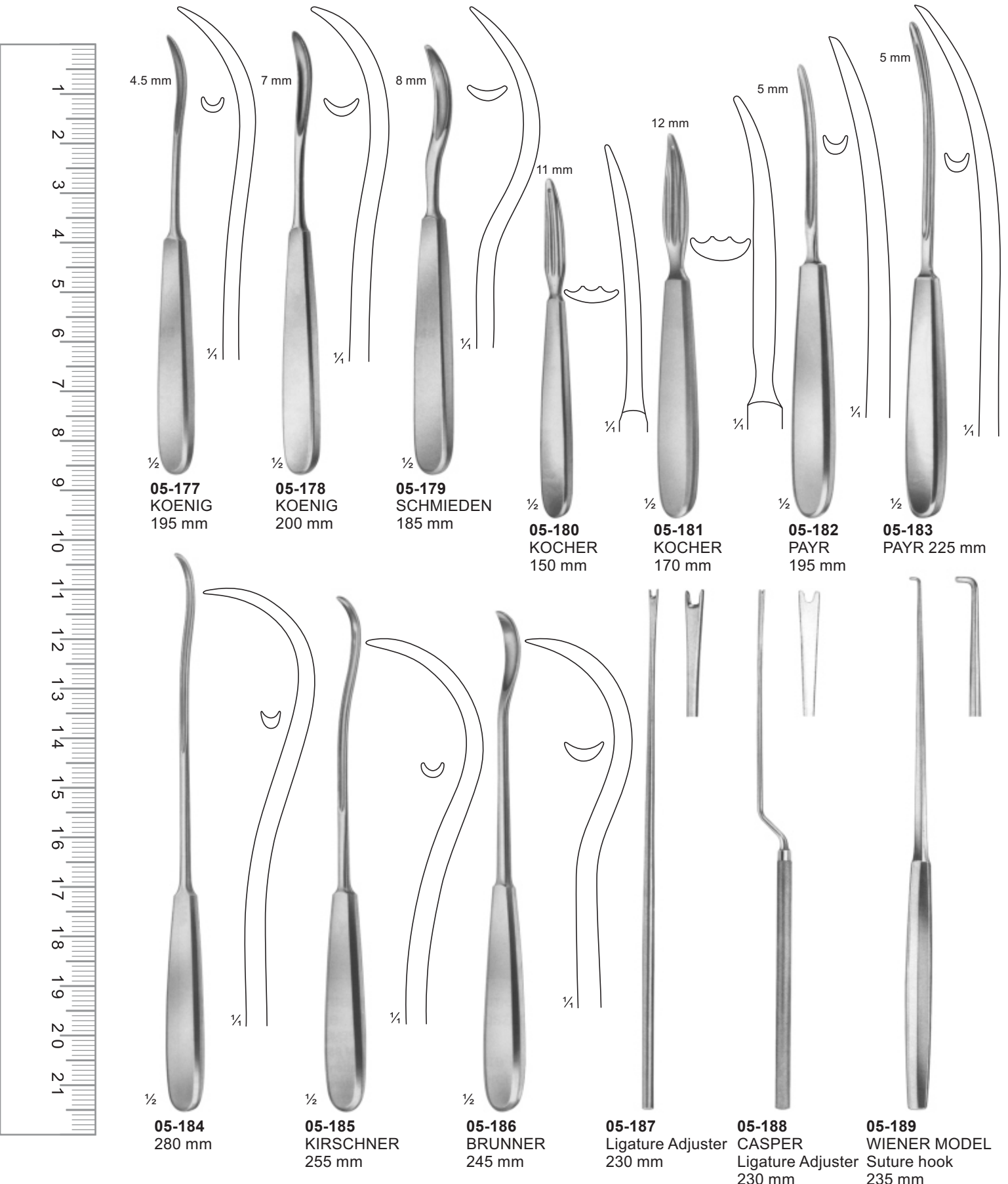

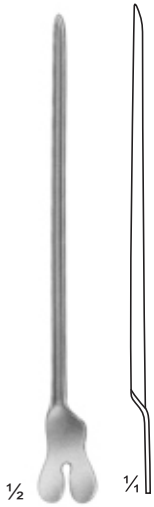

05-190 130 mm
05-191 145 mm
05-192 160 mm
Directors

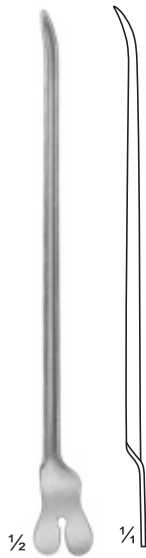

05-193
DOYEN
145 mm
Directors

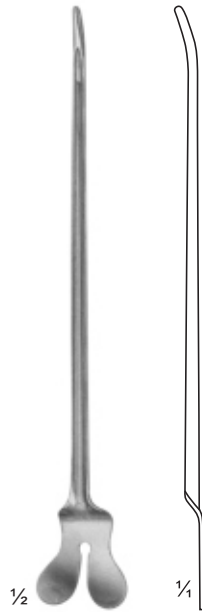

05-194
NELATON
160 mm
Directors

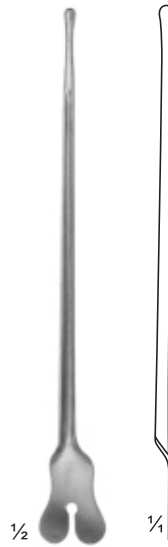

05-195
Director with tip
Diam. Of tip 3,3 mm
140 mm

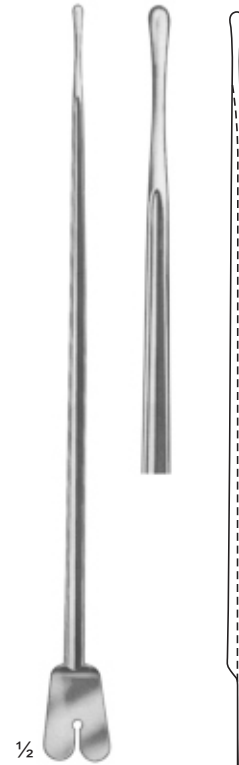

05-196
BRODIE
Director with tip,
Diam. Of tip 3,5 mm
200 mm



05-197
2,5 mm
05-198
2,5 mm
05-199
3,0 mm



1/2

05-197 145 mm
05-198 160 mm
05-199 200 mm
Probes with eye

1,5 mm



1/2

05-200
Myrtle leaf probe
145 mm

2,0 mm



1/2

05-201 130 mm
05-202 145 mm
05-203 160 mm
05-204 180 mm
05-205 200 mm



1/2

05-206
Probes



1/2

05-207
Double ended probe,
malleable, diam. of tips
3 mm with hole
190 mm



05-208
Double ended probes,
tin, malleable,
diam. of tips
3,5 mm with hole
250 mm, 300 mm



1/4

05-209
Double ended probes,
tin, malleable,
diam. of tips 4 mm
400 mm



1/3

05-210 1,5 mm
05-211 2,0 mm
05-212 2,5 mm
300 mm

Ø tip

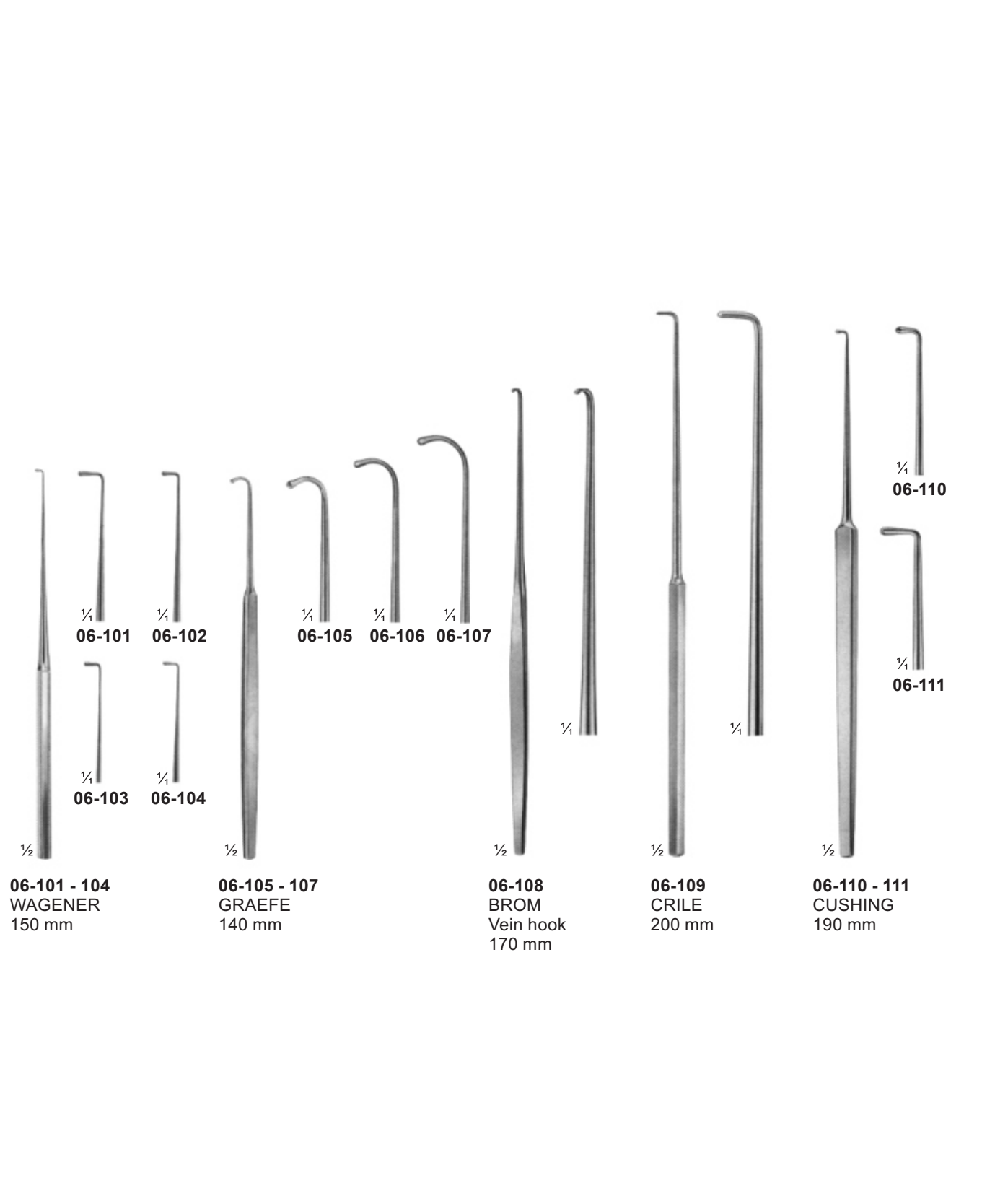

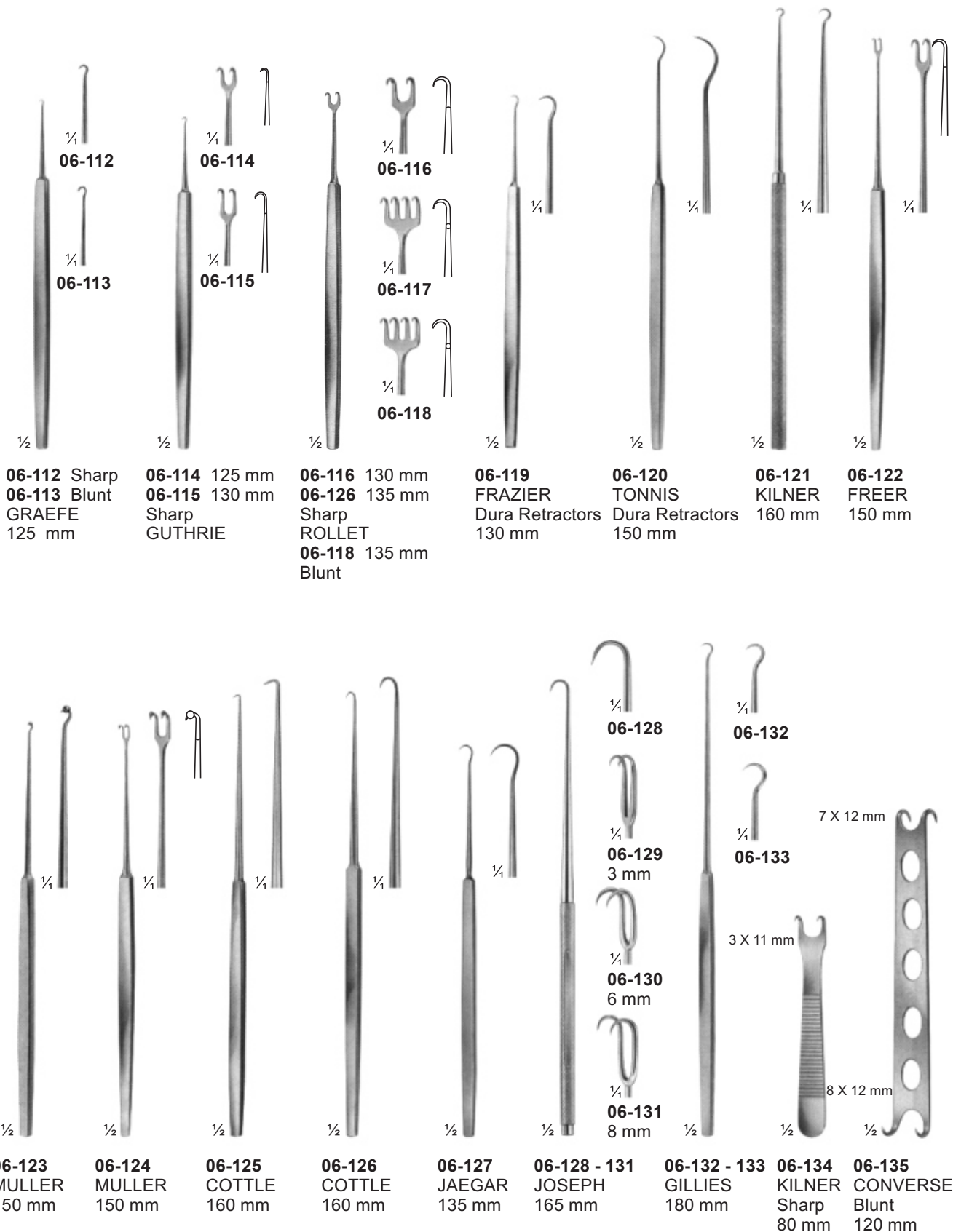

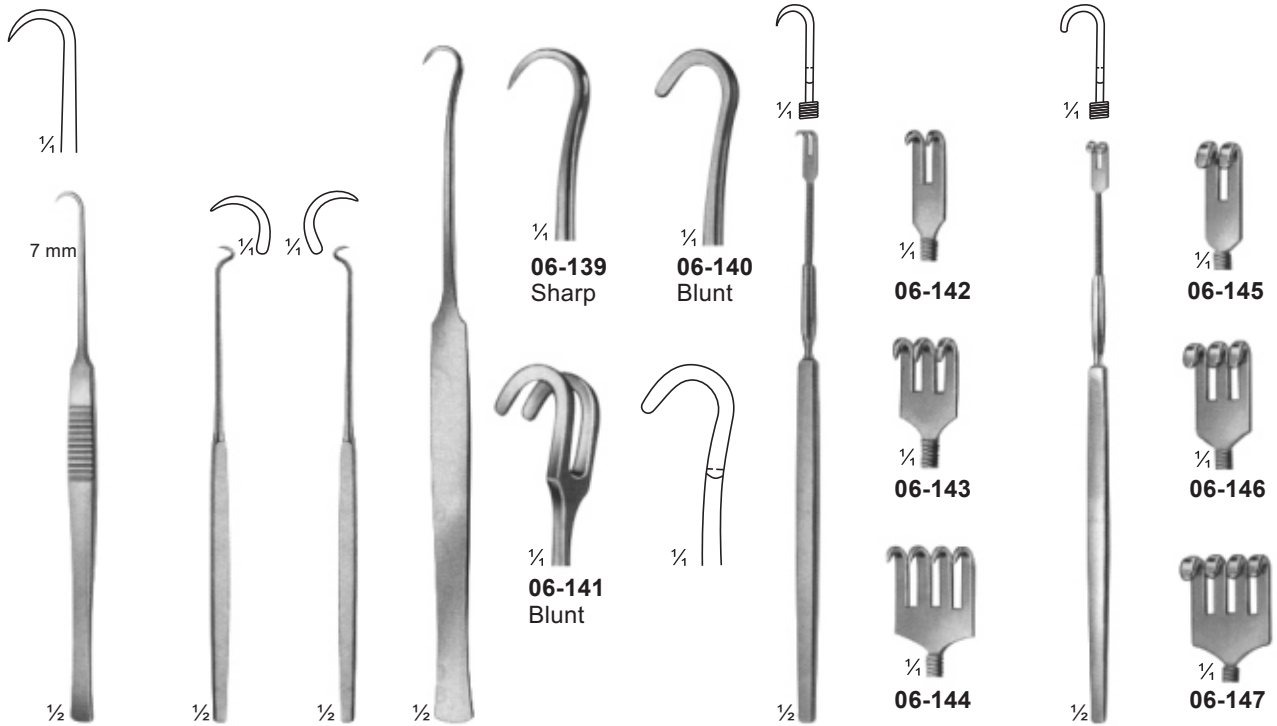

06-136 BERGMANN 140 mm
06-137 BOSE 165 mm
06-138 BOSE 165 mm
06-139 - 141 180 mm

06-142 - 144
 Flexible shaft, sharp
 155 mm

06-145 - 147
 Flexible shaft, blunt
 155 mm

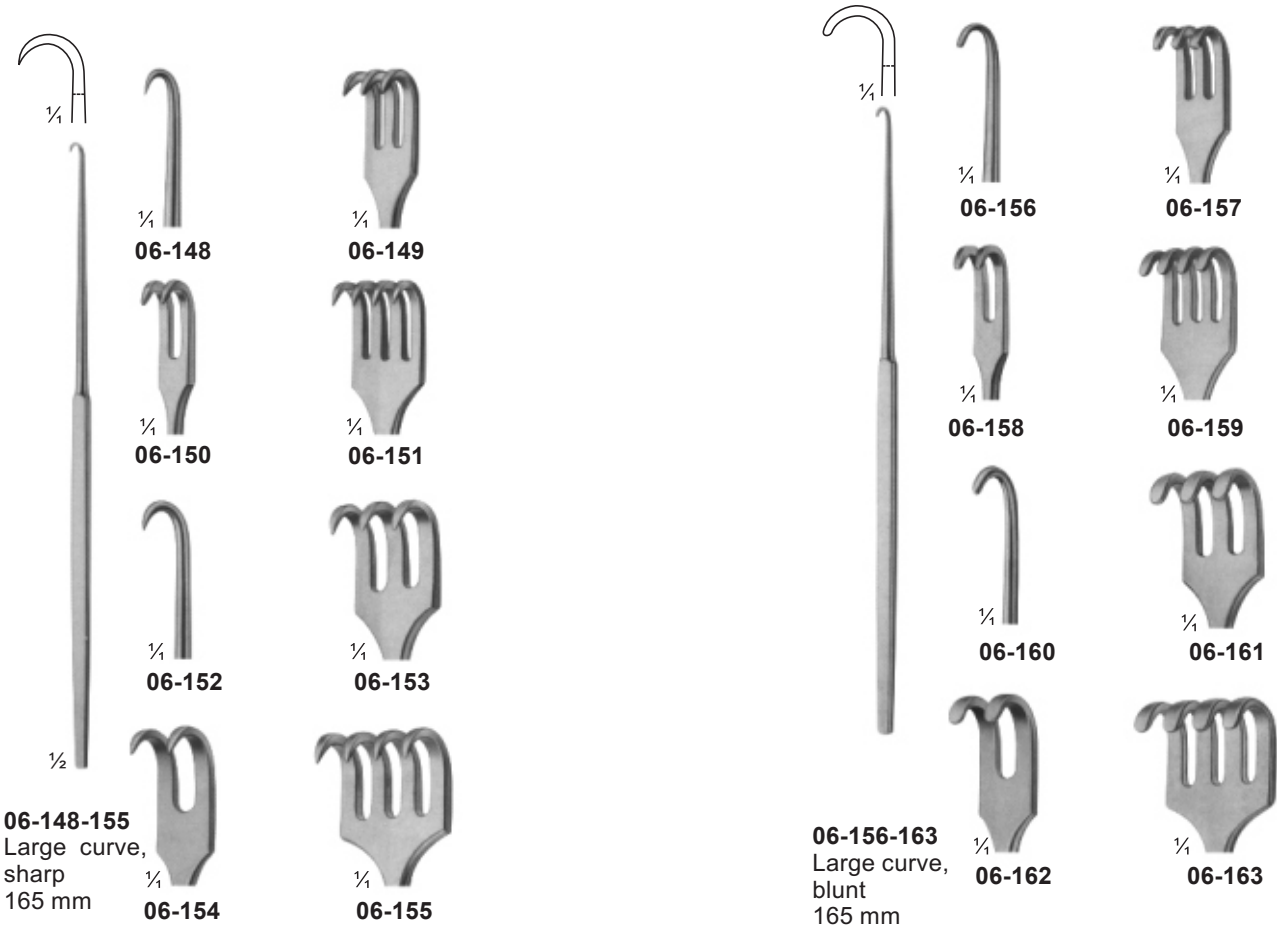

06-148-155
 Large curve,
 sharp
 165 mm

06-156-163
 Large curve,
 blunt
 165 mm



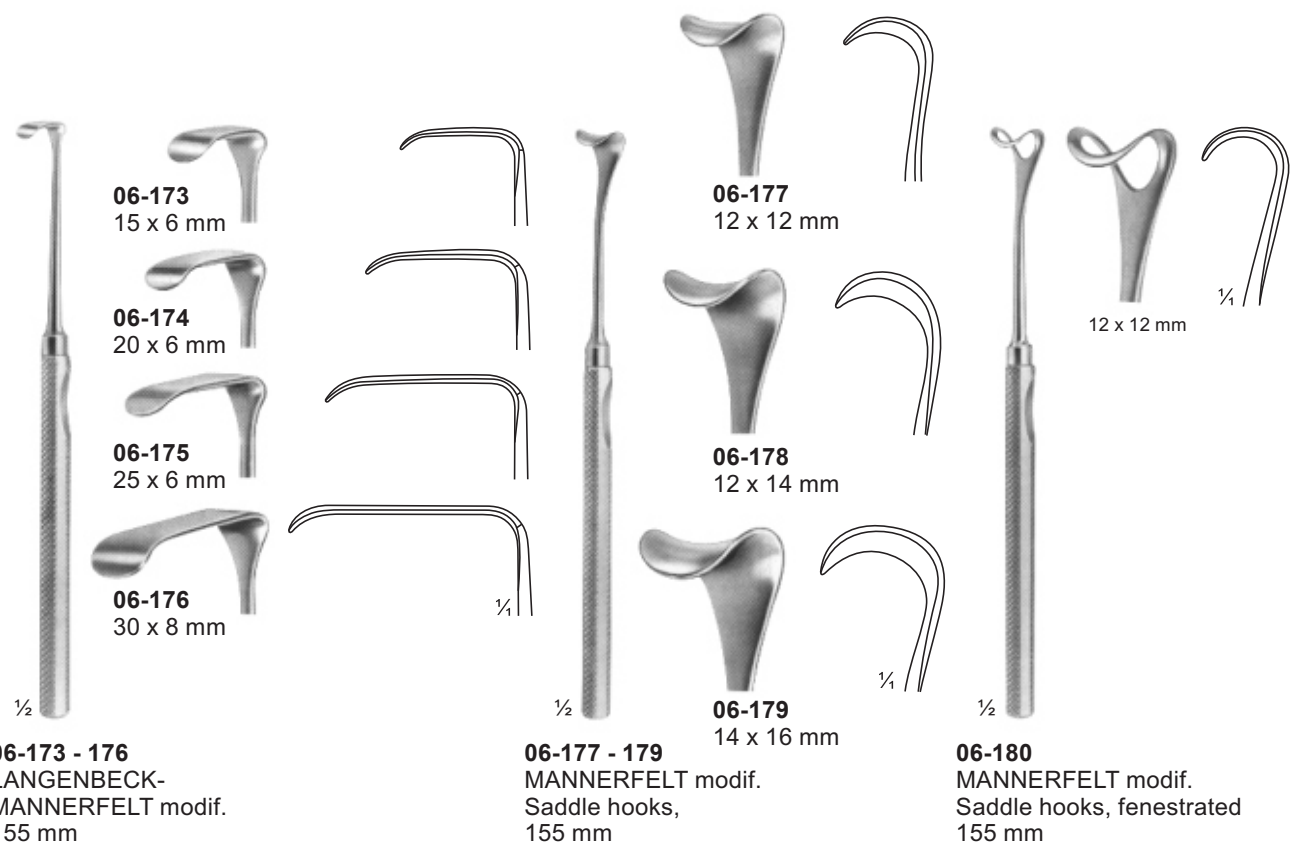
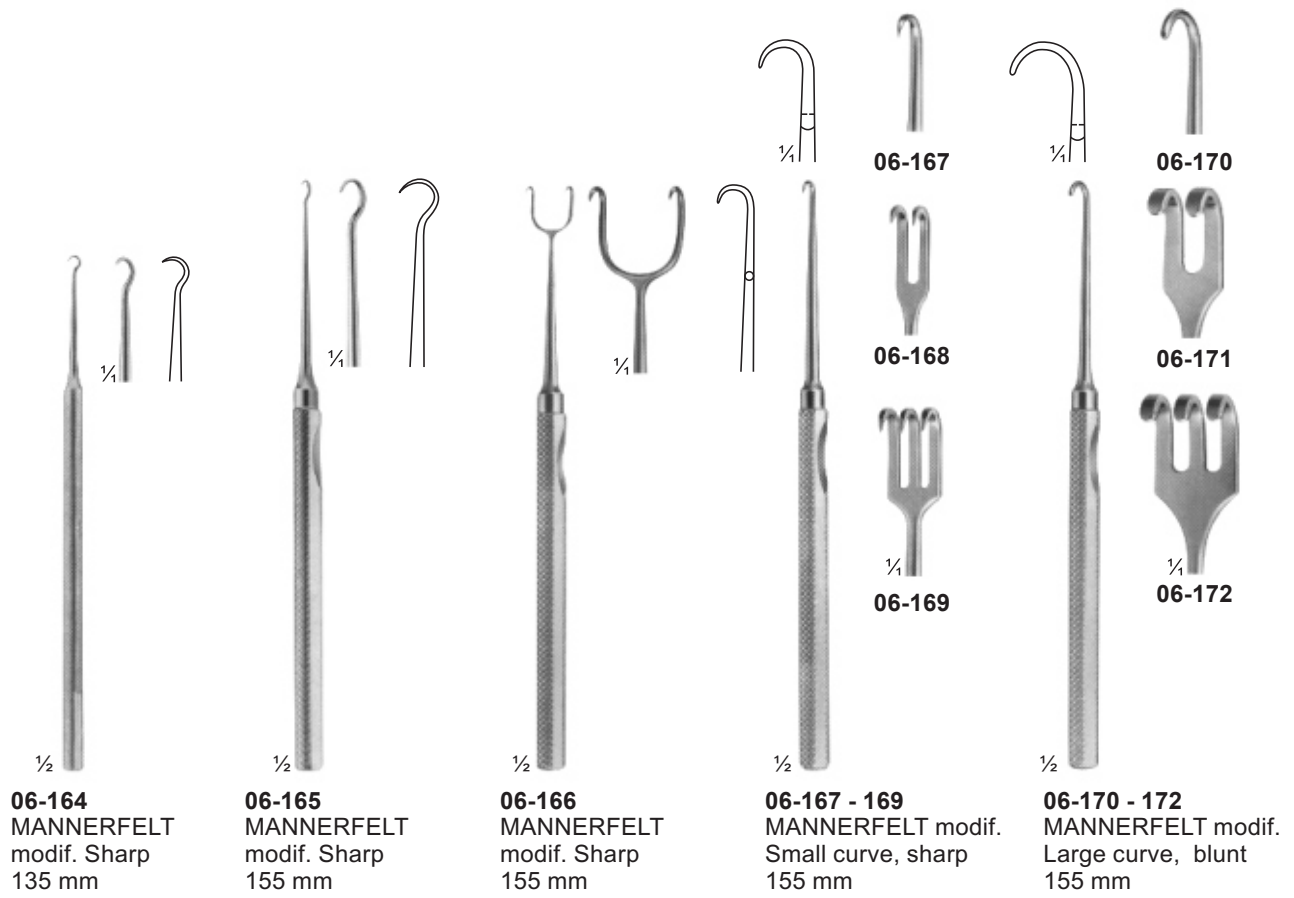

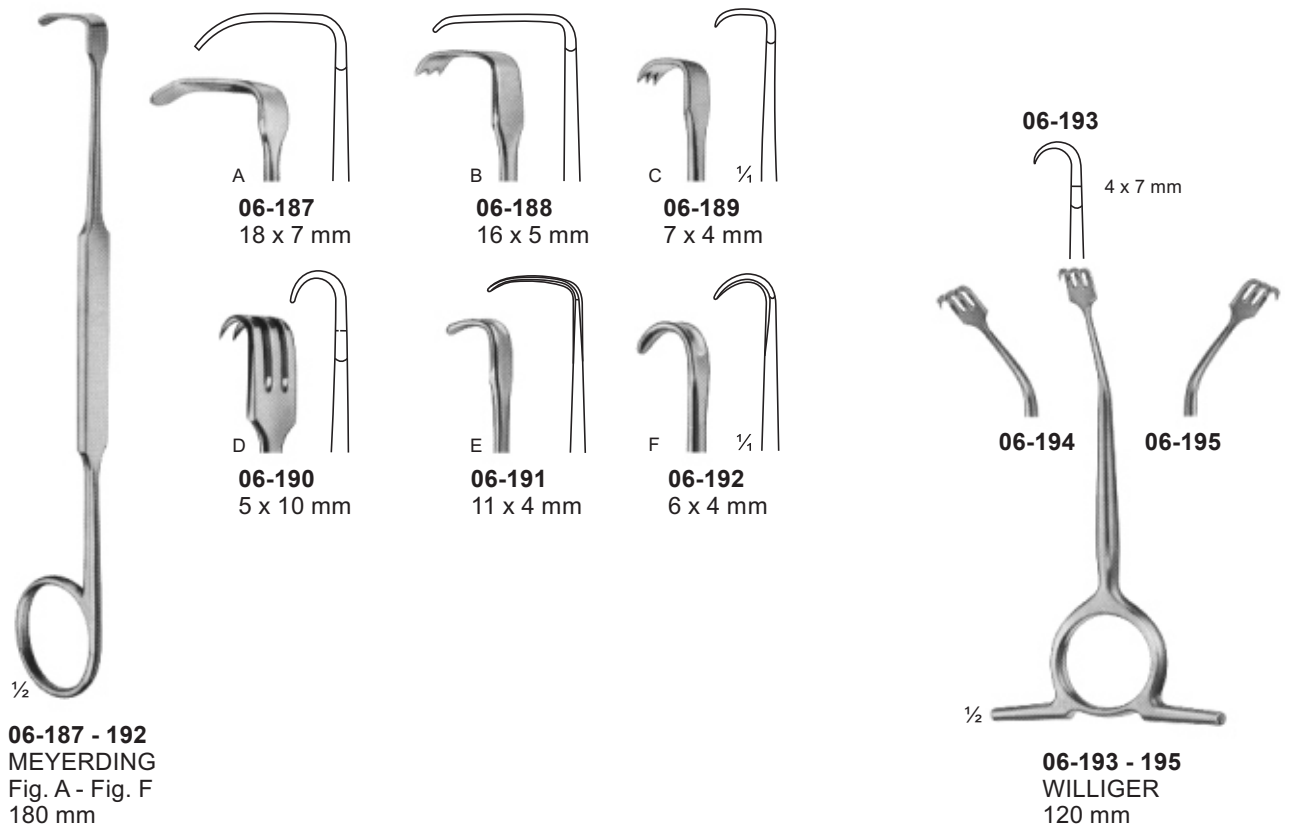
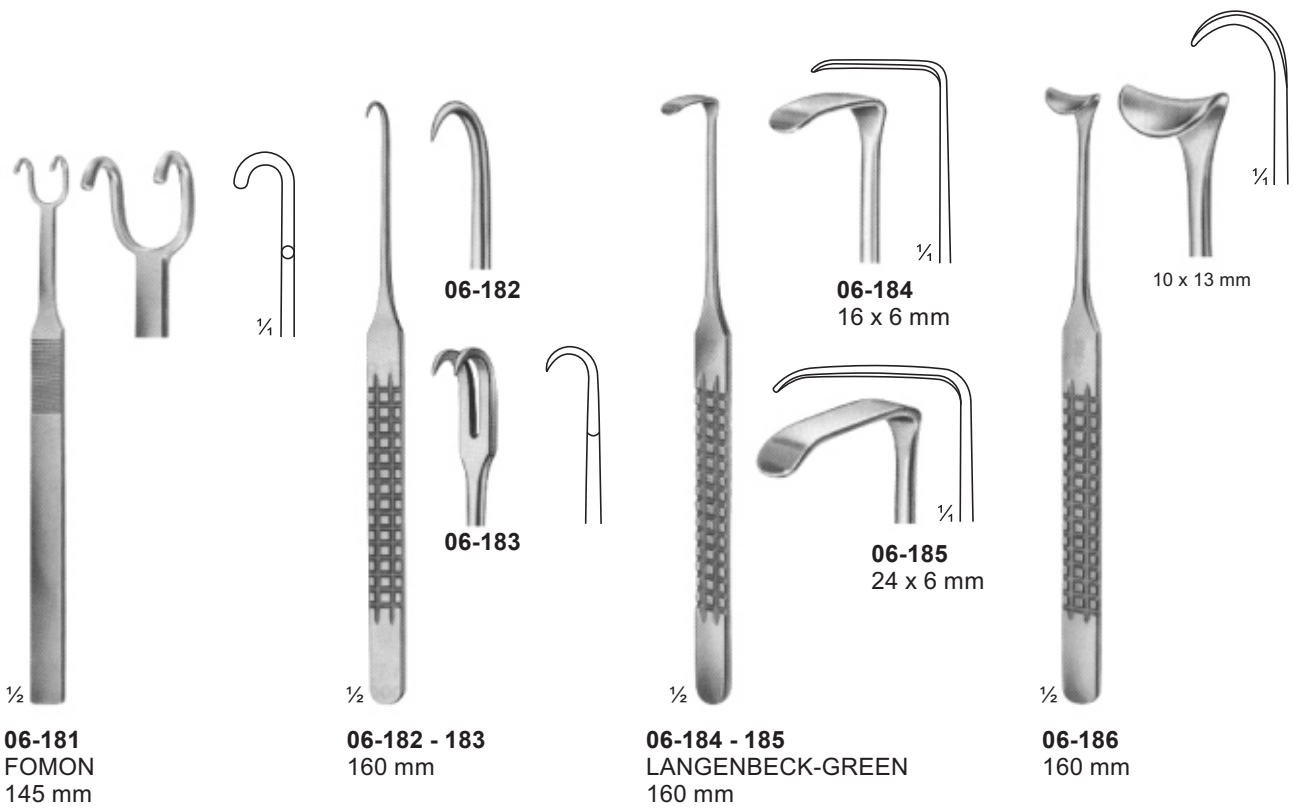



06-196
EMMETT
Fistula hook
220 mm

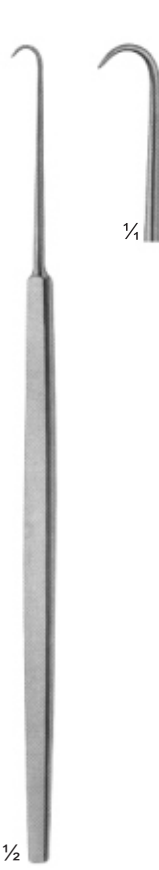

06-197
SIMON
Fistula hook
220 mm



06-198
SIMON
Fistula hook
220 mm



06-199
LANGE
Fistula hook
230 mm

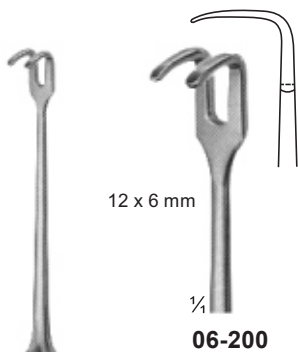

12 x 6 mm

06-200

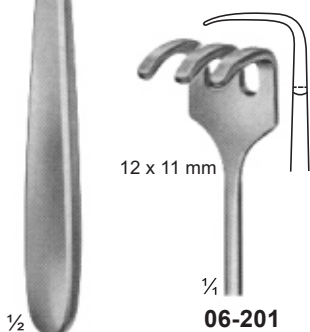

12 x 11 mm

06-201

06-200 - 201
Tendon hooks
175 mm

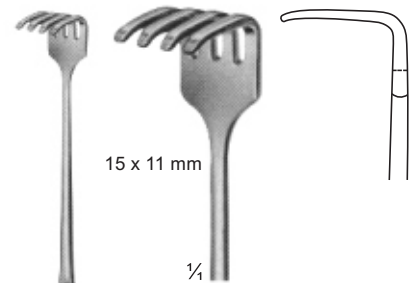

15 x 11 mm

06-202

06-202
KLAPP
Tendon hooks
175 mm

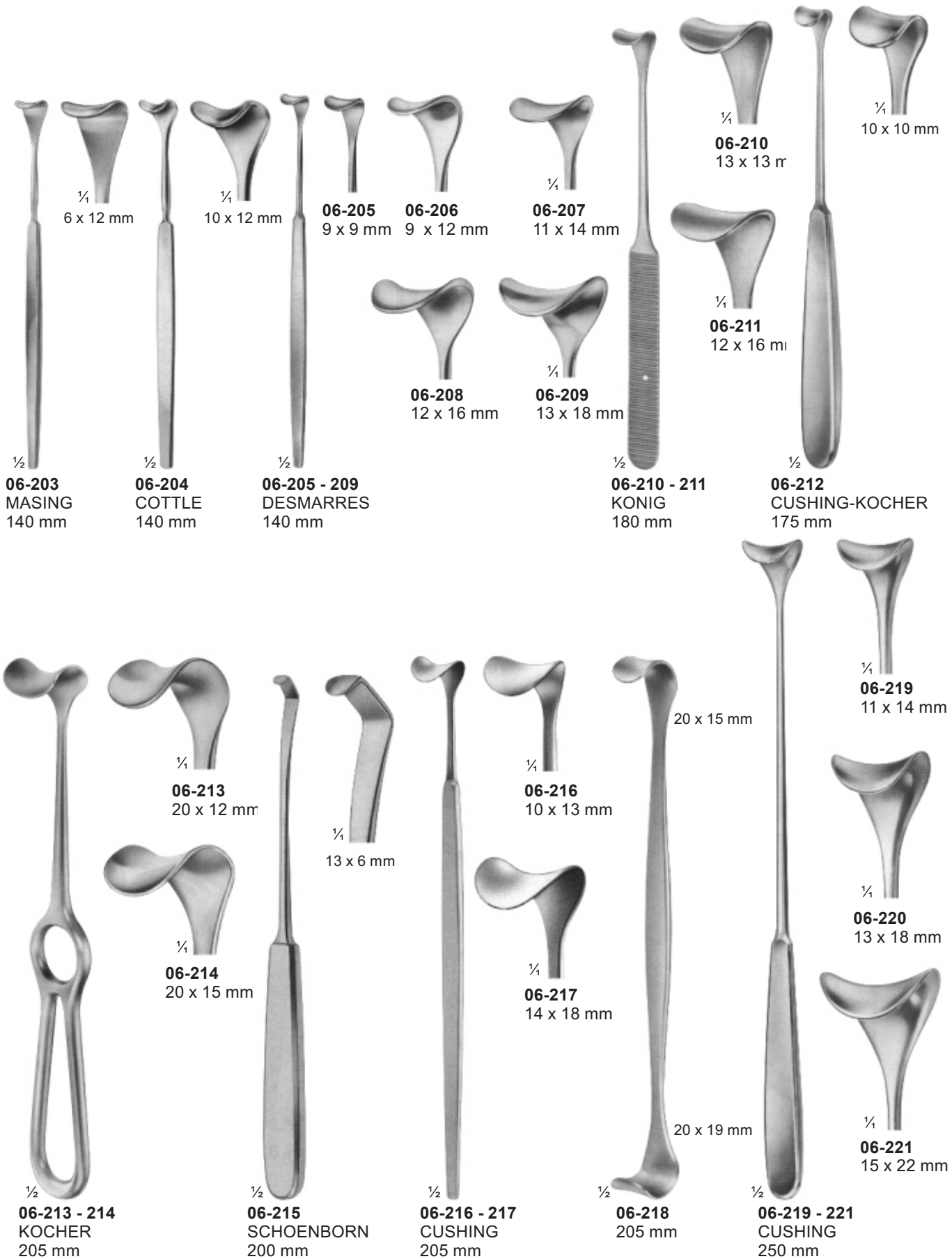

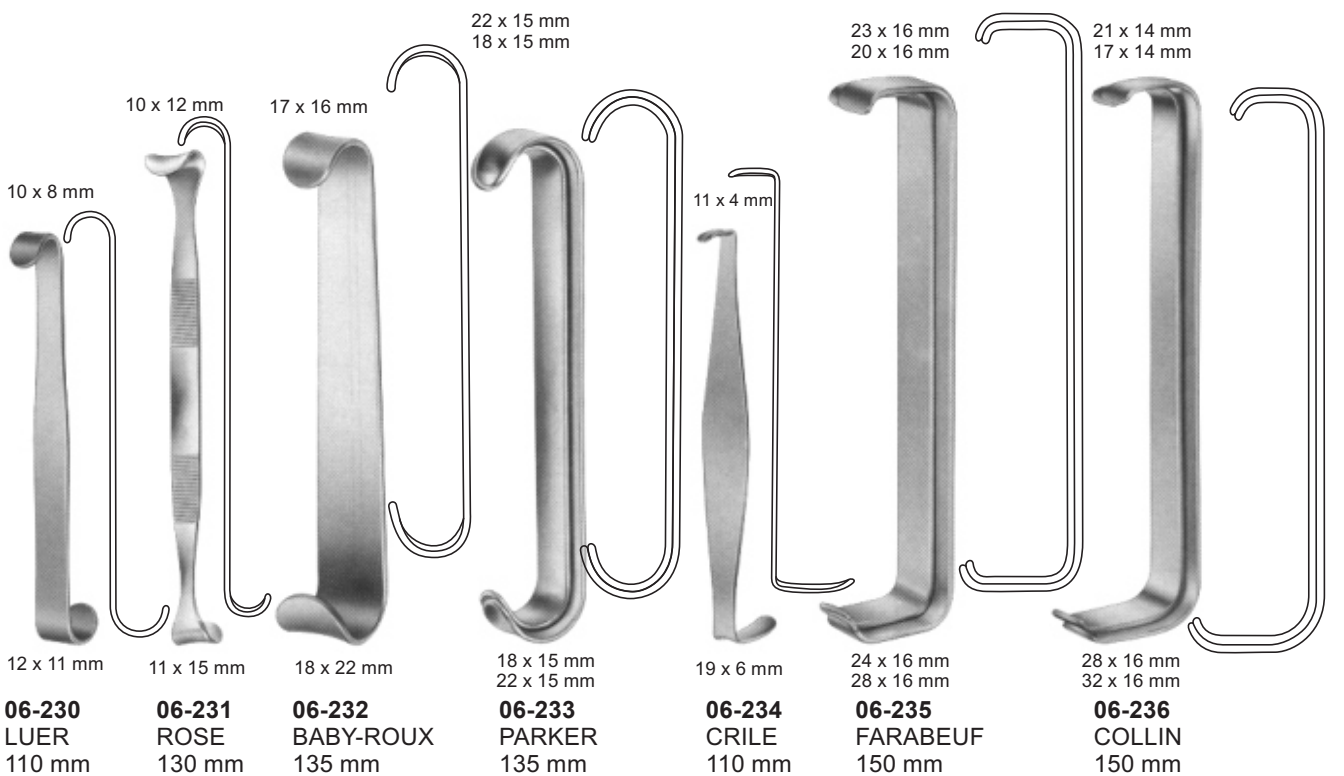
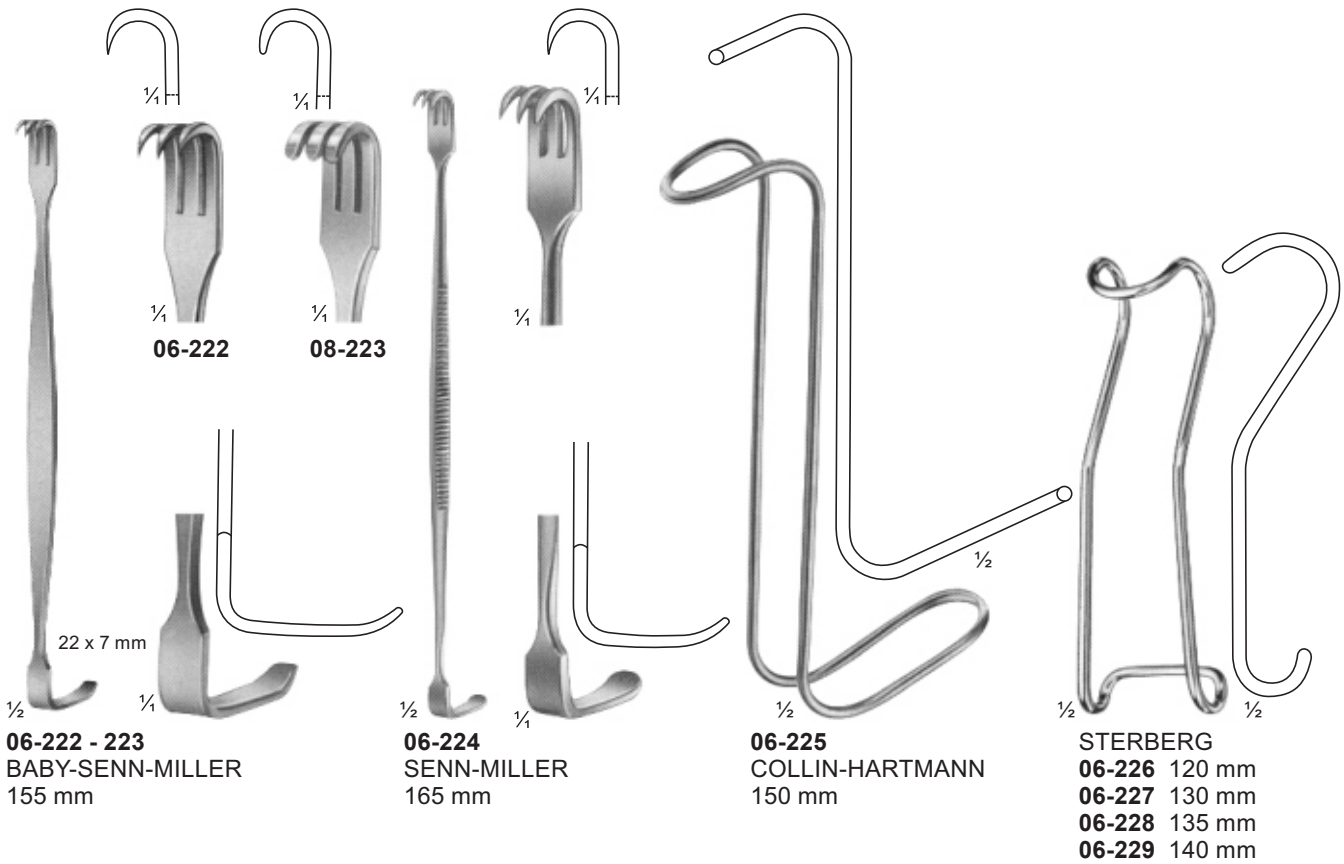

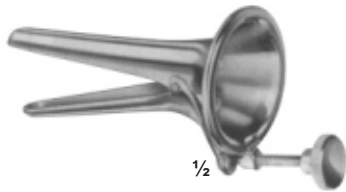

07-101
 COLLIN
 for children
 53 x 10 mm

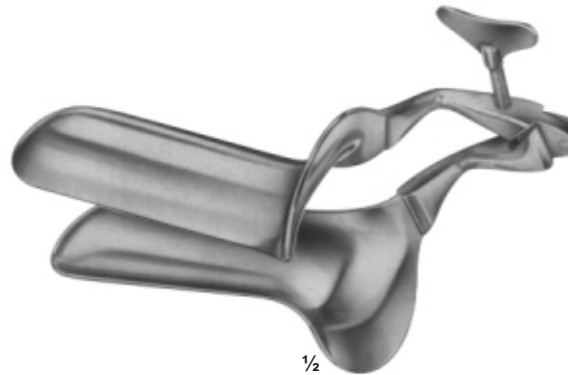

07-102 - 105
 COLLIN

07-102	100/90mm	28 mm
07-103	100/90mm	32 mm
07-104	105/95mm	35 mm
07-105	115/105mm	40 mm
	Total length/working length	width



07-106
 COLLIN
 for virgins
 95/85 x 18 mm



07-107
 CUSCO
 for virgins
 75 x 17 mm

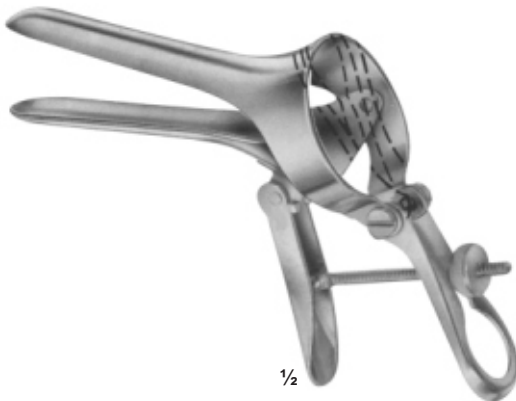

07-108
 CUSCO
 for virgins
 75 x 17 mm

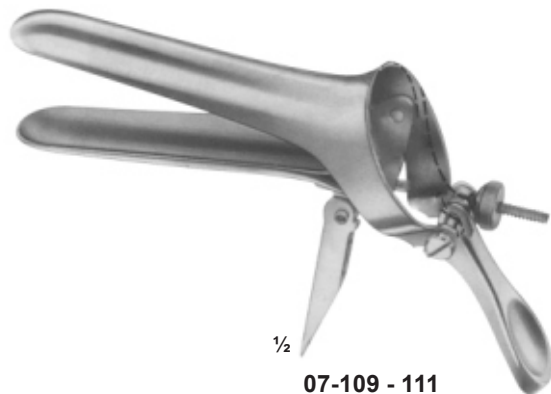

07-109 - 111
 CUSCO

07-109	92X23-25 mm
07-110	100x25-27 mm
07-111	110x27-30 mm





07-112 - 115
CUSCO
STANDARD
07-112 80X24 mm
07-113 80X32 mm
07-114 90X36 mm
07-115 110X37 mm



07-116 - 119
CUSCO
07-116 80X24 mm
07-117 80X32 mm
07-118 90X36 mm
07-119 110X37 mm



07-120 - 122
CUSCO
07-120 80X24 mm
07-121 80X32 mm
07-122 115X36 mm



07-123 - 124
SEYFFERT
07-123 100X24 mm
07-124 110X32 mm
230 mm



07-125
SEMM
for children
and virgins
180 mm

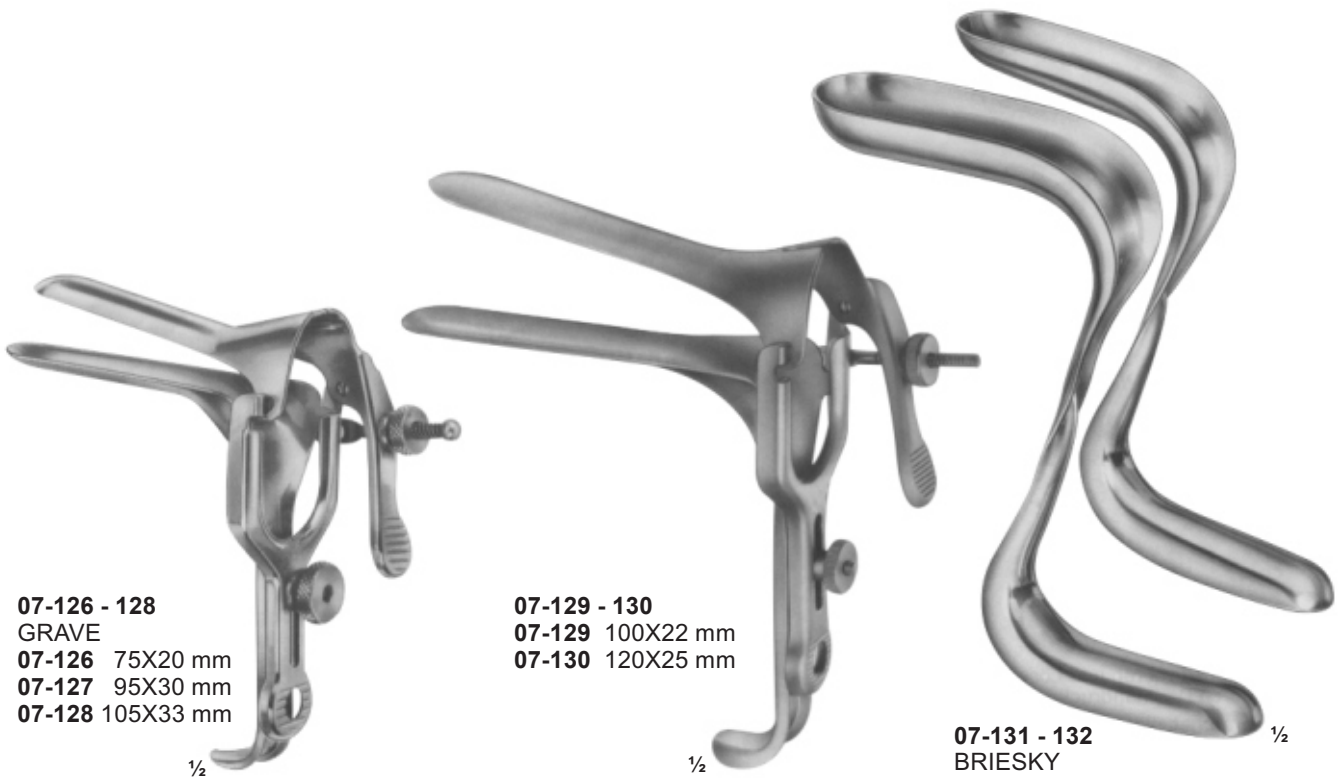

07-126 - 128
 GRAVE
07-126 75X20 mm
07-127 95X30 mm
07-128 105X33 mm

1/2

07-129 - 130
07-129 100X22 mm
07-130 120X25 mm

1/2

07-131 - 132
 BRIESKY
07-131 72X25 mm / 77X30 mm
07-132 75X30 mm / 92X38 mm
 170 mm

1/2

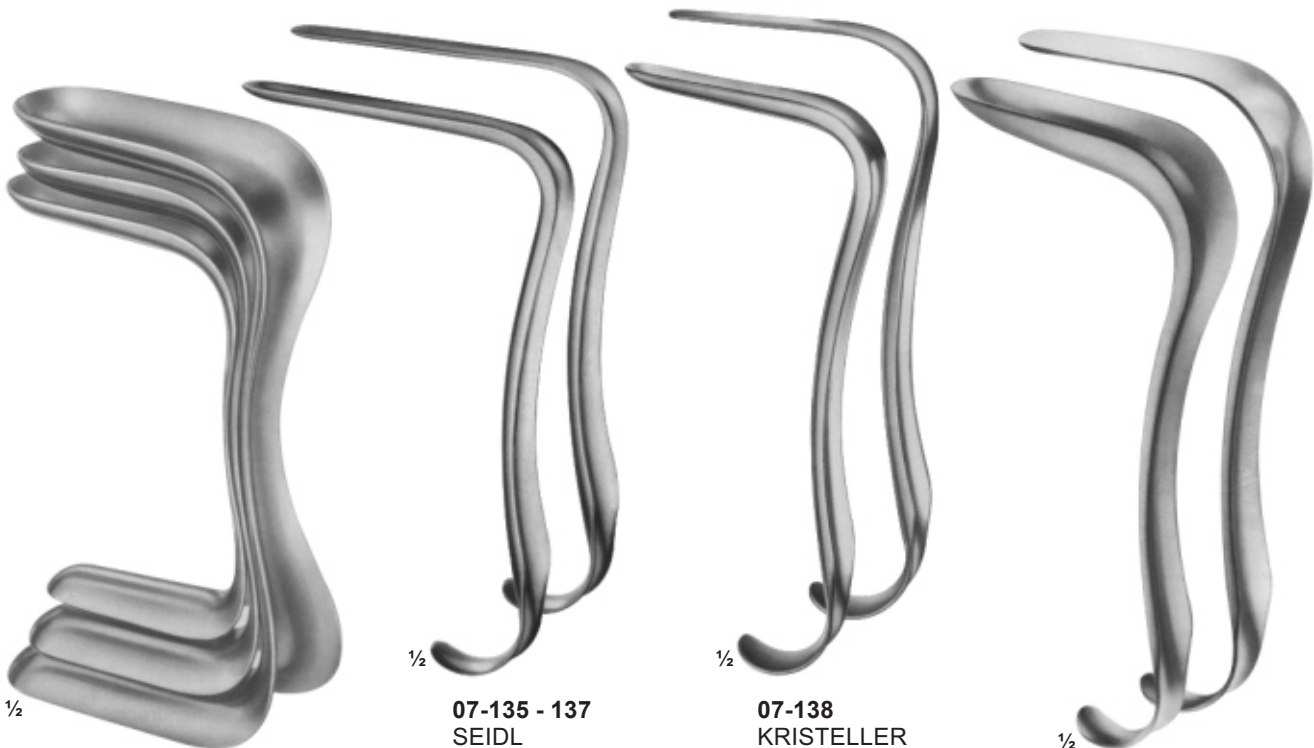

1/2

07-133 - 134
 BREISKY
07-133 100X22 mm
 77 X30 mm
 140 mm
07-134 120X25 mm
 92 X38 mm
 170 mm

1/2

07-135 - 137
 SEIDL
07-135 80X8 mm
07-136 80X10 mm
07-137 90X14 mm
 For children and infants
 170 mm

1/2

07-138
 KRISTELLER
 70X15 mm, (170 mm)
 For children

1/2

07-139 - 141
 SIMS
07-139 70X26 mm
 75 X30 mm 125 mm
07-140 75X30 mm
 80 X85 mm 150 mm
07-141 80X36 mm
 90 X40 mm 175 mm





07-142 - 146
KRISTELLER
07-142 110X18 mm
07-143 110X20 mm
07-144 110X27 mm
07-145 110X30 mm
07-146 110X36 mm
 220 mm

07-147 - 150
KRISTELLER
 Upper blades

07-151 - 154
KRISTELLER
 Lower blades

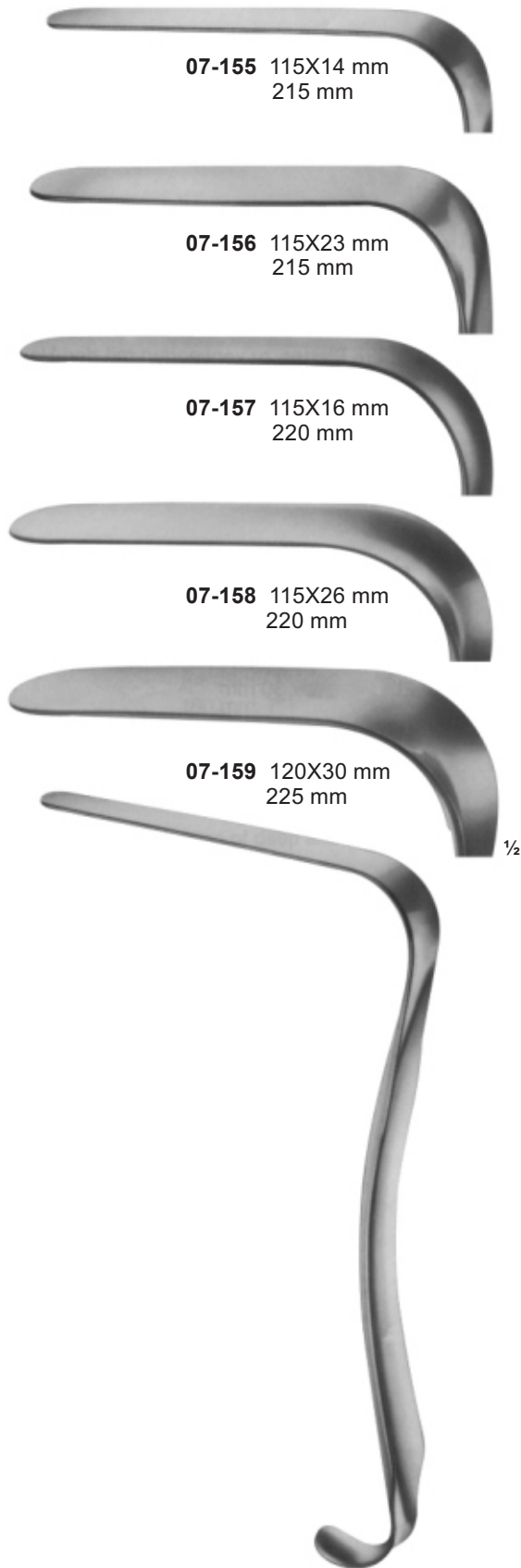

07-155 115X14 mm
215 mm

07-156 115X23 mm
215 mm

07-157 115X16 mm
220 mm

07-158 115X26 mm
220 mm

07-159 120X30 mm
225 mm

07-155 - 159
KRISTELLER
Upper blades

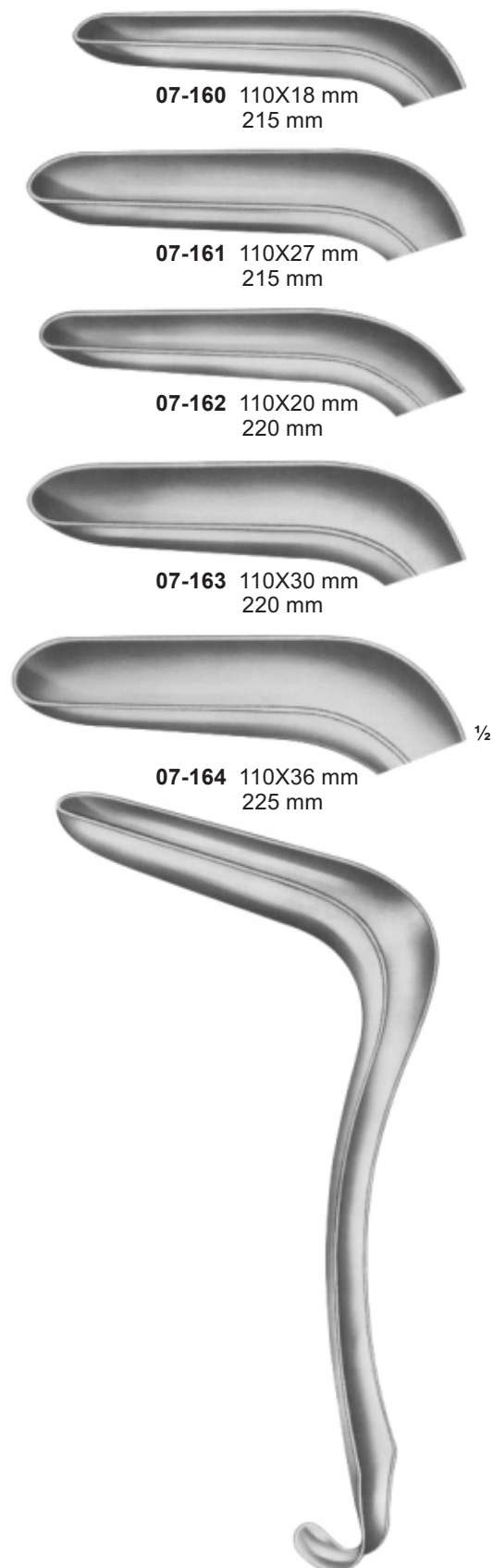

07-160 110X18 mm
215 mm

07-161 110X27 mm
215 mm

07-162 110X20 mm
220 mm

07-163 110X30 mm
220 mm

07-164 110X36 mm
225 mm

07-160 - 164
KRISTELLER
Lower blades



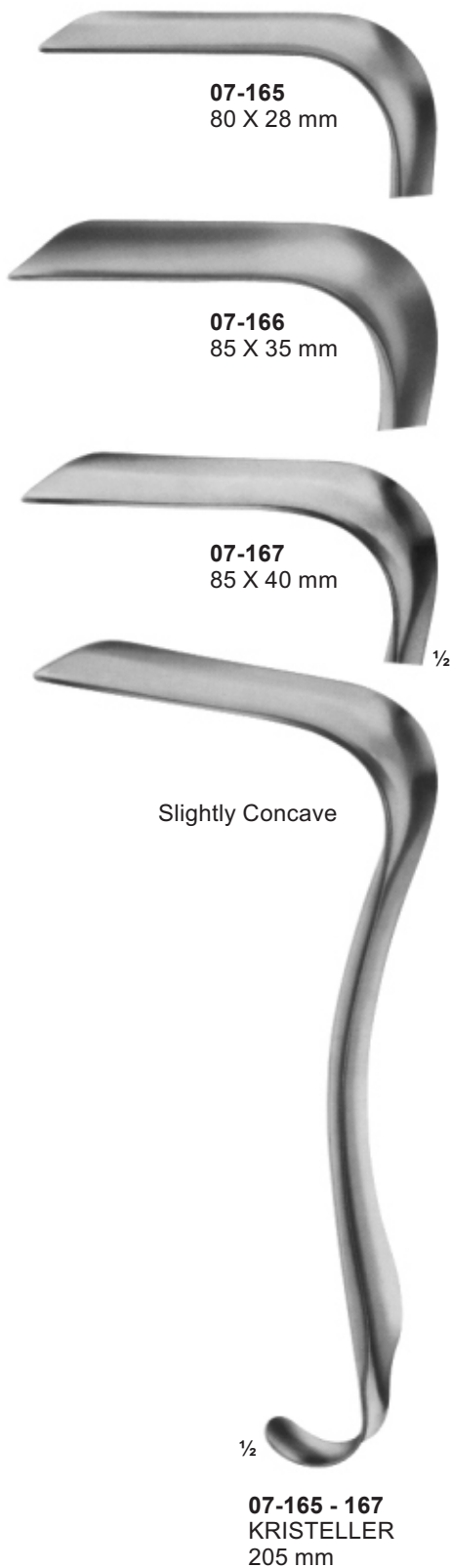





07-176 - 178
DOYEN
235 mm

Length of blades	Width of blades		60 mm ^{1/2}
	35 mm	45 mm	
60 mm	35 mm	45 mm	60 mm ^{1/2}
90 mm	07-179	07-182	07-186
120 mm	07-180	07-183	07-187
160 mm	07-181	07-184	07-188
		07-185	07-189



½

07-190 - 194
 BREISKY
 WIENER MODELL/
 VIENNA PATTERN
07-190 100 X 20 mm
07-191 100 X 25 mm
07-192 100 X 30 mm
07-193 100 X 35 mm
07-194 100 X 40 mm
 300 mm



½

07-195 - 199
 BREISKY
 WIENER MODELL/
 VIENNA PATTERN
07-195 130 X 20 mm
07-196 130 X 25 mm
07-197 130 X 30 mm
07-198 130 X 35 mm
07-199 130 X 40 mm
 320 mm



½

07-200
 DOYEN
 lateral speculum
 80 x 30 mm
 250 mm



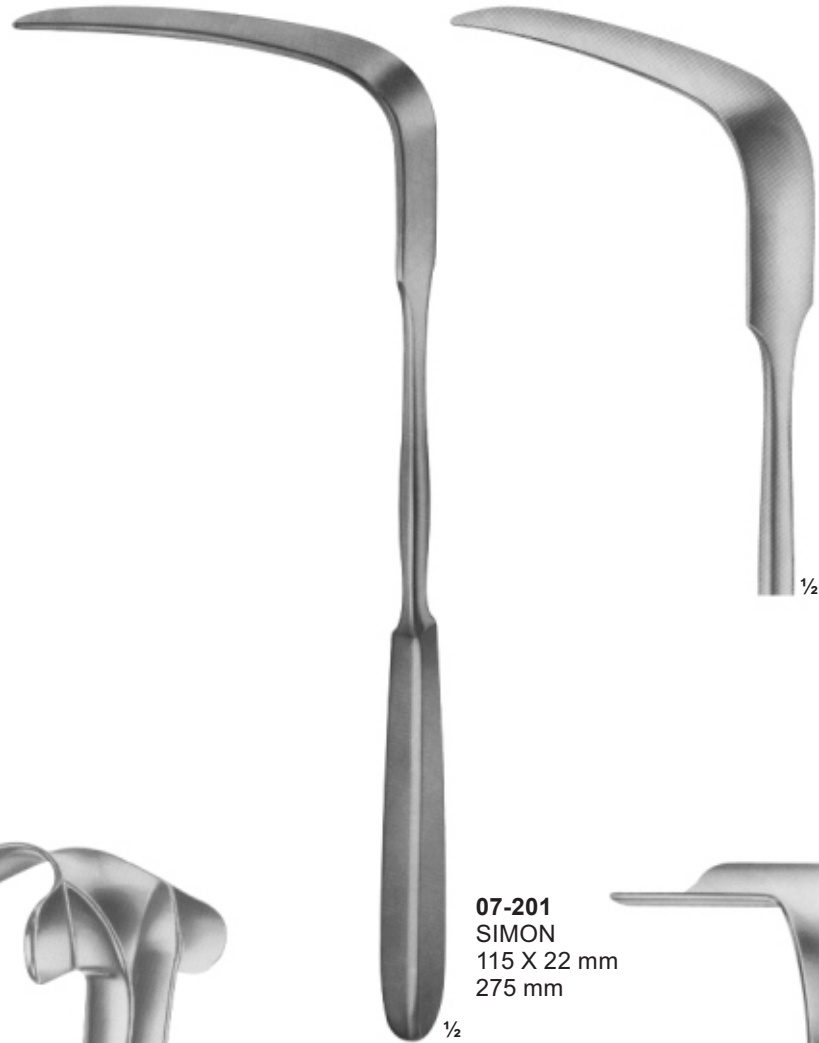

07-201
SIMON
115 X 22 mm
275 mm



07-202
AUVARD
65 X 38 mm - 28 mm
1,530 kg
with fixed weight
230 mm



07-203 - 204
AUVARD
12-203 75 X 42 mm
(40 mm)
07-204 105 X 43 mm
(40 mm)
with detachable wight
230 mm

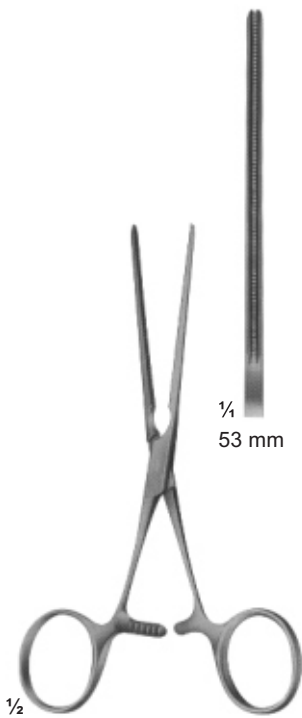

08-101
 DE-BAKEY
 gerade straight
 130 mm

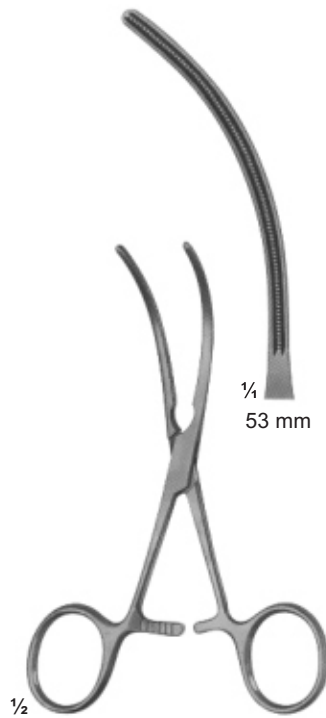

08-102
 DE-BAKEY
 Maul gebogen
 curved jaws
 125 mm

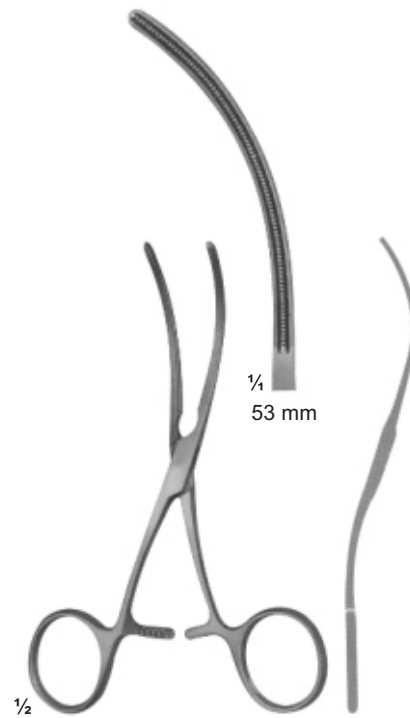

08-103
 DE-BAKEY
 S-shaped curved
 125 mm

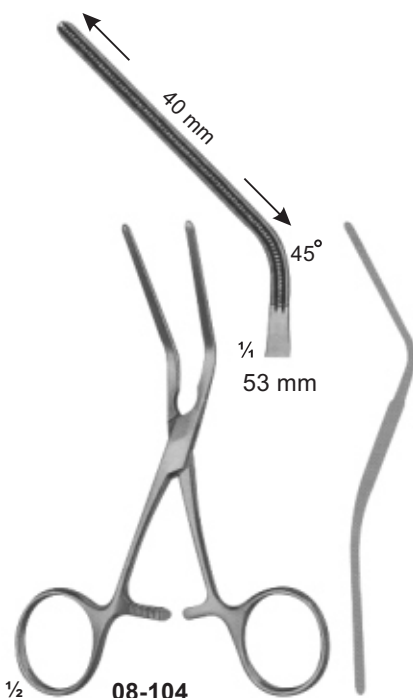

08-104
 DE-BAKEY
 45 winklig gebogen
 angled 45°
 125 mm

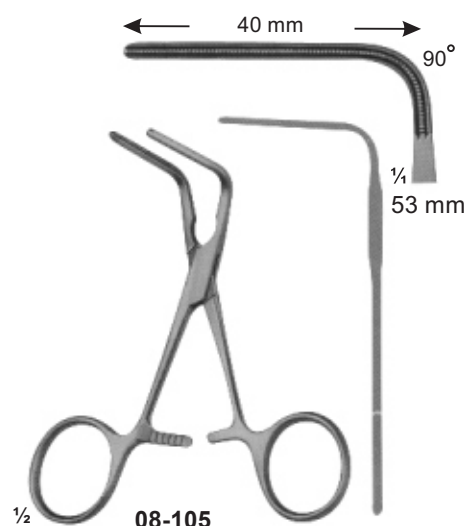

08-105
 DE-BAKEY
 90 winklig gebogen
 angled 90°
 105 mm

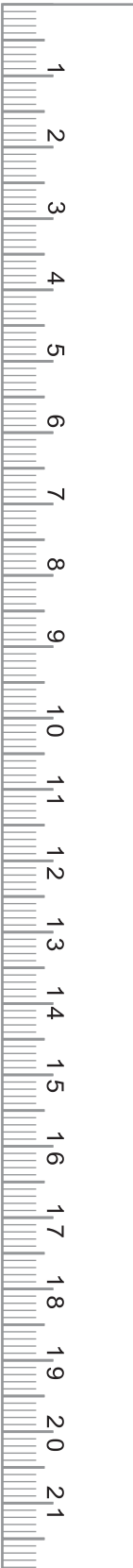

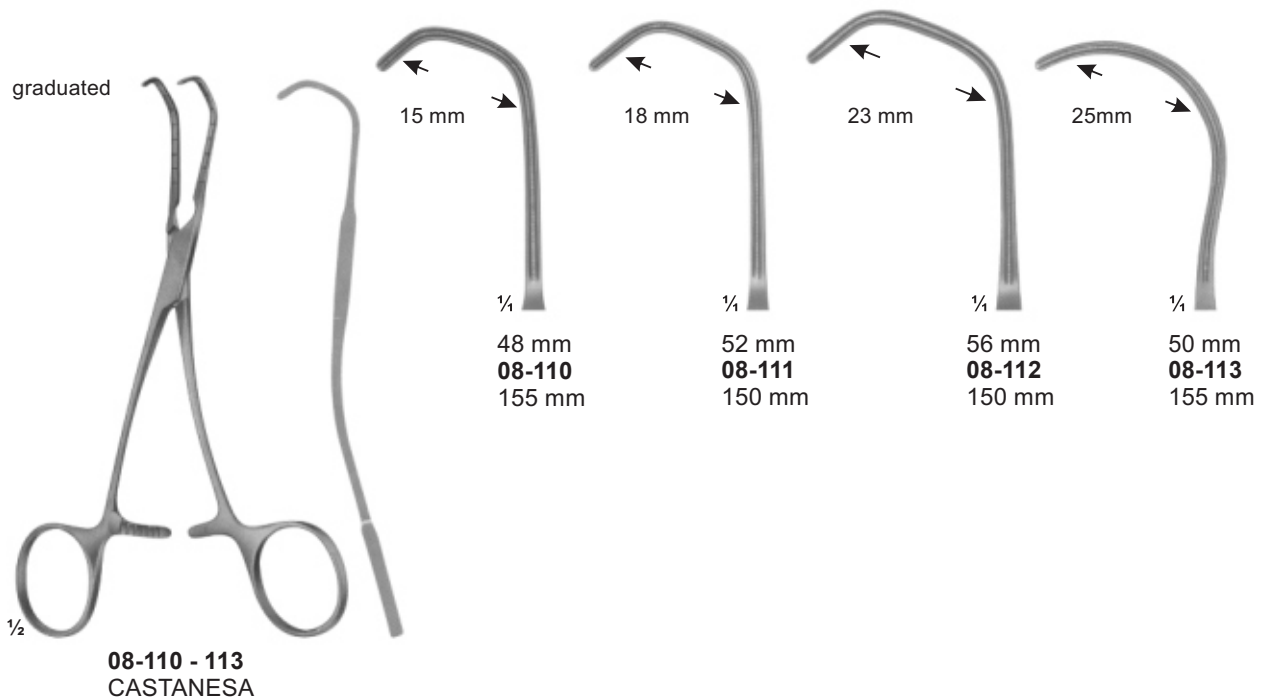
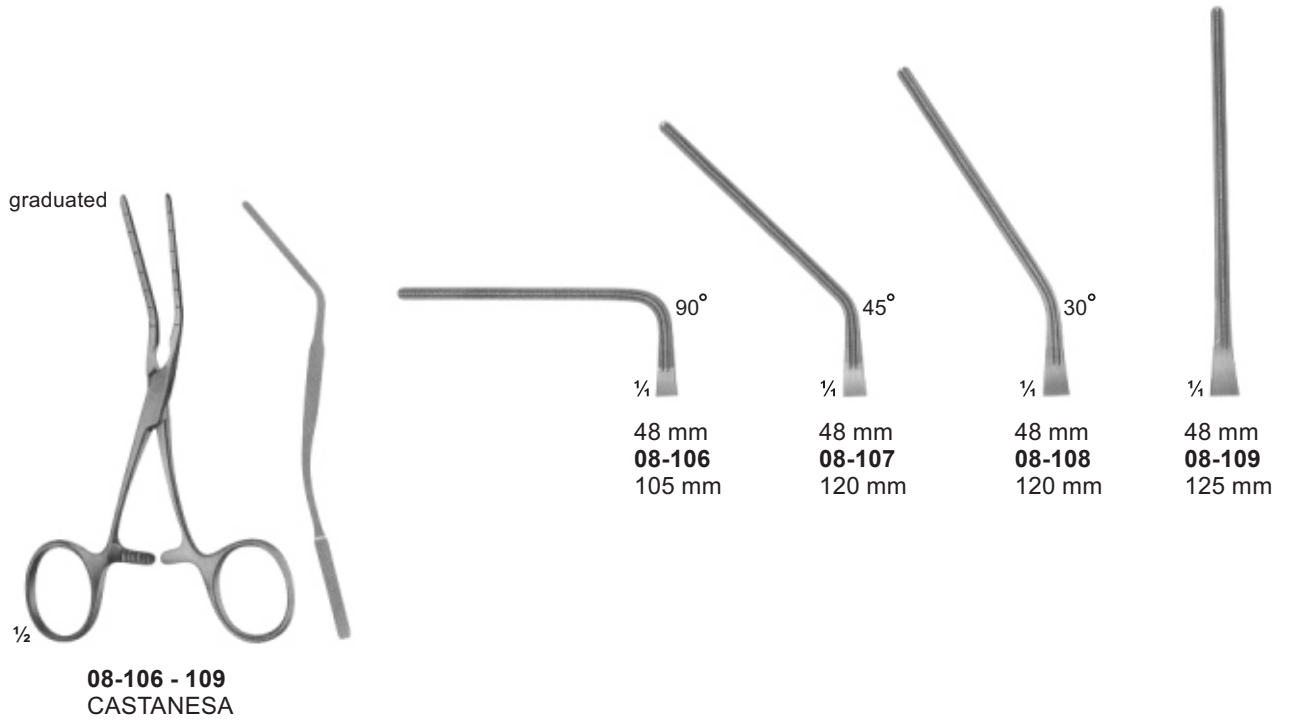

Anastomosis-and Multi-purpose-clamps-pediatric Types
Anastomose-und Multi-purpose-clamp-pediatric-typen
Anastomosis Y De Propósitos Múltiples De Abrazaderas-pediátricos Tipos

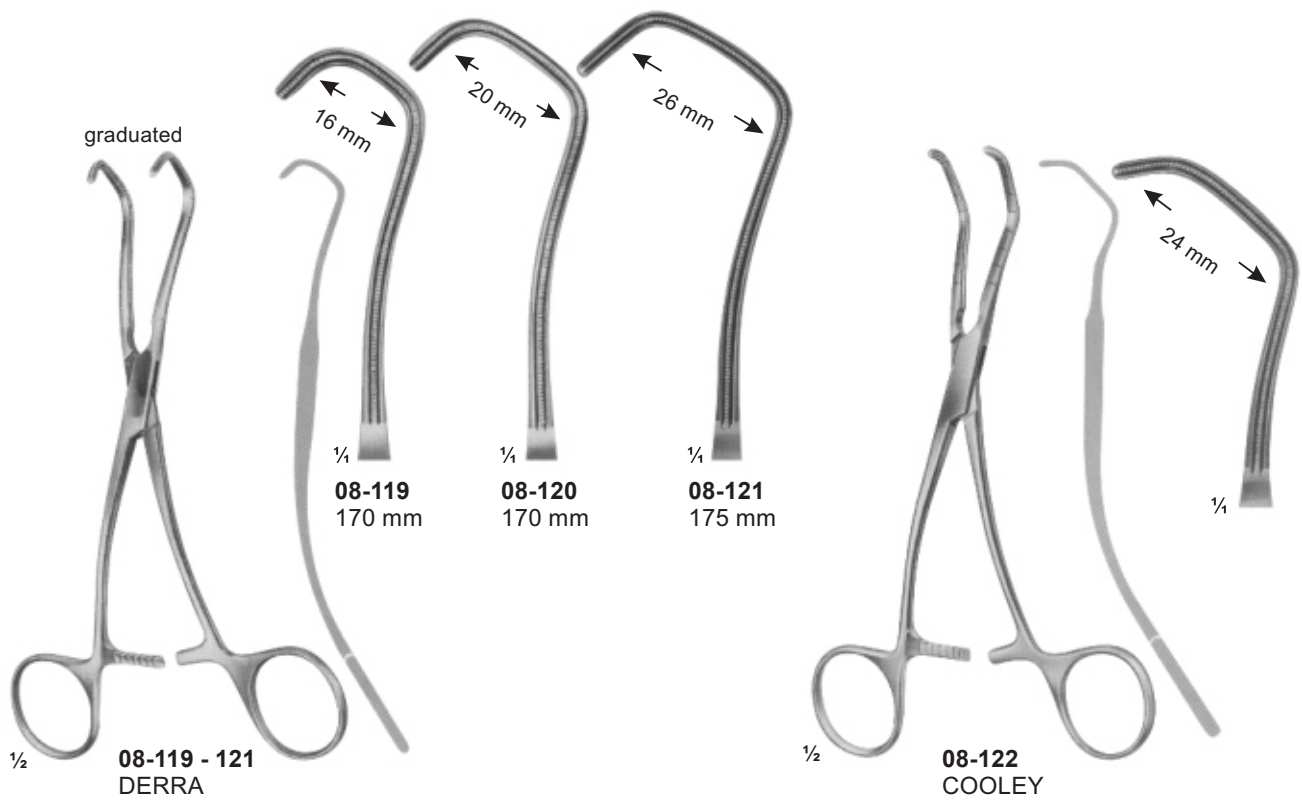
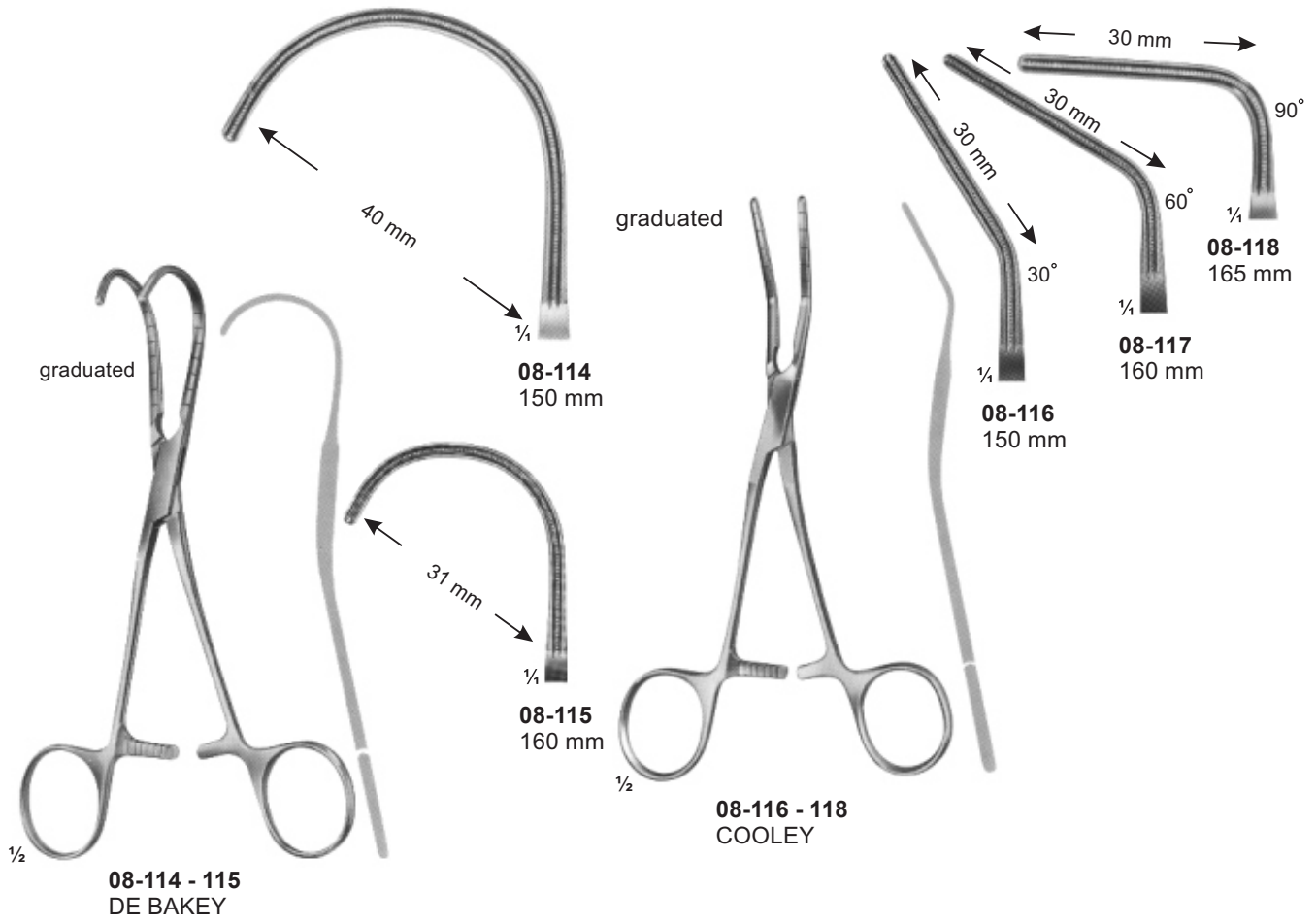

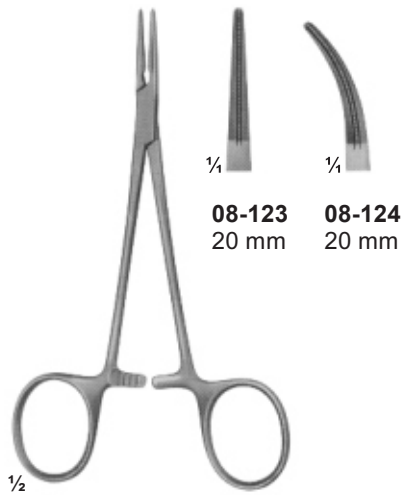

08-123
20 mm

08-124
20 mm

08-123 - 124
HALSTED
125 mm

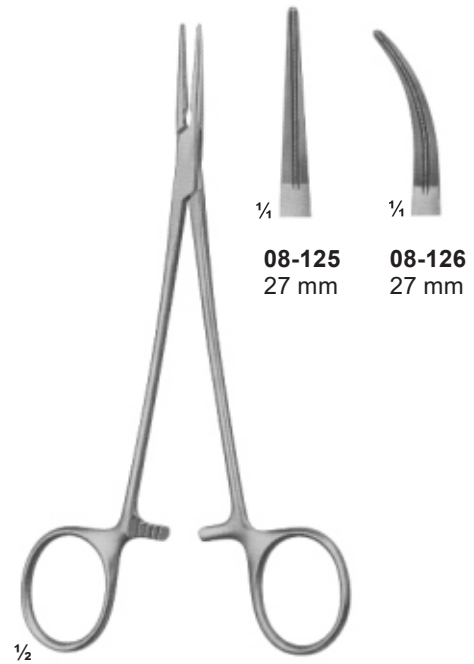

08-125
27 mm

08-126
27 mm

08-125 - 126
RANKIN
165 mm

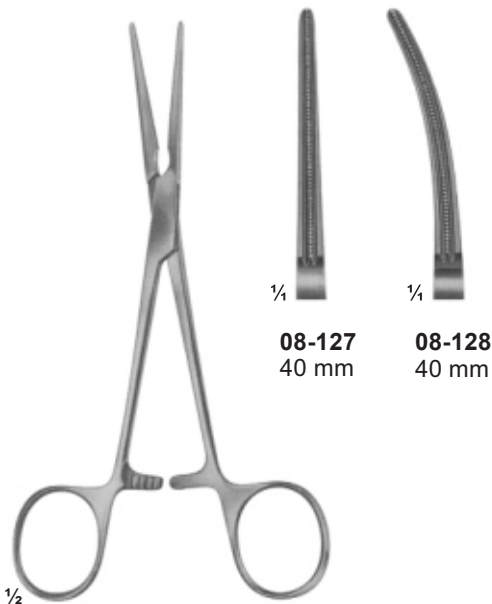

08-127
40 mm

08-128
40 mm

08-127 - 128
DE BAKEY-BAINRIDGE
155 mm

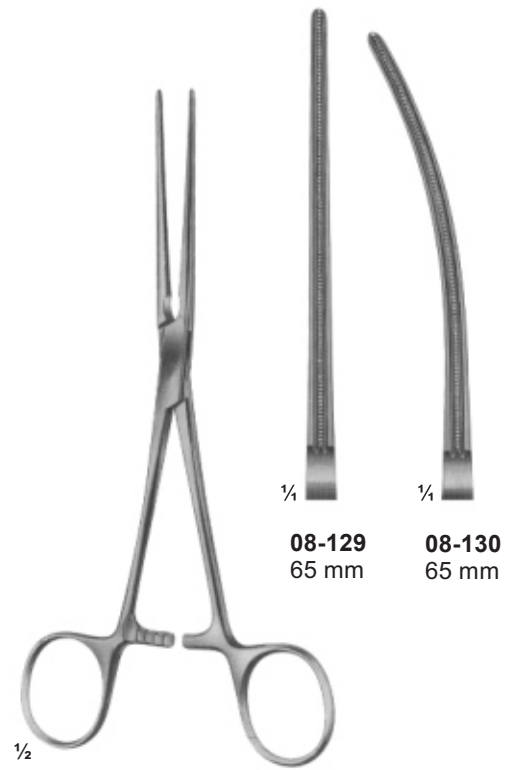

08-129
65 mm

08-130
65 mm

08-129 - 130
DE BAKEY-BAINRIDGE
180 mm

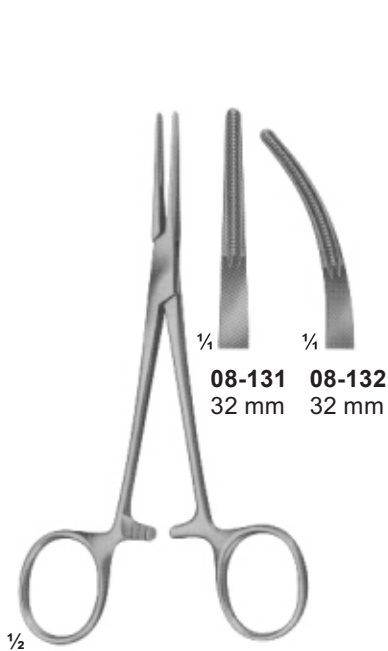

08-131 - 132
DE-BAKEY-KELLY
 140 mm

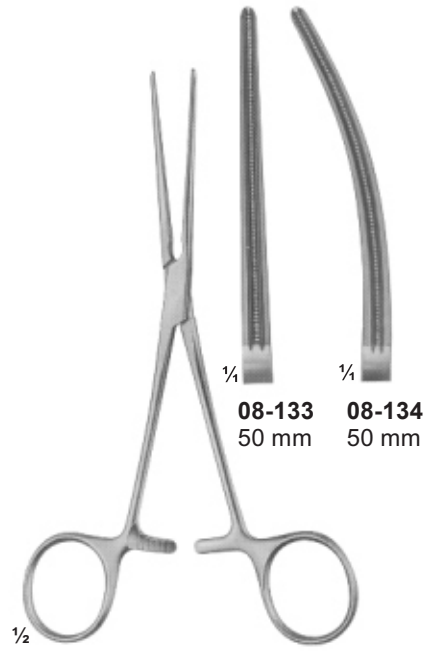

08-133 - 134
PEAN
 155 mm

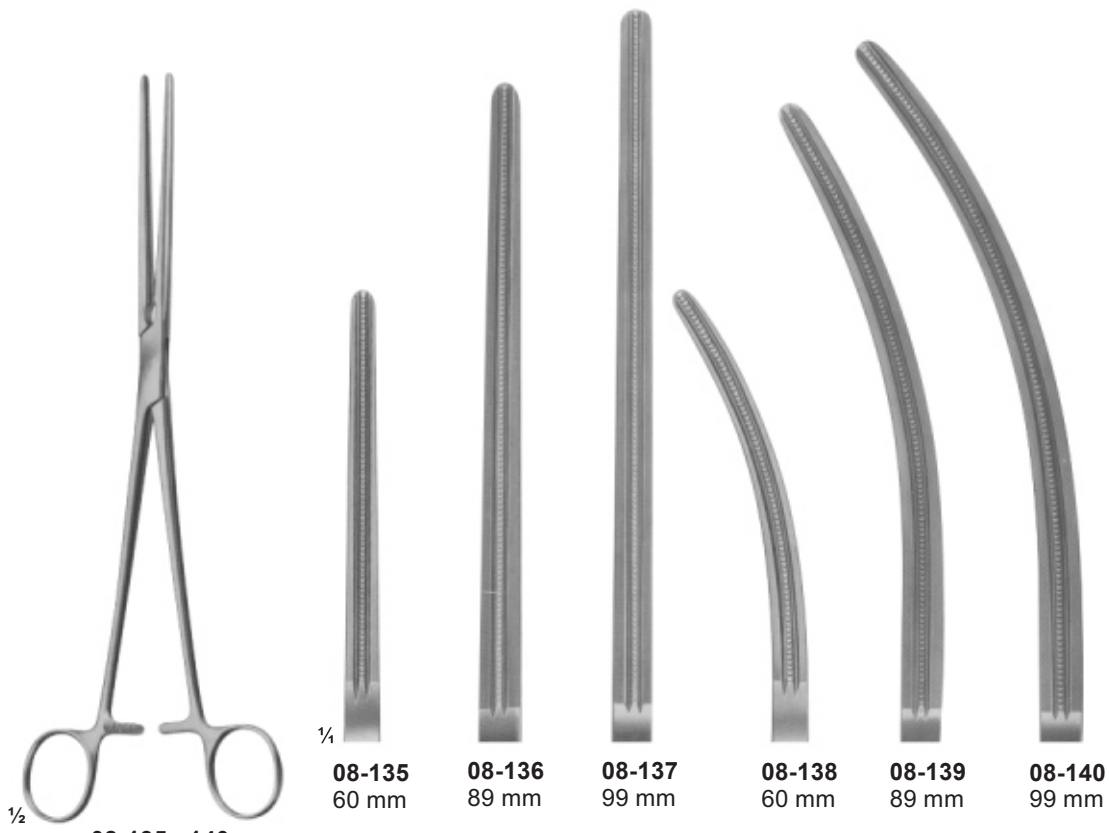

08-135 - 140
DE-BAKEY-PEAN DE-BAKEY-PEAN
08-135 200 mm **08-138** 200 mm
08-136 265 mm **08-139** 260 mm
08-137 280 mm **08-140** 275 mm

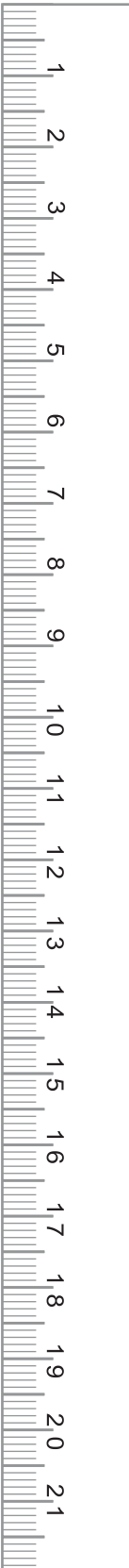

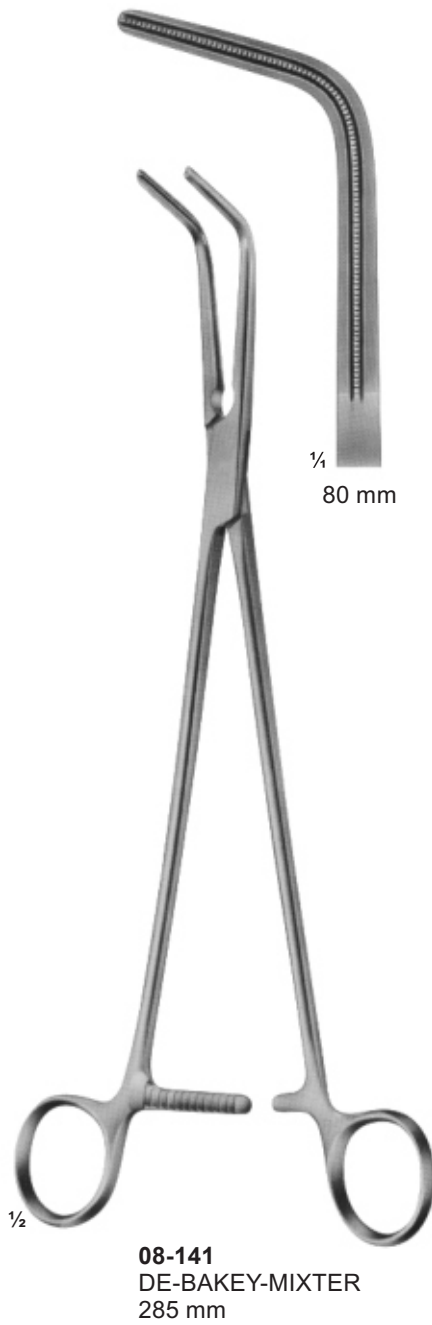

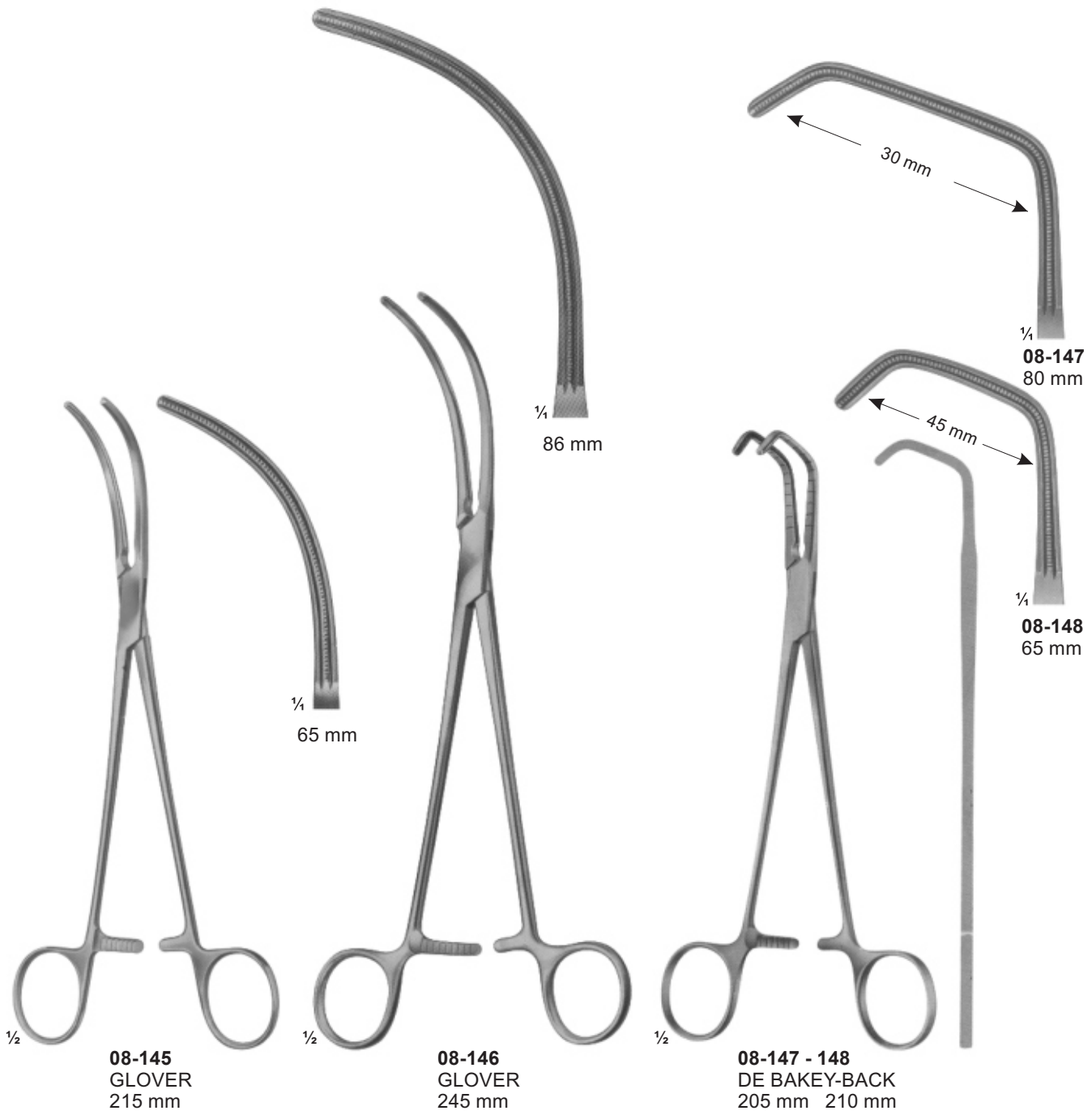



$\frac{1}{4}$
08-149
86 mm

$\frac{1}{4}$
08-150
86 mm

$\frac{1}{4}$
08-151
86 mm

$\frac{1}{4}$
08-152
86 mm

08-149 - 151
DE BAKHEY-HARKEN
08-149 - 255 mm
08-150 - 245 mm
08-151 - 245 mm
08-152 - 245 mm



$\frac{1}{2}$
08-153 - 157
DE BAKHEY

Total Length: 220 mm
Length of jaws: 85 mm

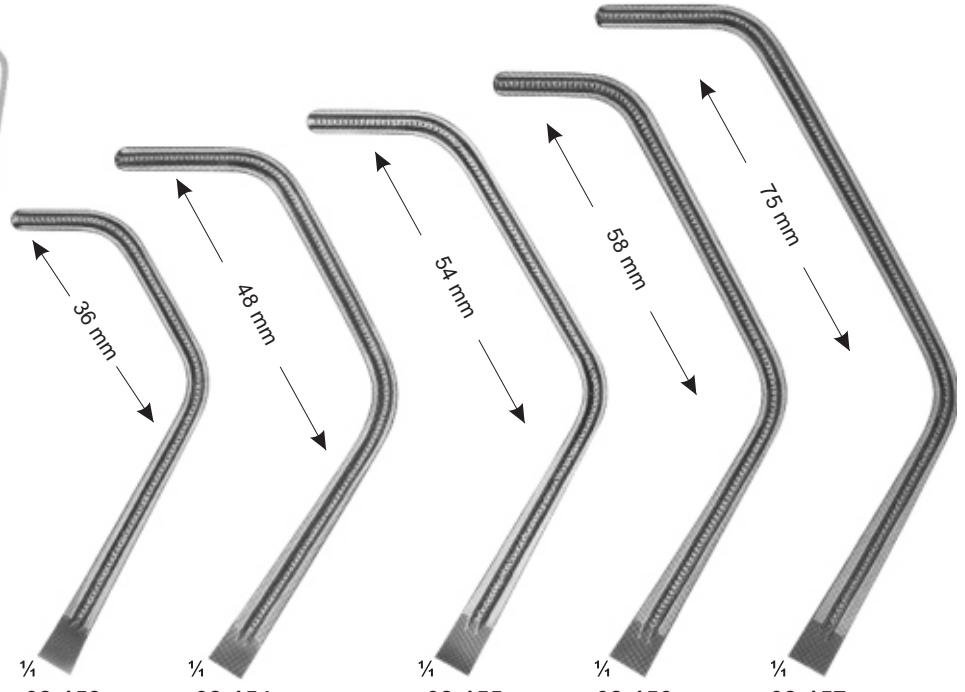

$\frac{1}{4}$
08-153

$\frac{1}{4}$
08-154

$\frac{1}{4}$
08-155

$\frac{1}{4}$
08-156

$\frac{1}{4}$
08-157

256 mm
95 mm

270 mm
99 mm

270 mm
103 mm

280 mm
119 mm



$\frac{1}{2}$
08-158 - 160
 DE BAKEY-SATINSKY
 235 mm, 240 mm, 245 mm

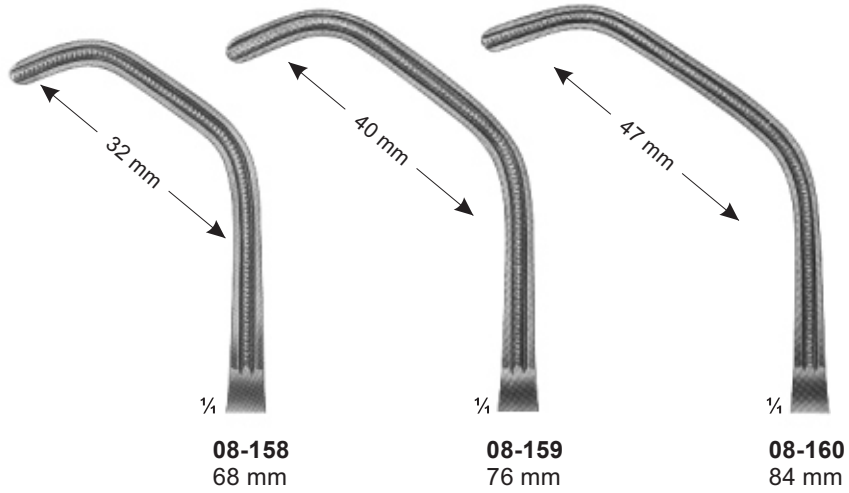

$\frac{1}{4}$
08-158
 68 mm

$\frac{1}{4}$
08-159
 76 mm

$\frac{1}{4}$
08-160
 84 mm



$\frac{1}{2}$
08-161 - 262
 DE BAKEY
 170 mm, 165 mm

$\frac{1}{4}$
08-161
 50 mm

$\frac{1}{4}$
08-162
 50 mm



$\frac{1}{2}$
08-163
 DE BAKEY
 165 mm

$\frac{1}{4}$
 50 mm



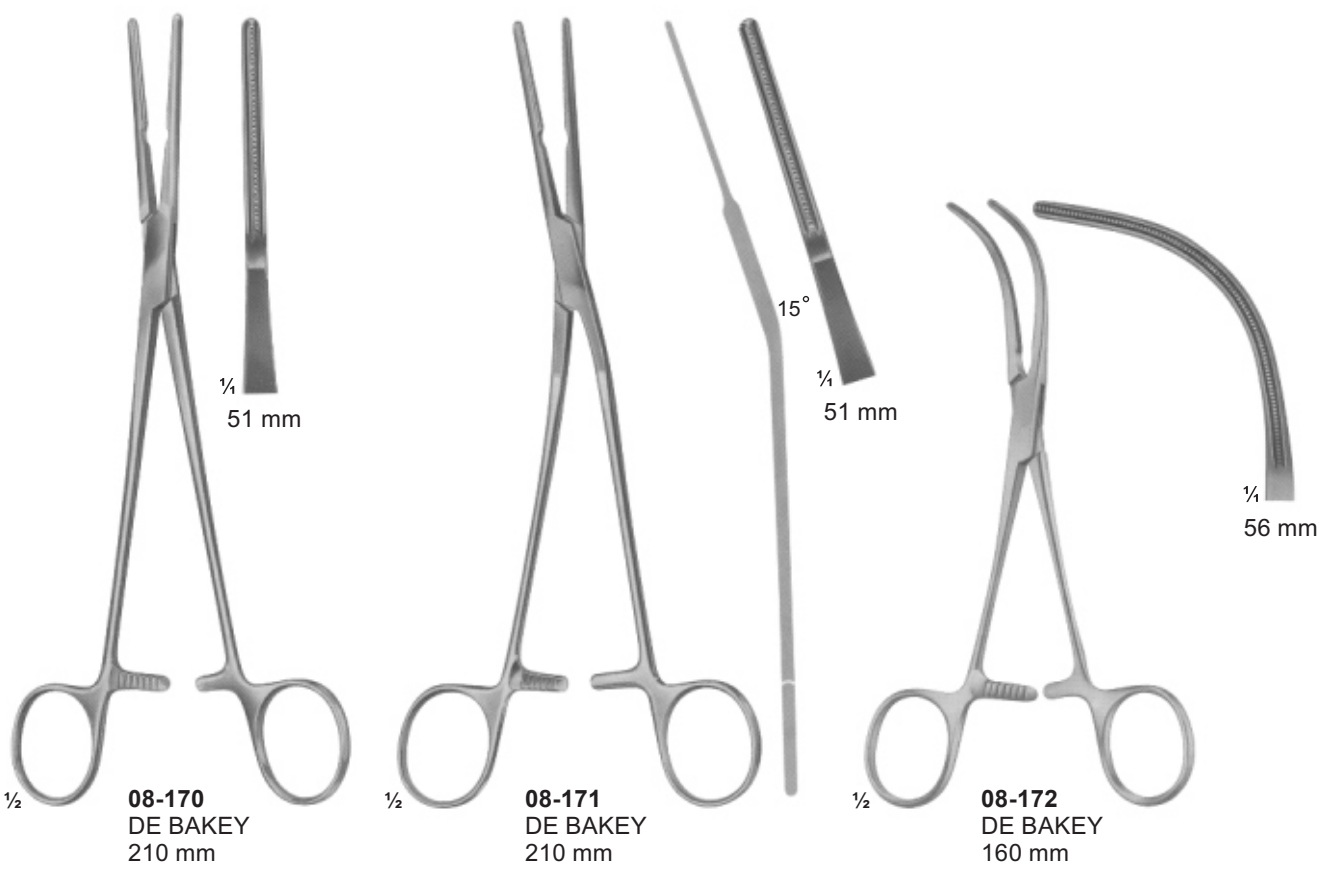
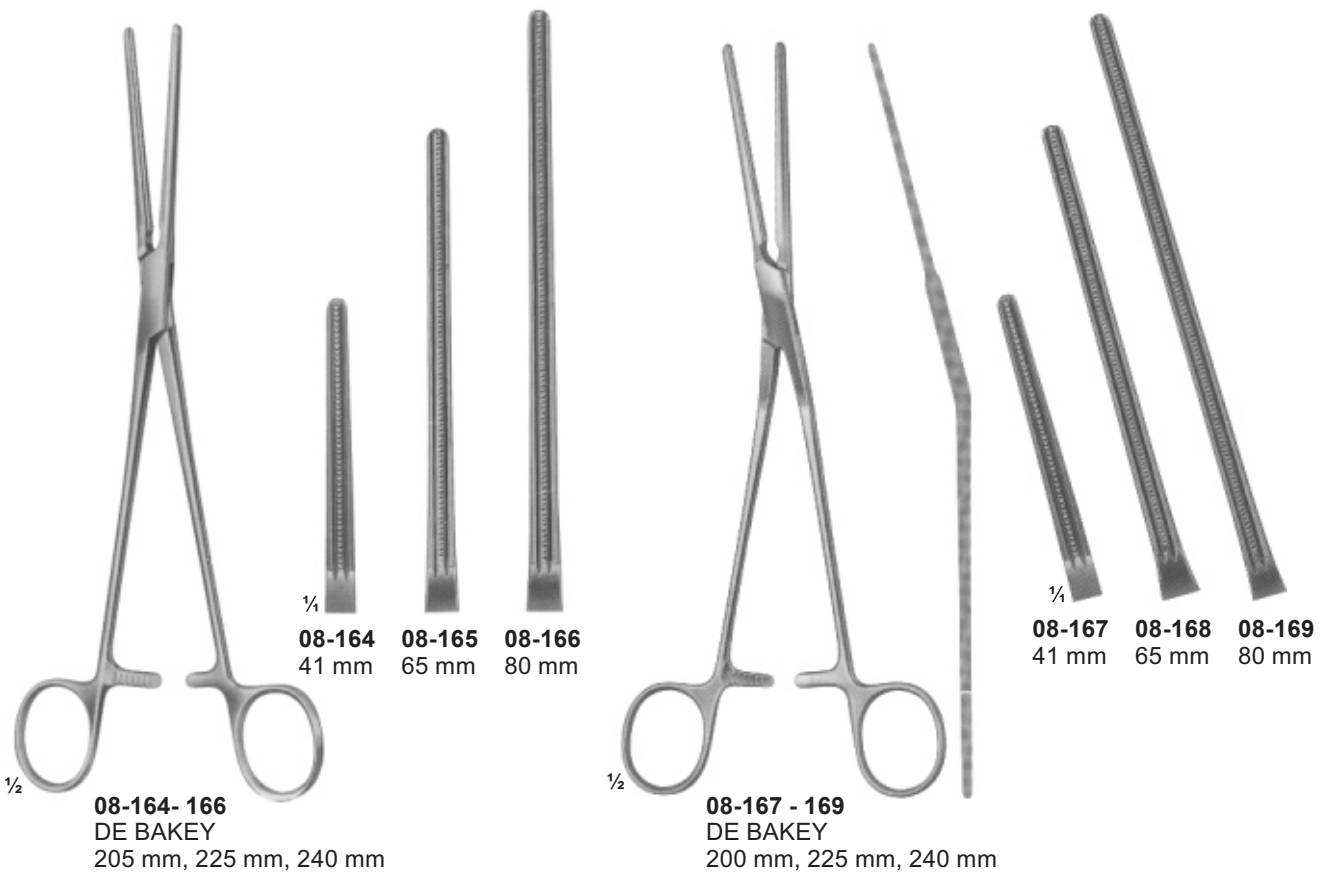

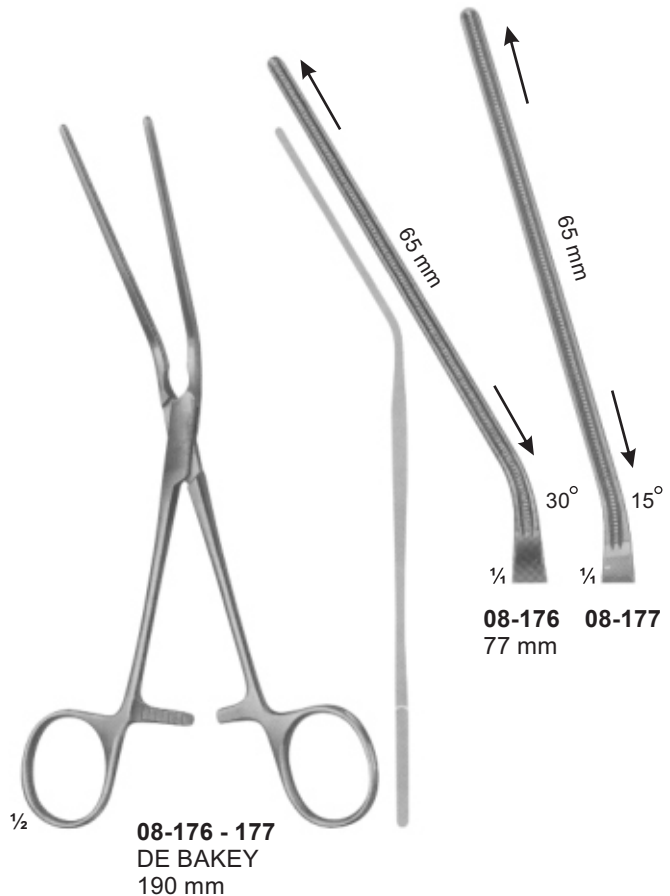
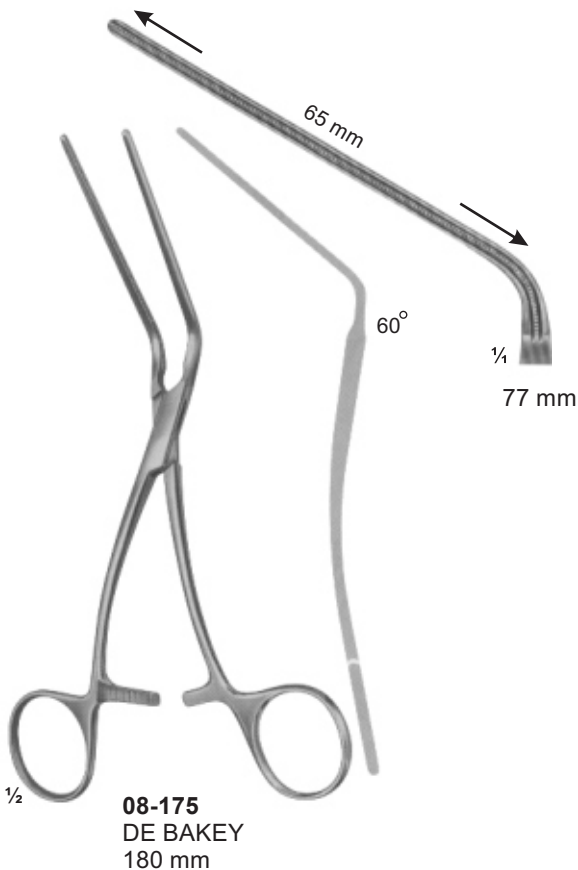
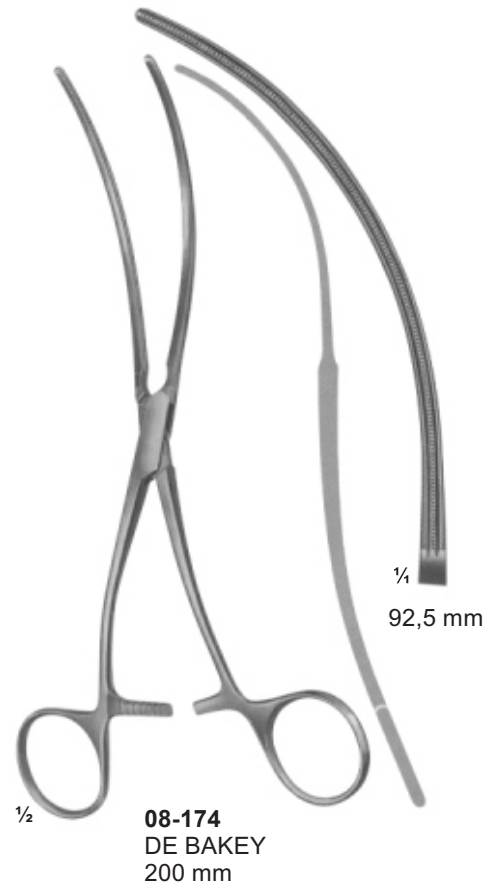
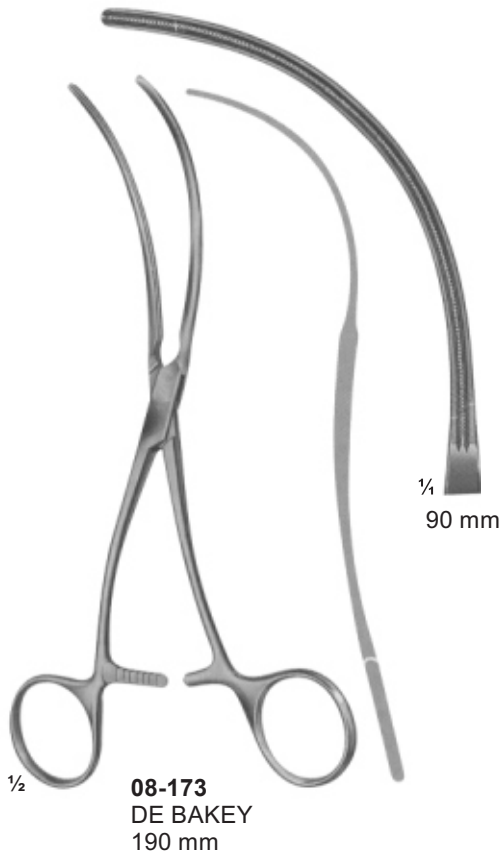

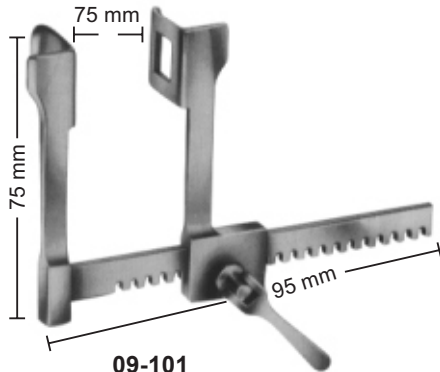

09-101
FINOCHIETTO
 18X21 mm

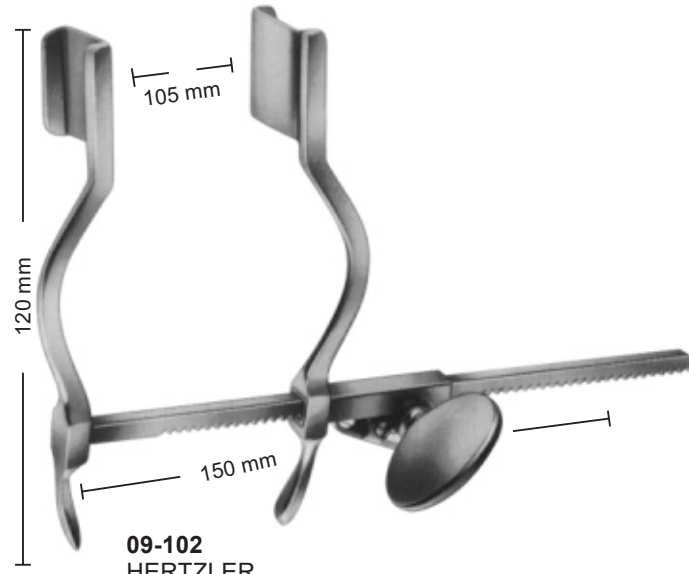

09-102
HERTZLER
 20X25 mm

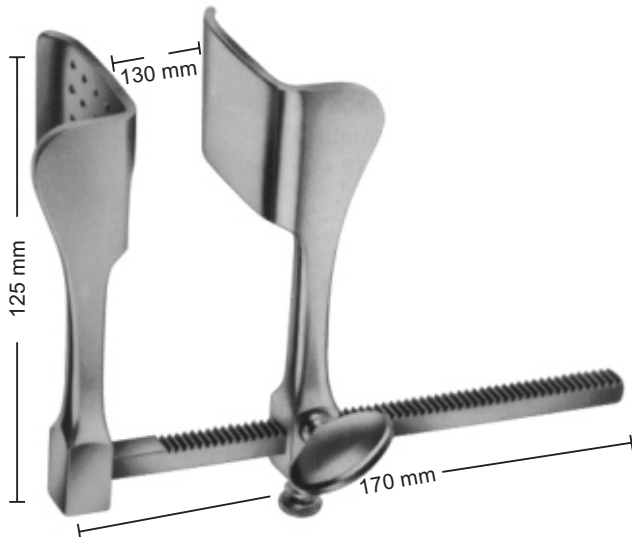

09-103
TUFFIER
 Blades
 43X53 mm

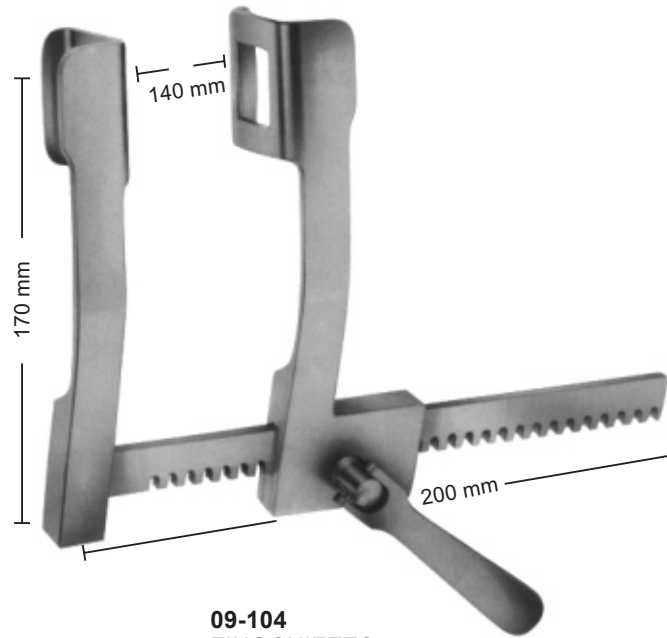

09-104
FINOCHIETTO
 Blades
 36X45 mm

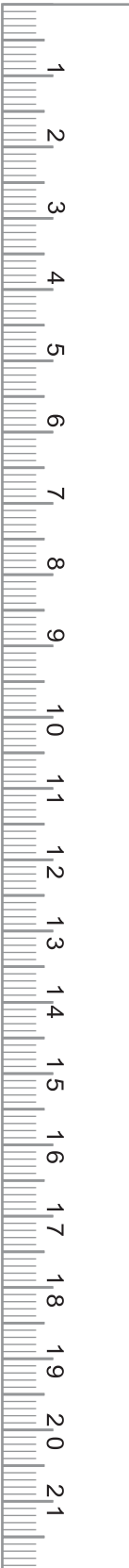

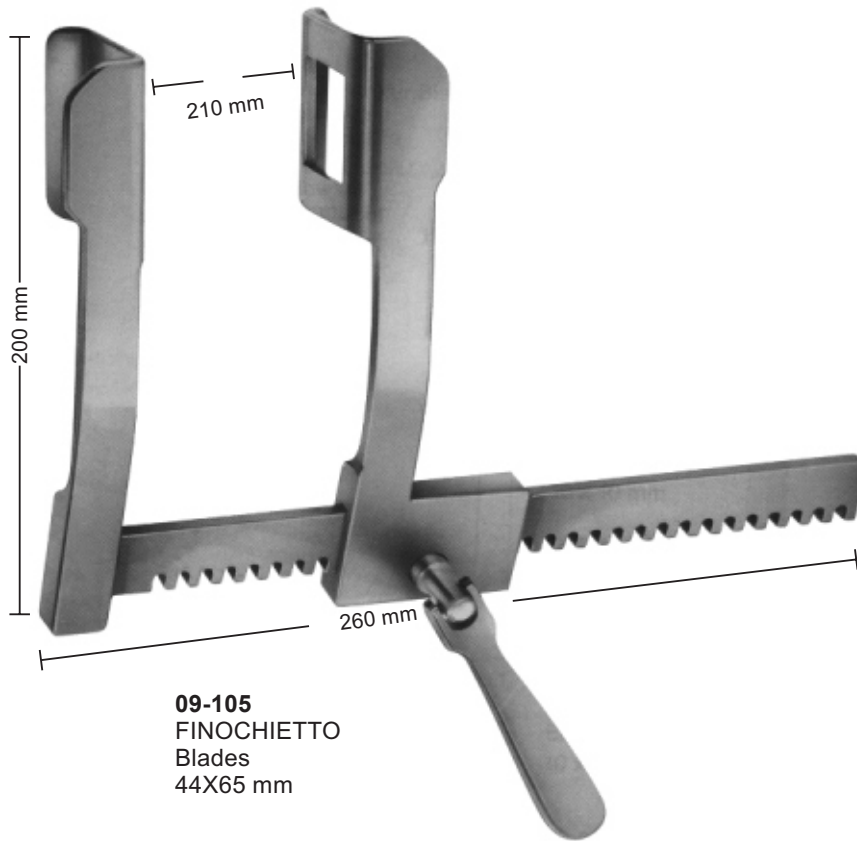

09-105
FINOCHIETTO
Blades
44X65 mm

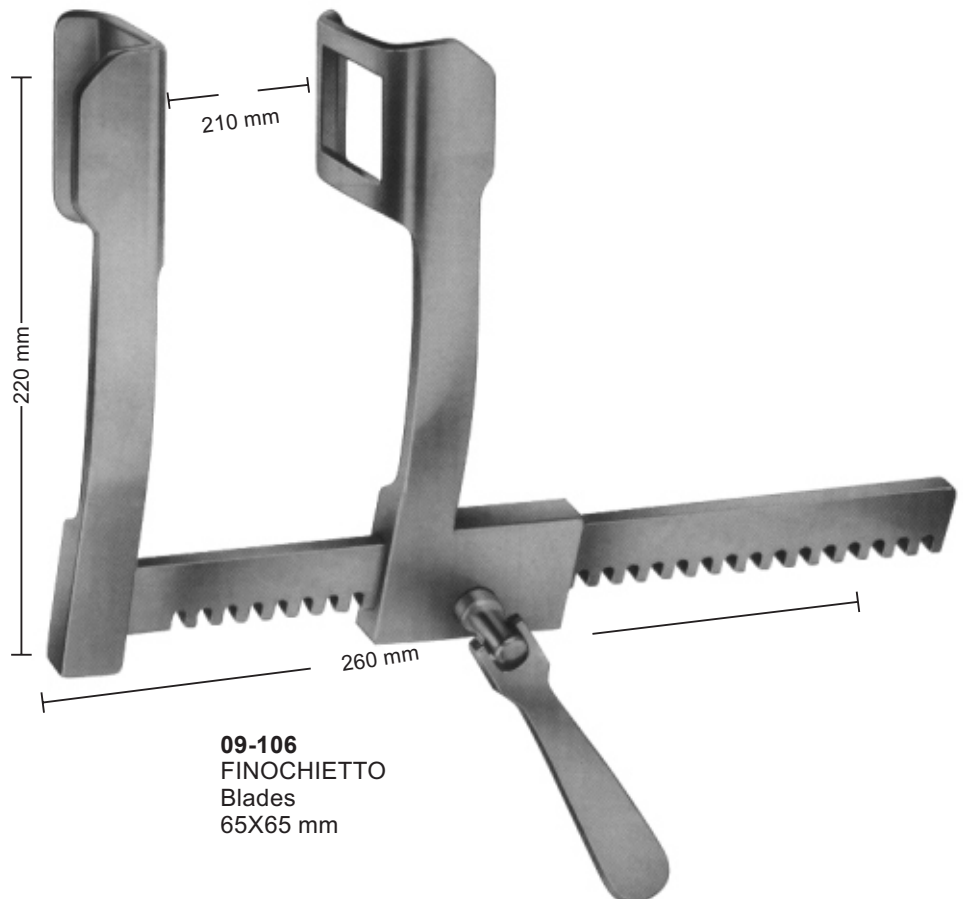

09-106
FINOCHIETTO
Blades
65X65 mm

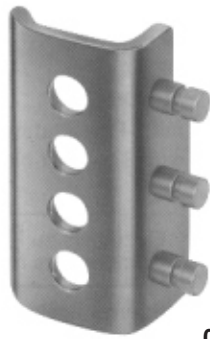

09-108
 Blades
 46x67 mm



09-109
 Blades
 80x67 mm



09-110
 Blades
 46x67 mm

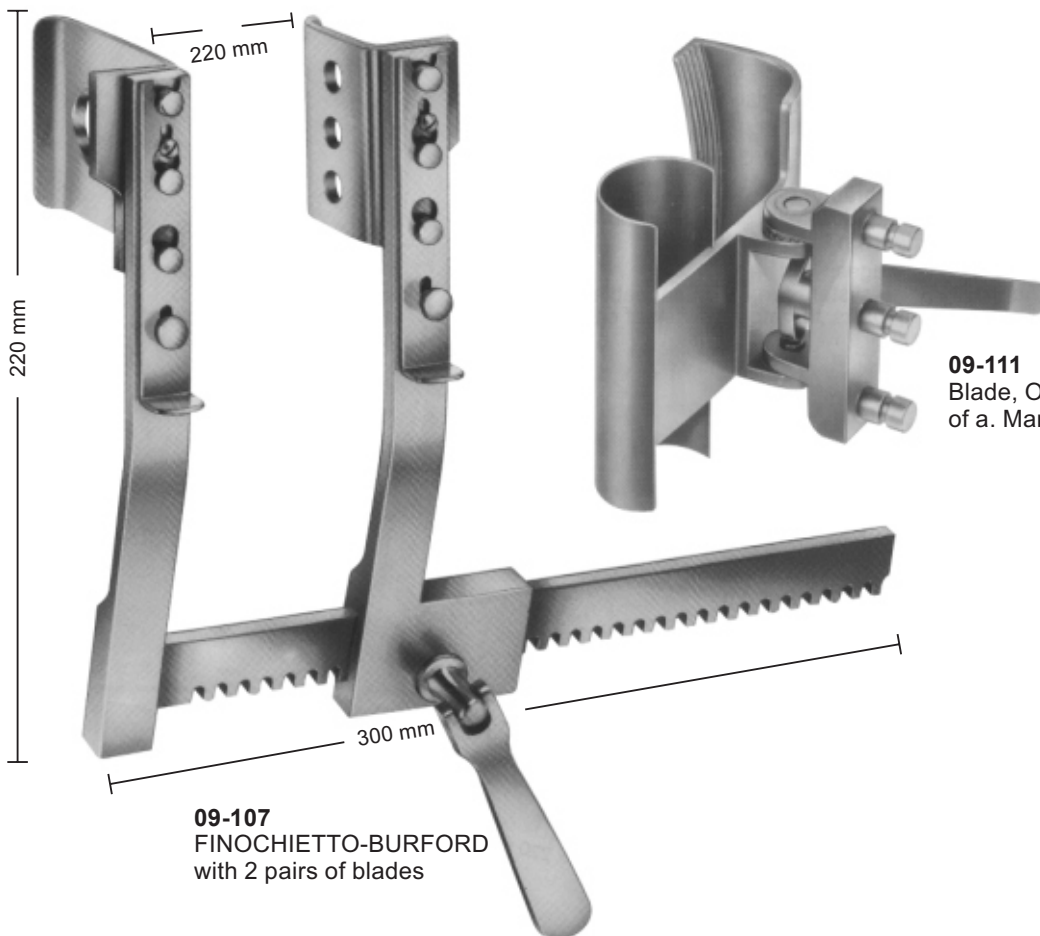

09-107
FINOCHIETTO-BURFORD
 with 2 pairs of blades

09-111
 Blade, Only, for preparation
 of a. Mammaria, 25.5x80mm

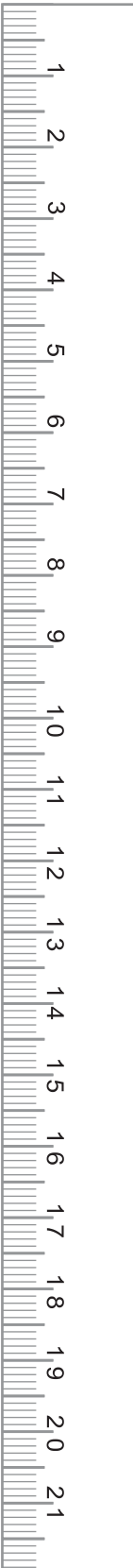

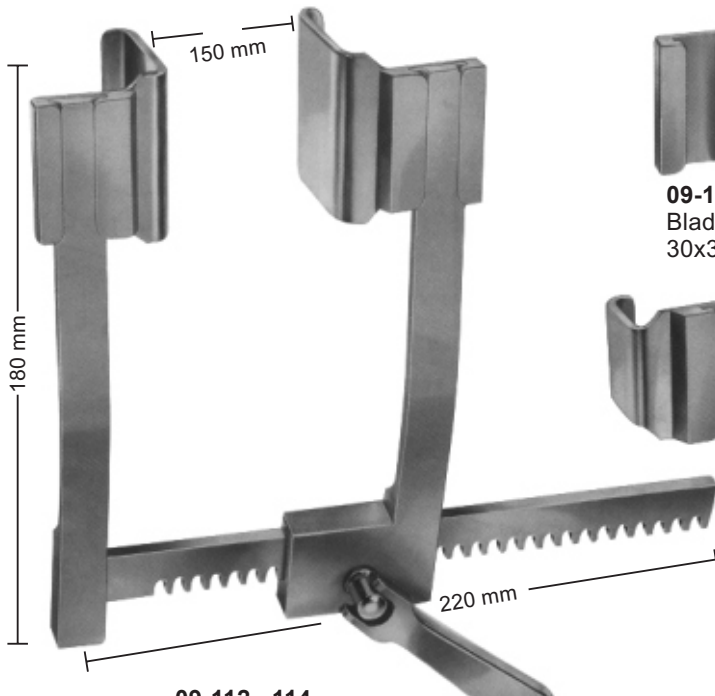

09-112 - 114
DE-BAKEY
with 3 pairs of blad

09-112
Blades
30x30 mm

09-113
Blades
40x40 mm

09-114
Blades
50x50 mm

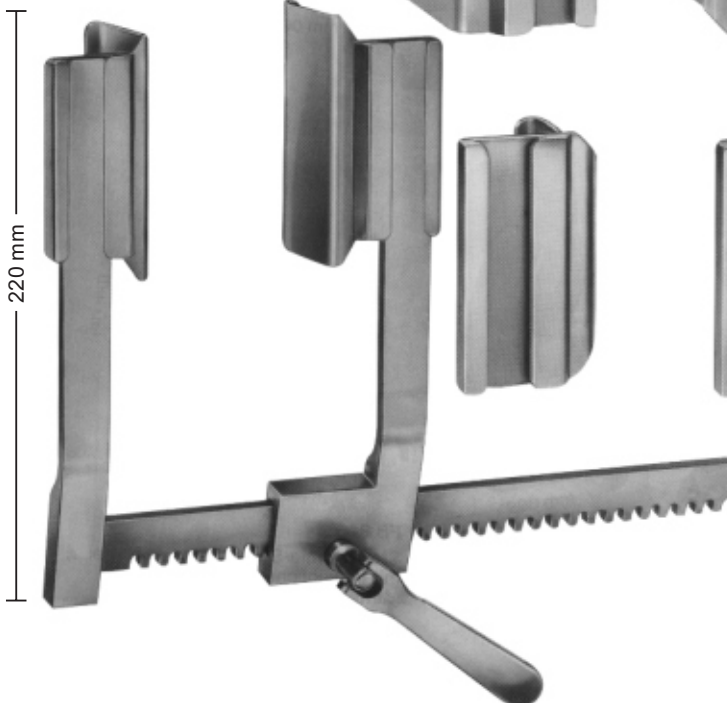
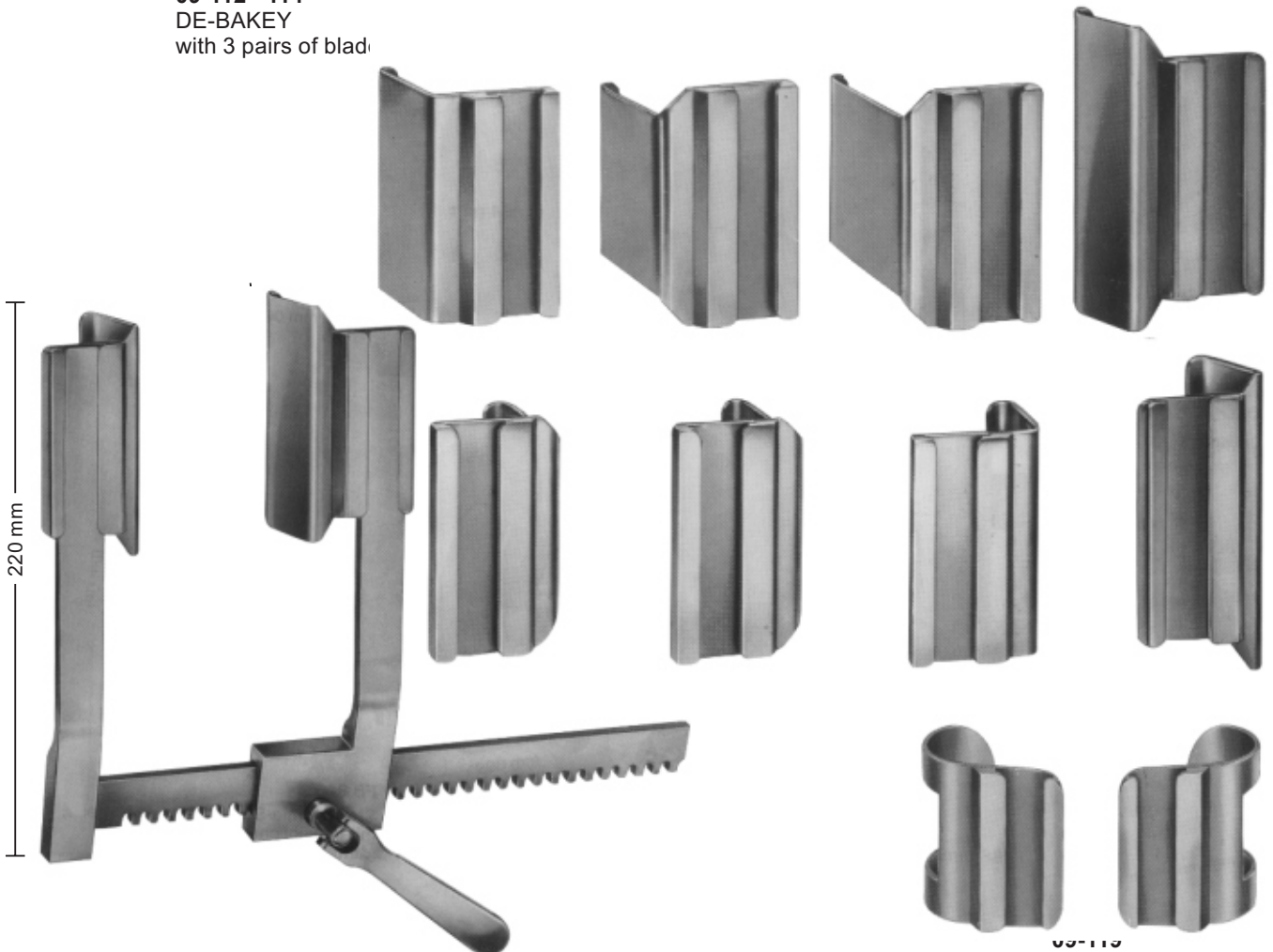

09-115
Sternotomy Blades
50x660 mm

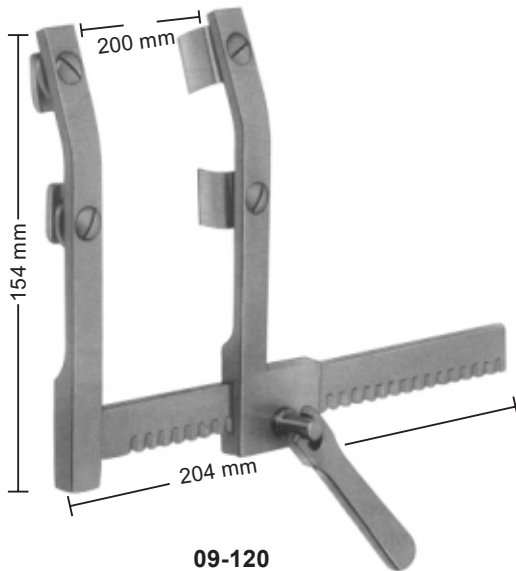

09-120
MORSE
Sternotomy spreader
for children, with moveable
double, each blade
12x20 mm

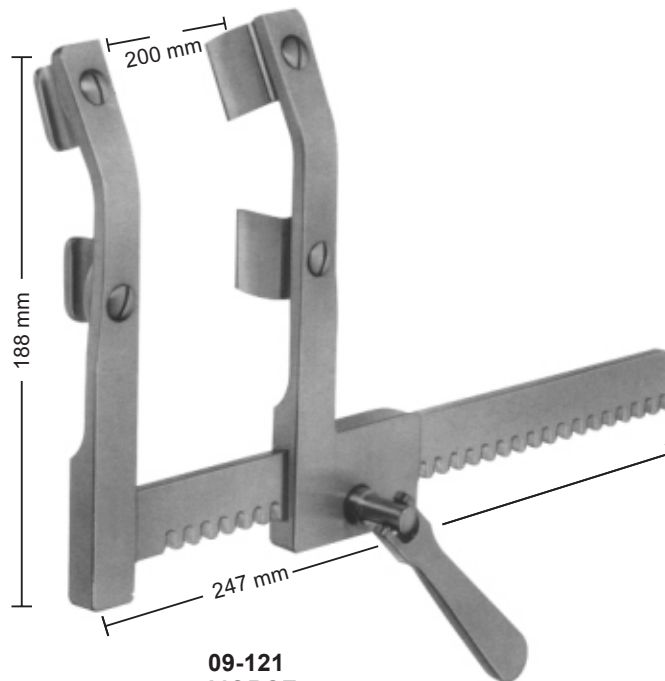

09-121
MORSE
Sternotomy spreader
for adults, with moveable
double, each blade
19x19 mm

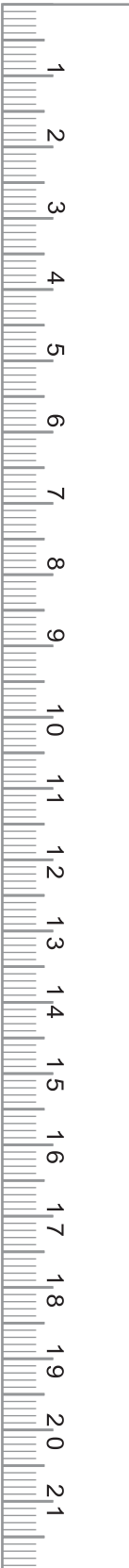

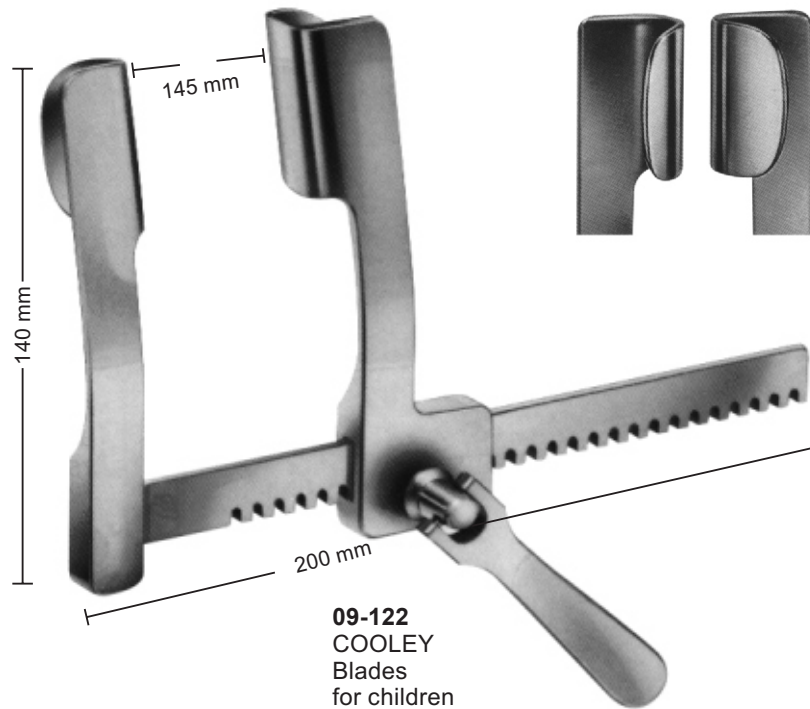

09-122
COOLEY
Blades
for children
21x45mm

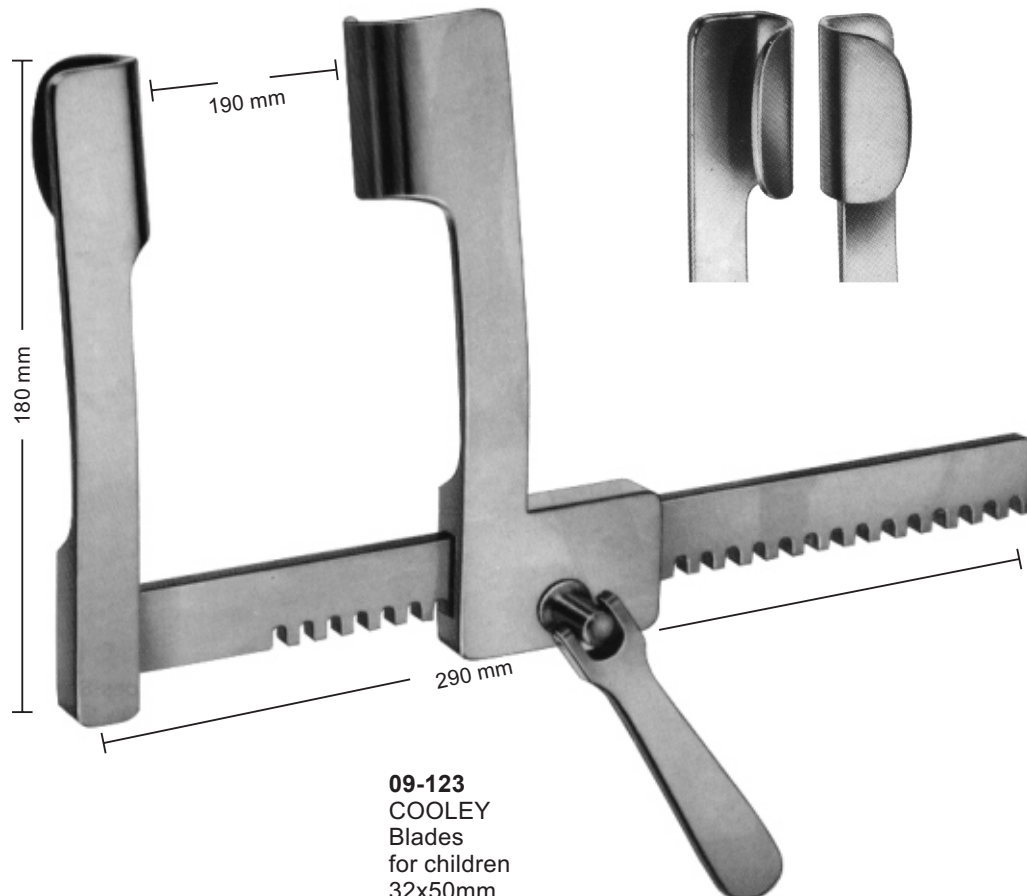

09-123
COOLEY
Blades
for children
32x50mm

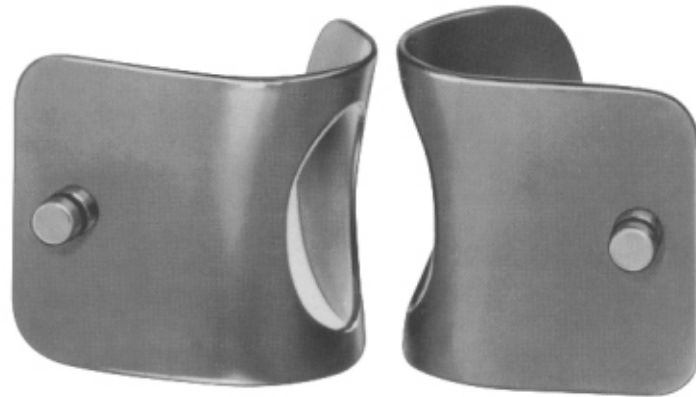

09-125
 Blades
 75x75 mm



09-126
 Blades
 42x65 mm



Blades with Ball Snap System
 Delivery: in Pairs

- 09-124 - 126**
 Thoraxsperrer (Mercedes-Sperrer)
 complete consisting of:
09-124 Retractor only
09-125 1 Pair of blades 42x65 mm
09-126 1 Pair of blades 75x75 mm





09-127
SELLORS
Rib spreader-and contractor
with swivel blades
200 mm



09-128
BAILEY
150 mm



09-129
for children

09-130
for children

09-129 - 130
BAILEY
200 mm

90° upwards cutting

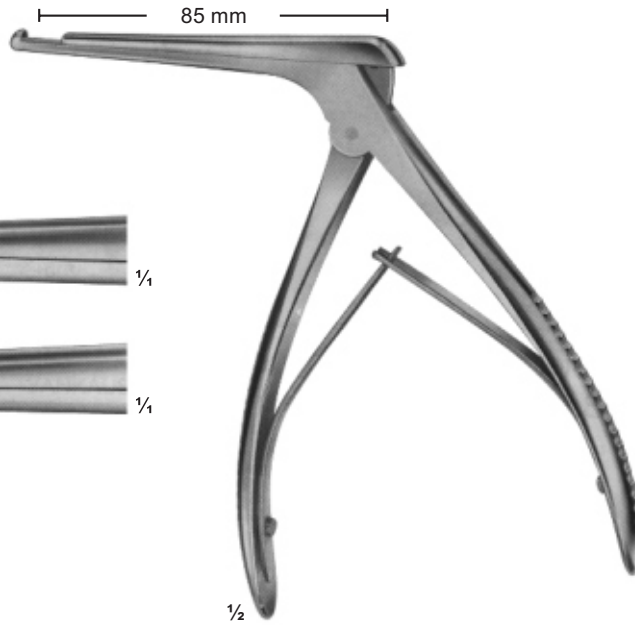

10-101
4 mm



1/4

10-102
5 mm



1/4

10-101 - 102
KERRISON

90° upwards cutting

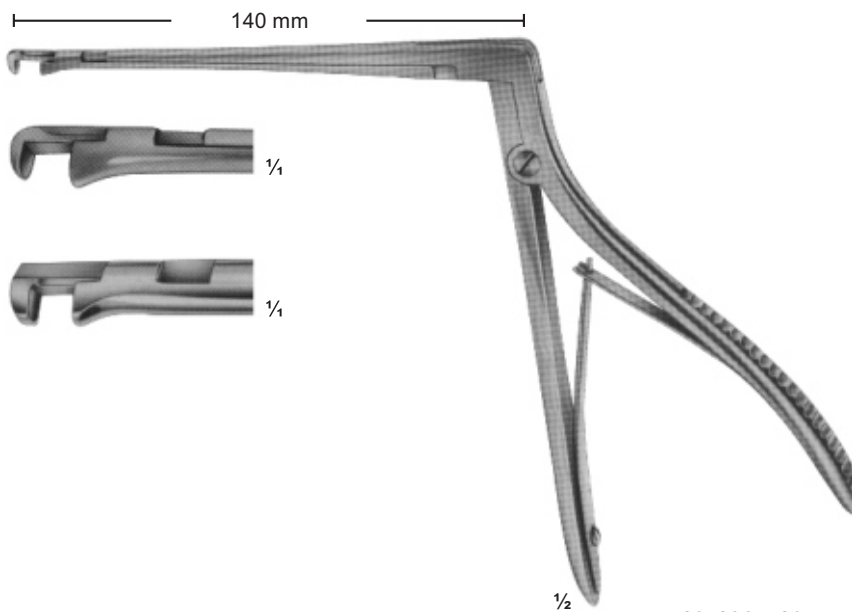

10-103
3,3 mm



1/4

10-104
4,0 mm



1/4









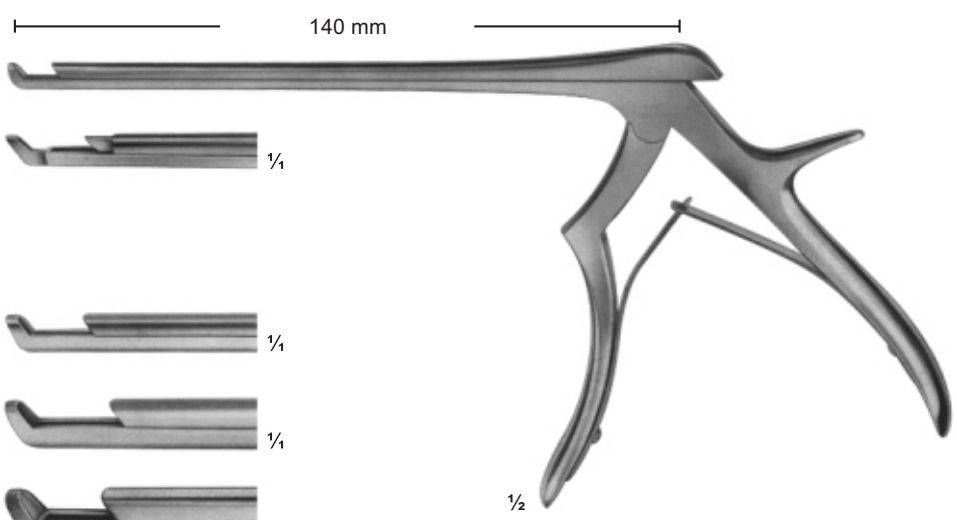

10-103 - 104
HAJEK-KOFLER





130° upwards cutting









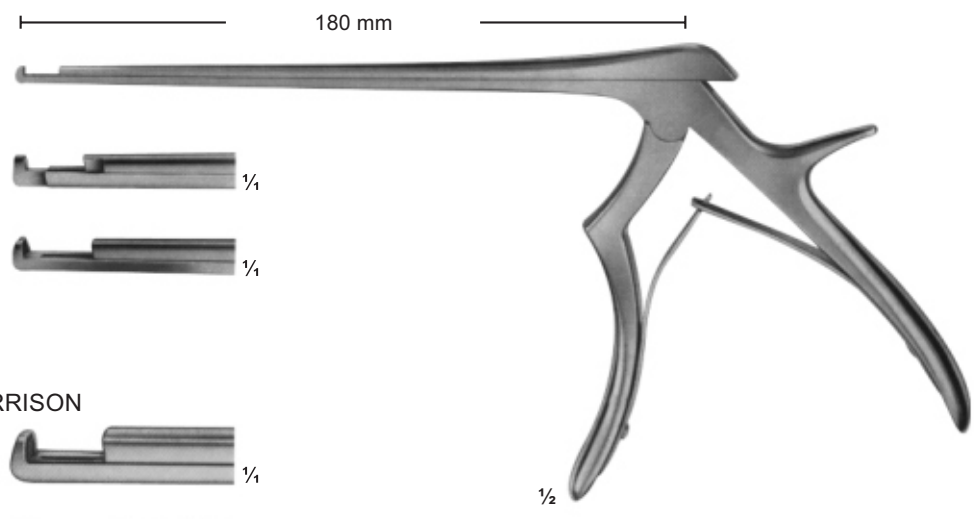



- 10-105**
1 mm   1/4
- 10-106**
2 mm   1/4
- 10-107**
3 mm   1/4
- 10-108**
4 mm   1/4
- 10-109**
5 mm   1/4

10-105 - 109
KERRISON-JACOBY

90° upwards cutting



- 10-110**
1 mm   1/4
- 10-111**
2 mm   1/4
- FERRIS-SMITH-KERRISON**
- 10-112**
3 mm   1/4
- 10-113**
4 mm   1/4
- 10-114**
5 mm   1/4

10-110 - 114
KERRISON-JACOBY

Angled positions for rongeurs

- 10-115**
3,0 mm
- 10-116**
3,6 mm
- 10-117**
4,2 mm
- 10-118**
4,8 mm
- 10-119**
5,8 mm

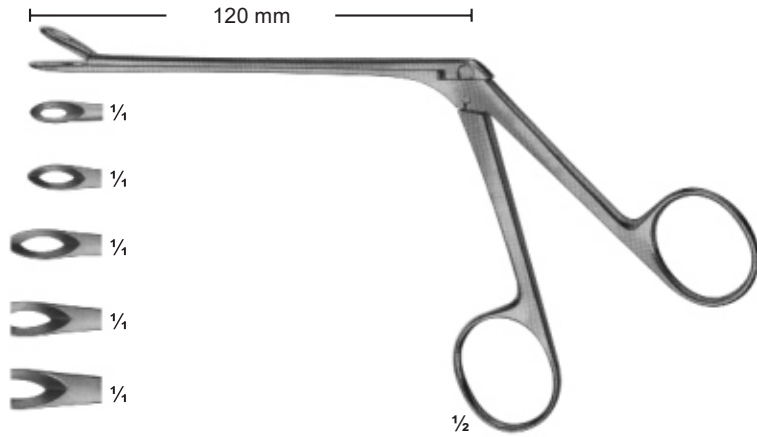

10-115 - 119
WEIL-BLAKESLEY

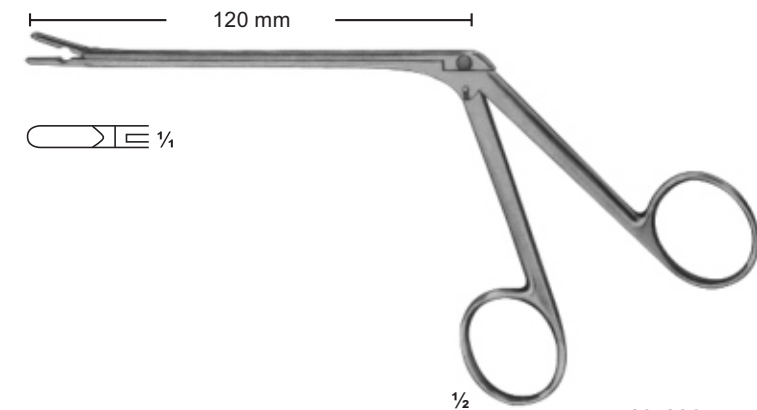

10-120
TAKAHASHI
3 mm

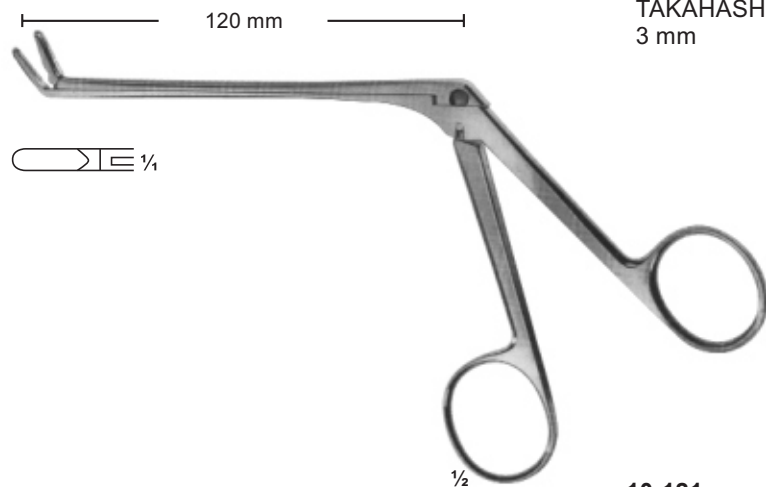

10-121
TAKAHASHI
3 mm

130°





10-122
2 X 10 mm

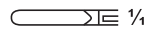

10-123
3 X 10 mm

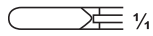

10-124
4 X 10 mm

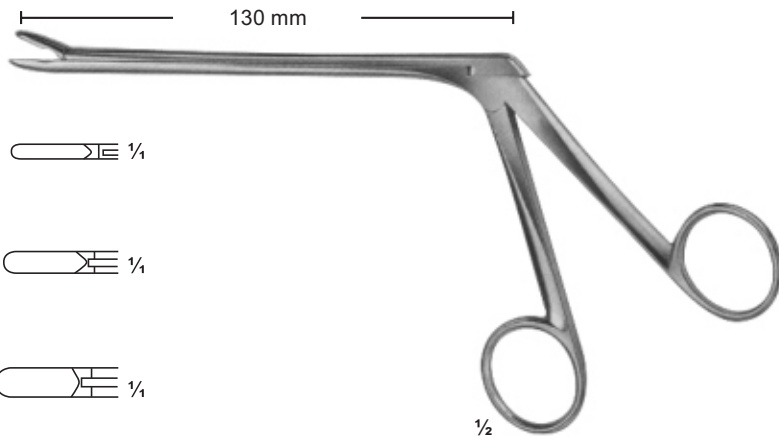

10-122 - 124
LOVE-GRUENWALD

10-125
2 mm

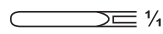

10-126
3 mm



10-127
4 mm

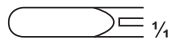

10-128
5 mm

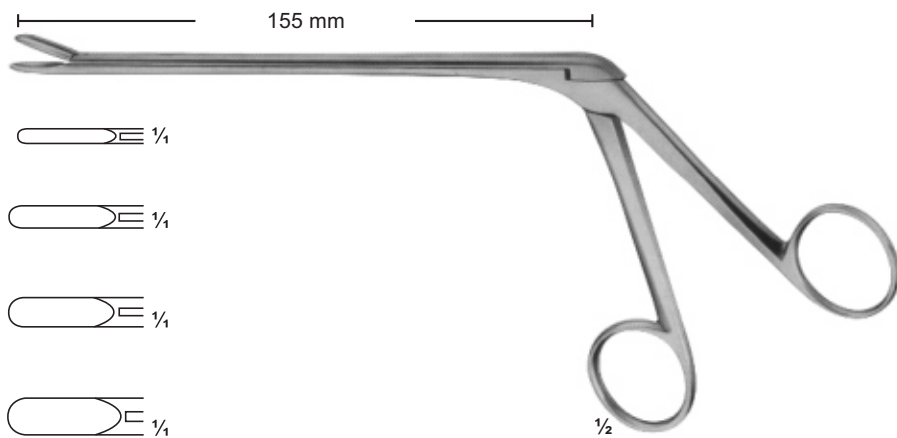

10-125 - 128
CASPAR

10-129
2 mm



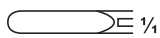

10-130
3 mm

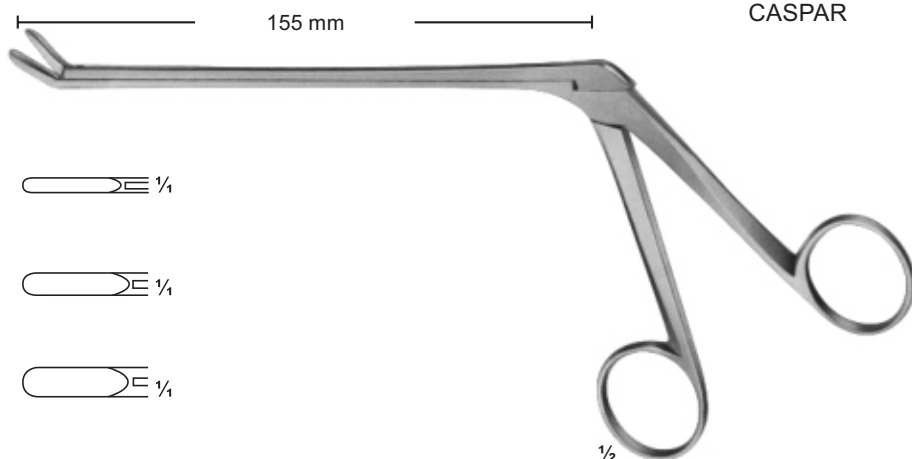

10-131
4 mm



10-129 - 131
CASPAR

Length of shaft 140 mm	Length of shaft 160 mm	Length of shaft size of jaws 185 mm		
10-132	10-134	10-136	3 X12 mm	 1/4
10-133	10-135	10-137	4 X14 mm	 1/4

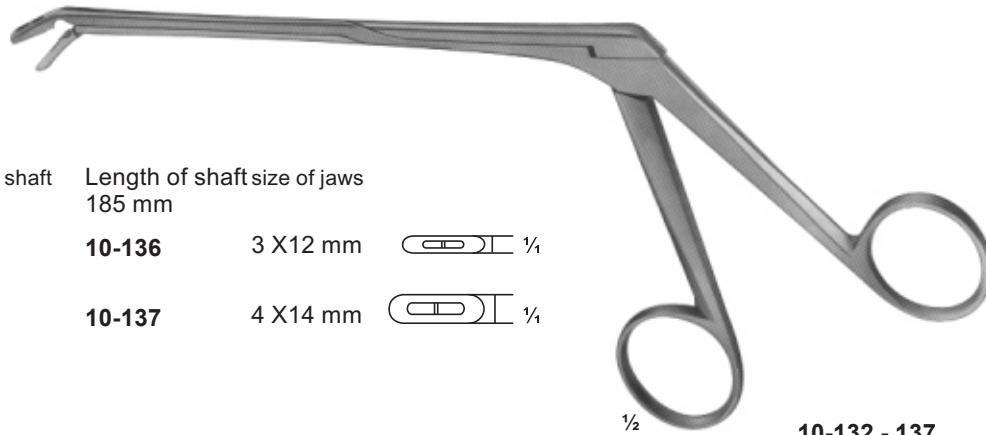

10-132 - 137
GUSHING

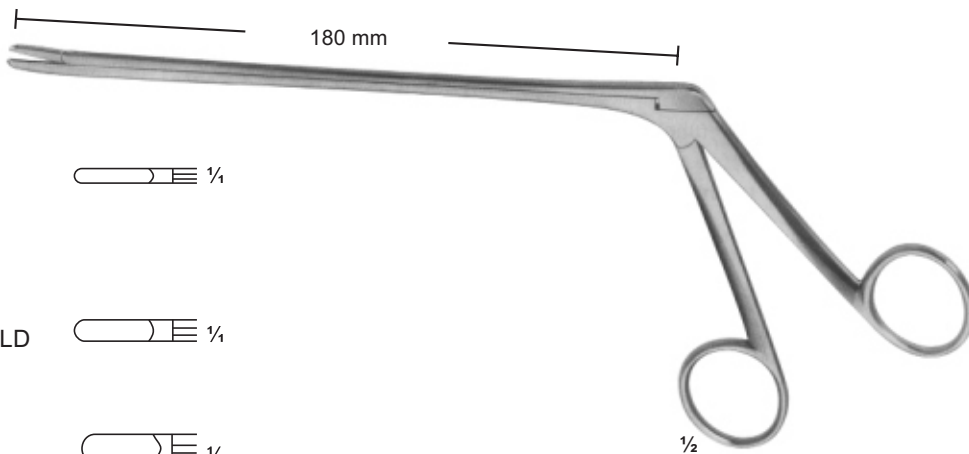

10-138 - 140
LOVE-GRUENWALD

10-138
2 X 10 mm
GUSHING

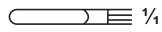

10-139
3 X 10 mm
LOVE-GRUENWALD

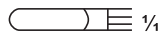

10-140
4 X 10 mm
SPURLING

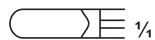

10-141
3 X 10 mm
LOVE-GRUENWALD



10-142
4 X 10 mm
SPURLING

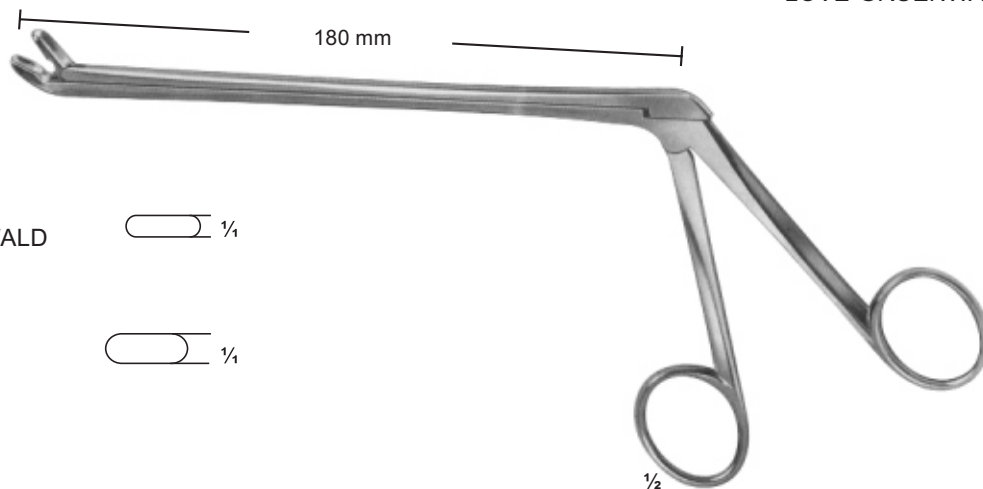

10-141 - 142
LOVE-GRUENWALD

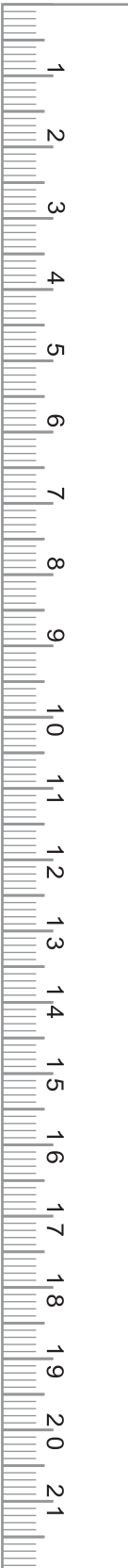



10-143
3 X 10 mm
LOVE-GRUENWALD

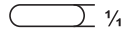

10-144
4 X 10 mm
SPURLING

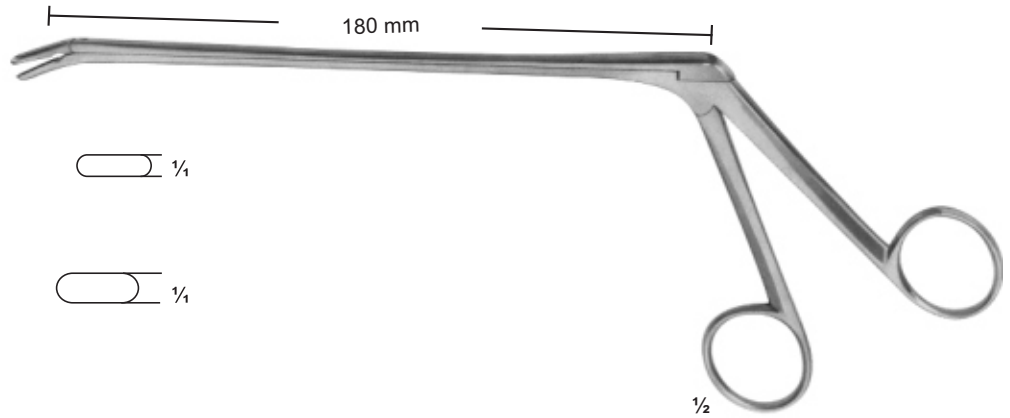

10-143 - 144
LOVE-GRUENWALD

10-145
7 mm

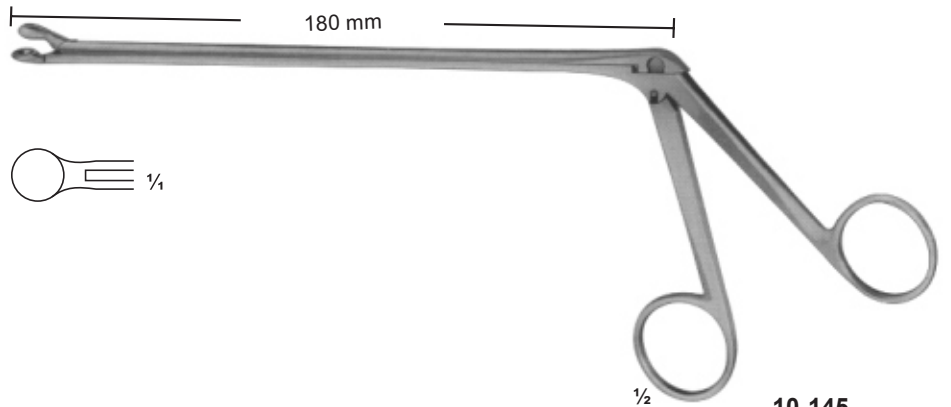
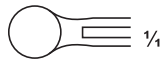

10-145
OLDBERG

10-146
YASARGIL
2,2 mm



10-147
YASARGIL
3,5 mm

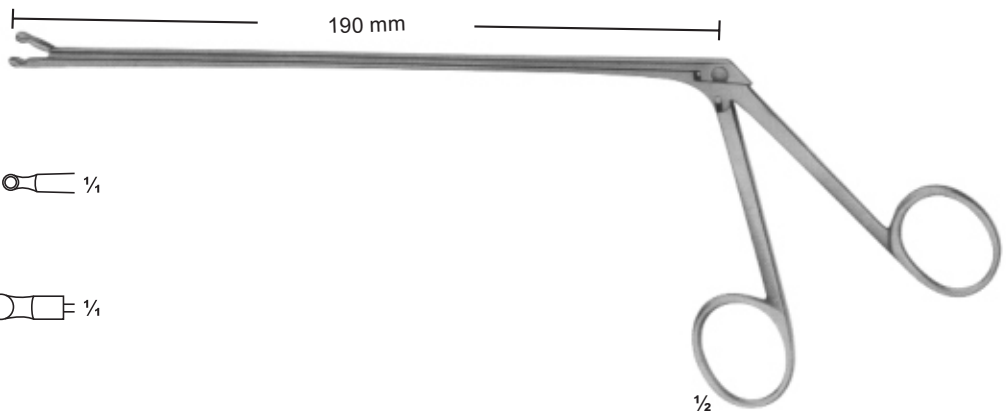

10-146 - 147

10-148
4 mm

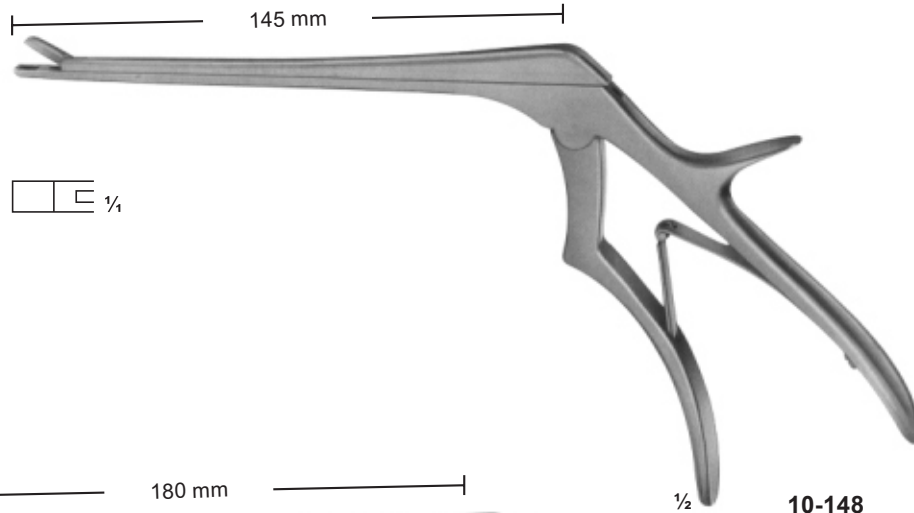

10-148
CASPAR

10-149
4 mm

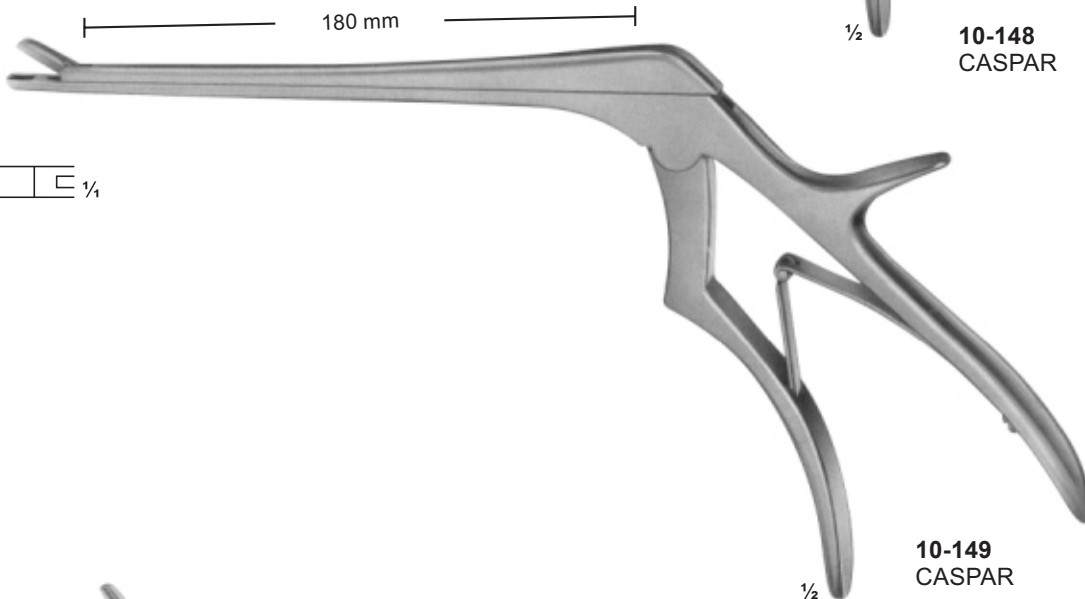

10-149
CASPAR

10-150
5,5 mm

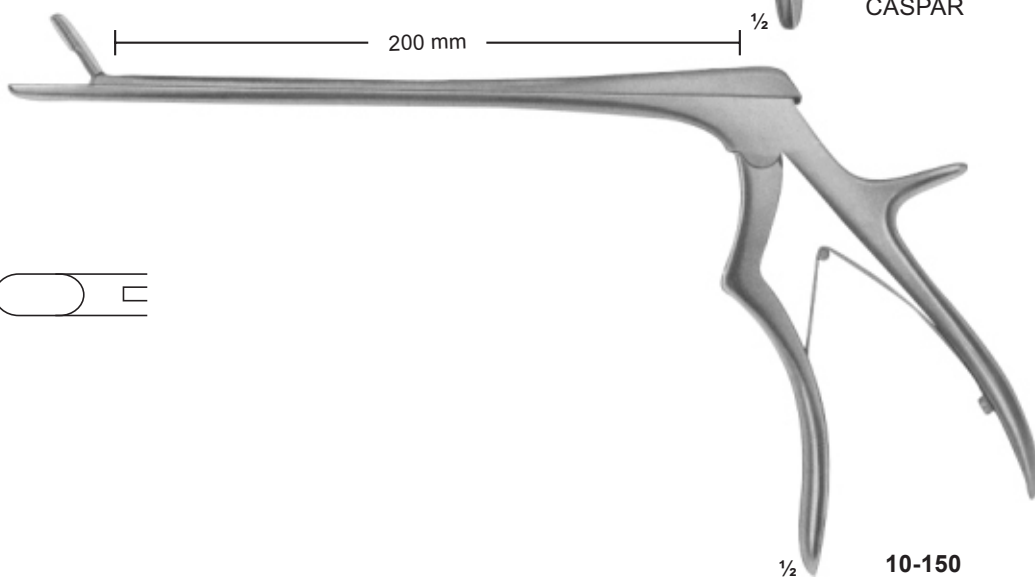

10-150
WAGNER



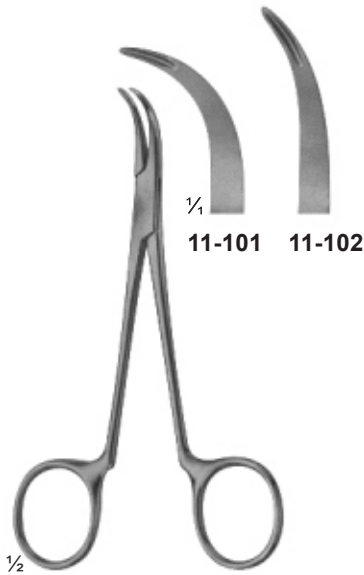

11-101 - 102
 Synovcetomy rongeur
 width of jaws 1.2 mm
 130 mm

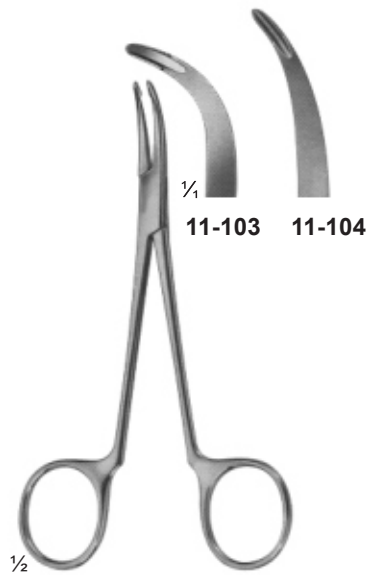

11-103 - 104
 Synovcetomy rongeur
 width of jaws 2.0 mm
 130 mm

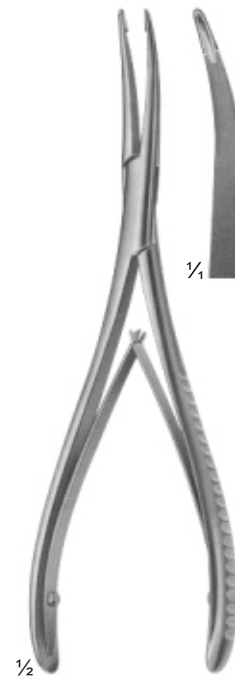

11-105
STELLBRINK
 Synovectomy rongeur
 175 mm

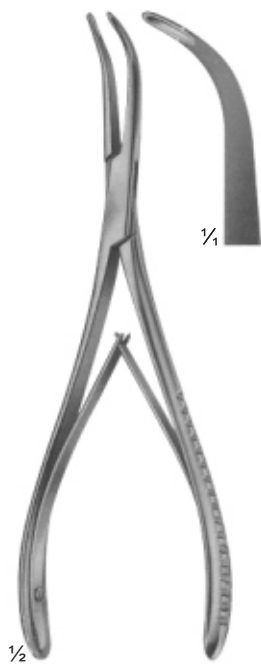

11-106
STELLBRINK
 Synovectomy rongeur
 170 mm



11-107
LURE-FRIEDMANN
 145 mm

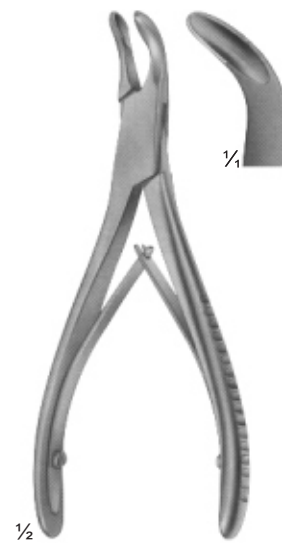

11-108
 140 mm



11-109
LURE
150 mm

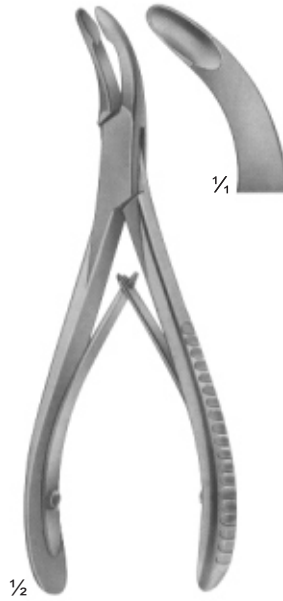

11-110
LURE
155 mm

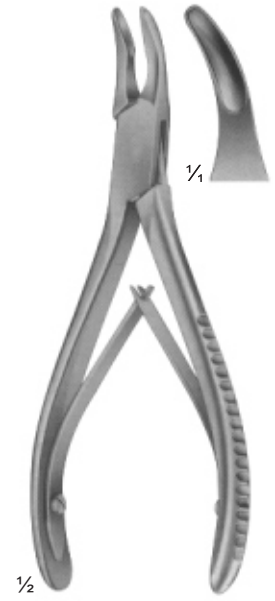

11-111
BLUMENTHAL
155 mm

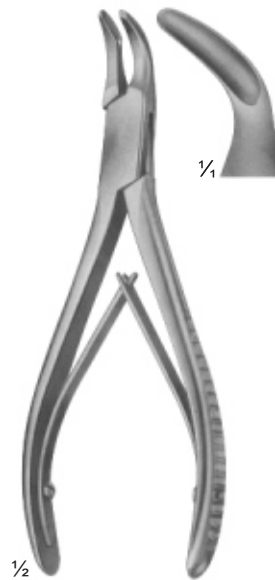

11-112
BLUMENTHAL
150 mm



11-113 - 114
JANSEN
175 mm

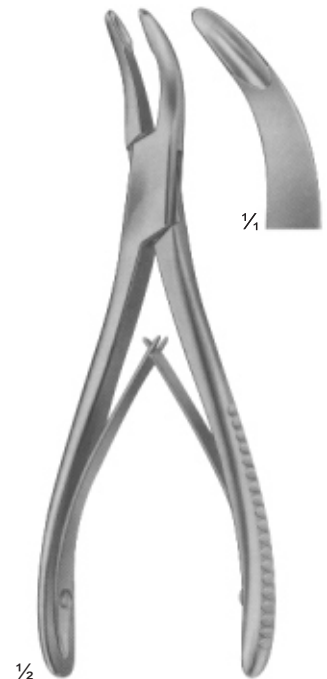

11-114
BANE-HARTMANN
175 mm

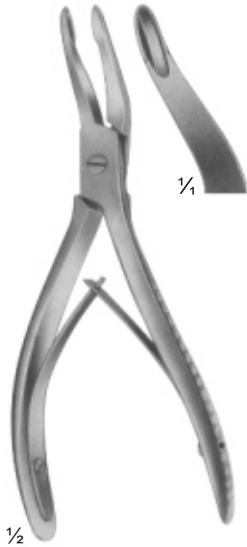

11-115
ALEXANDER
 140 mm

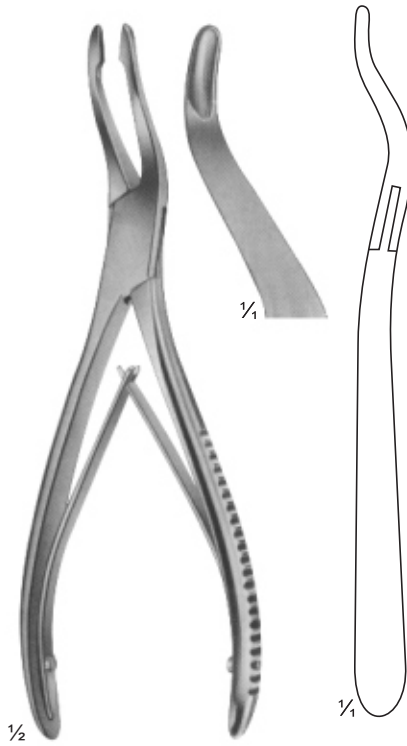

11-116
JANSEN
 190 mm

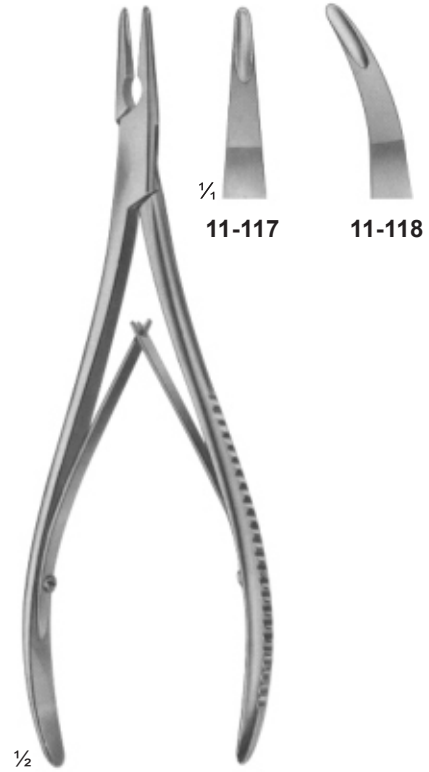

11-117 - 118
LEMPERT
 200 mm

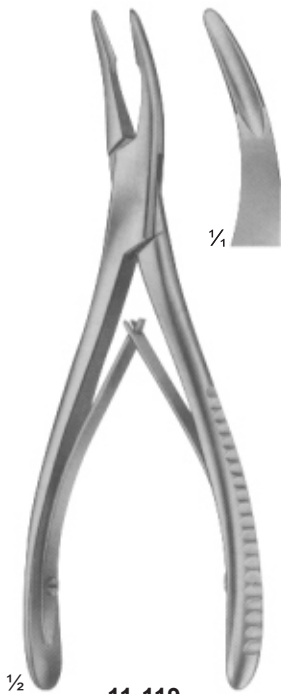

11-119
BEYER
 180 mm

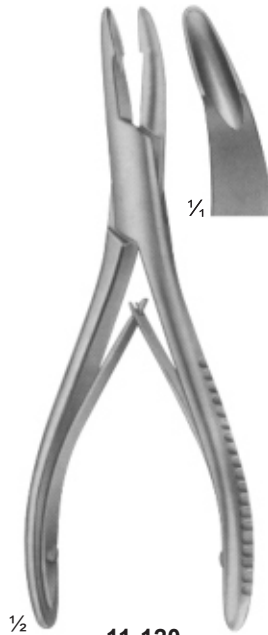

11-120
MEAD
 165 mm

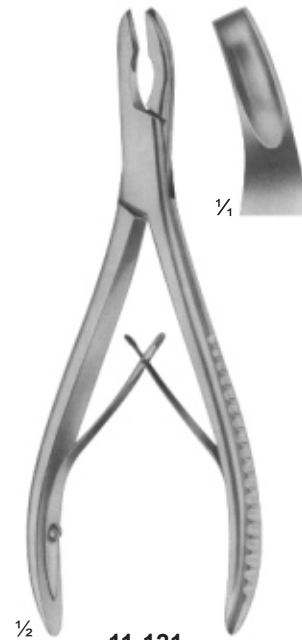

11-121
MEAD
 165 mm



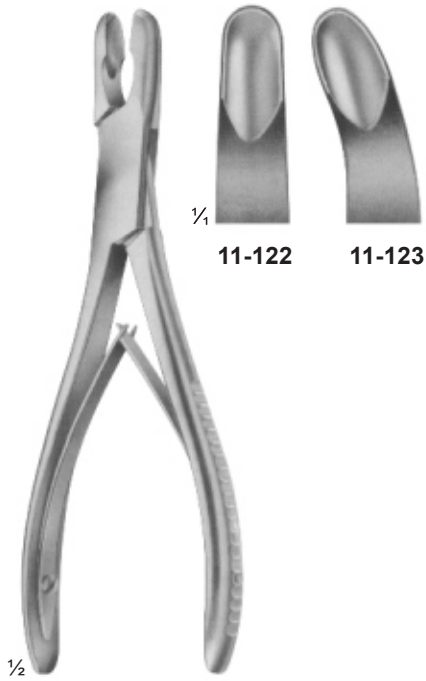

11-122 **11-123**

11-122 - 123
LURE
175 mm

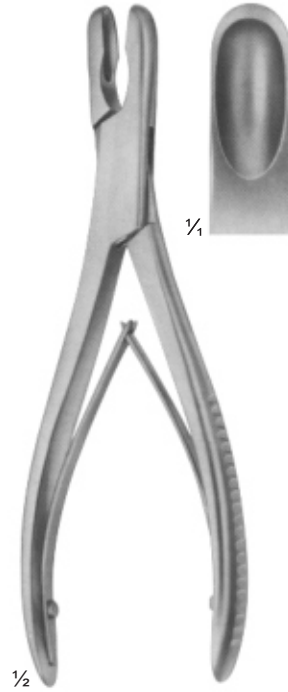

11-124
LURE
180 mm

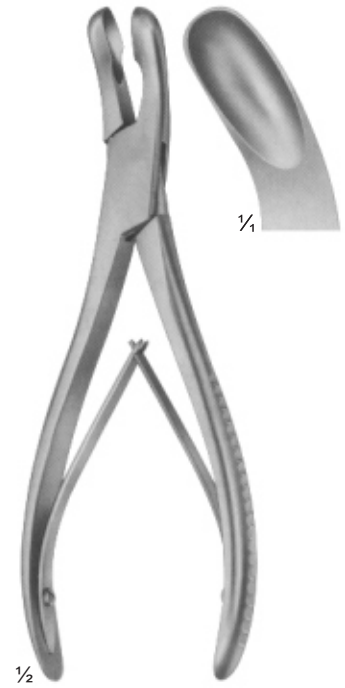

11-125
LURE
180 mm

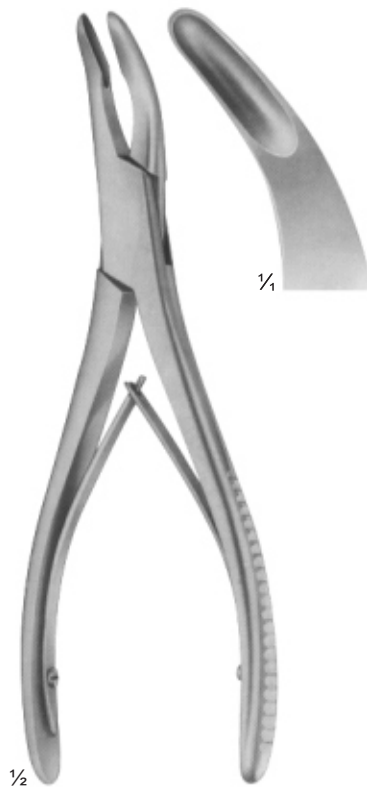

11-126
OLIVECRONA
205 mm



11-127 - 128
BOHLER
155 mm



11-129
MARQUARDT
200 mm

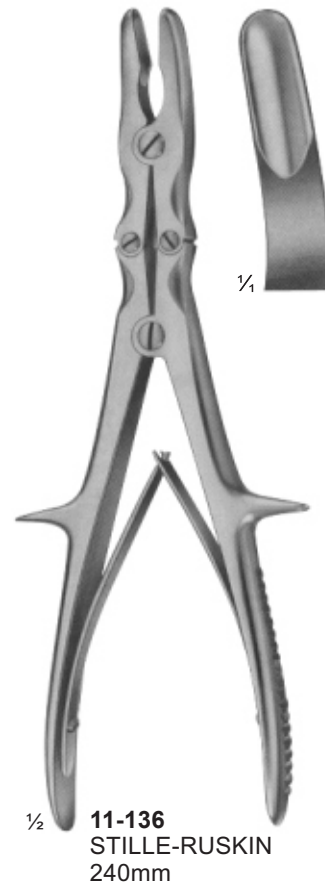
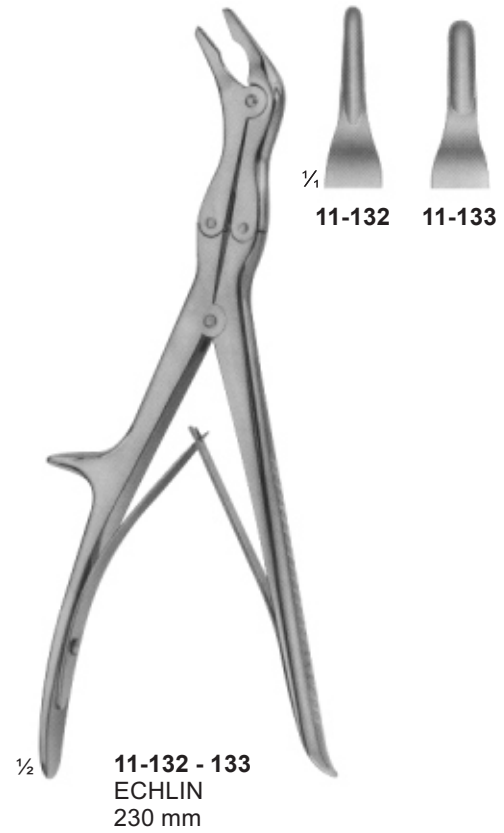
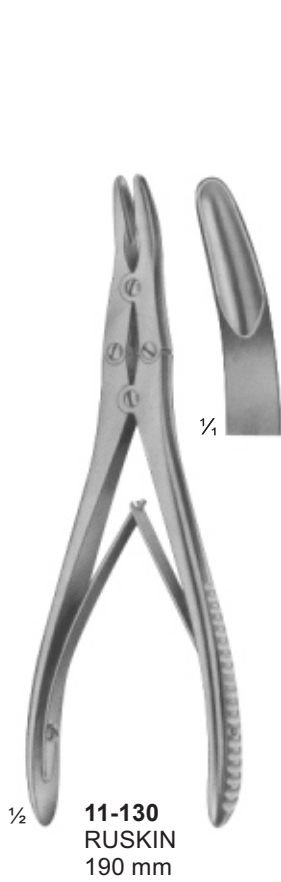

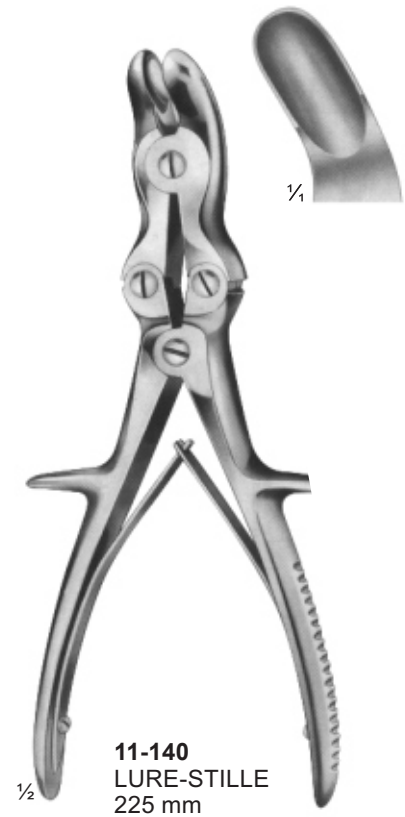
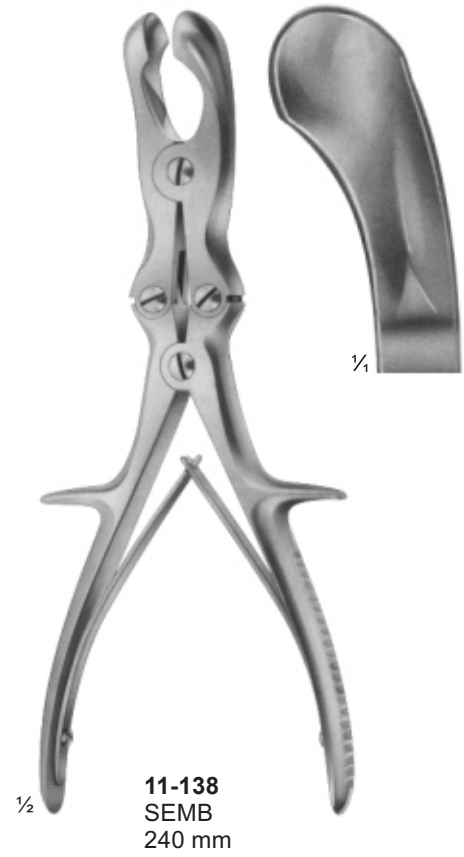
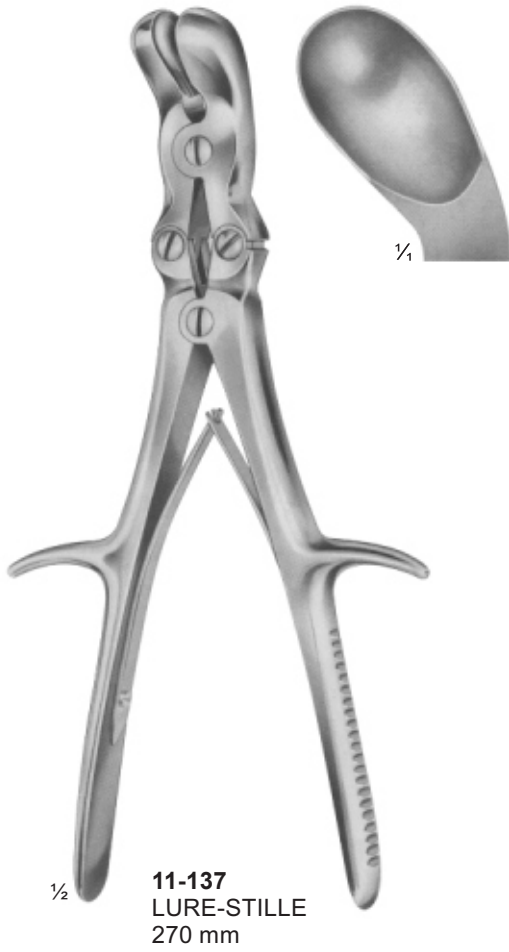

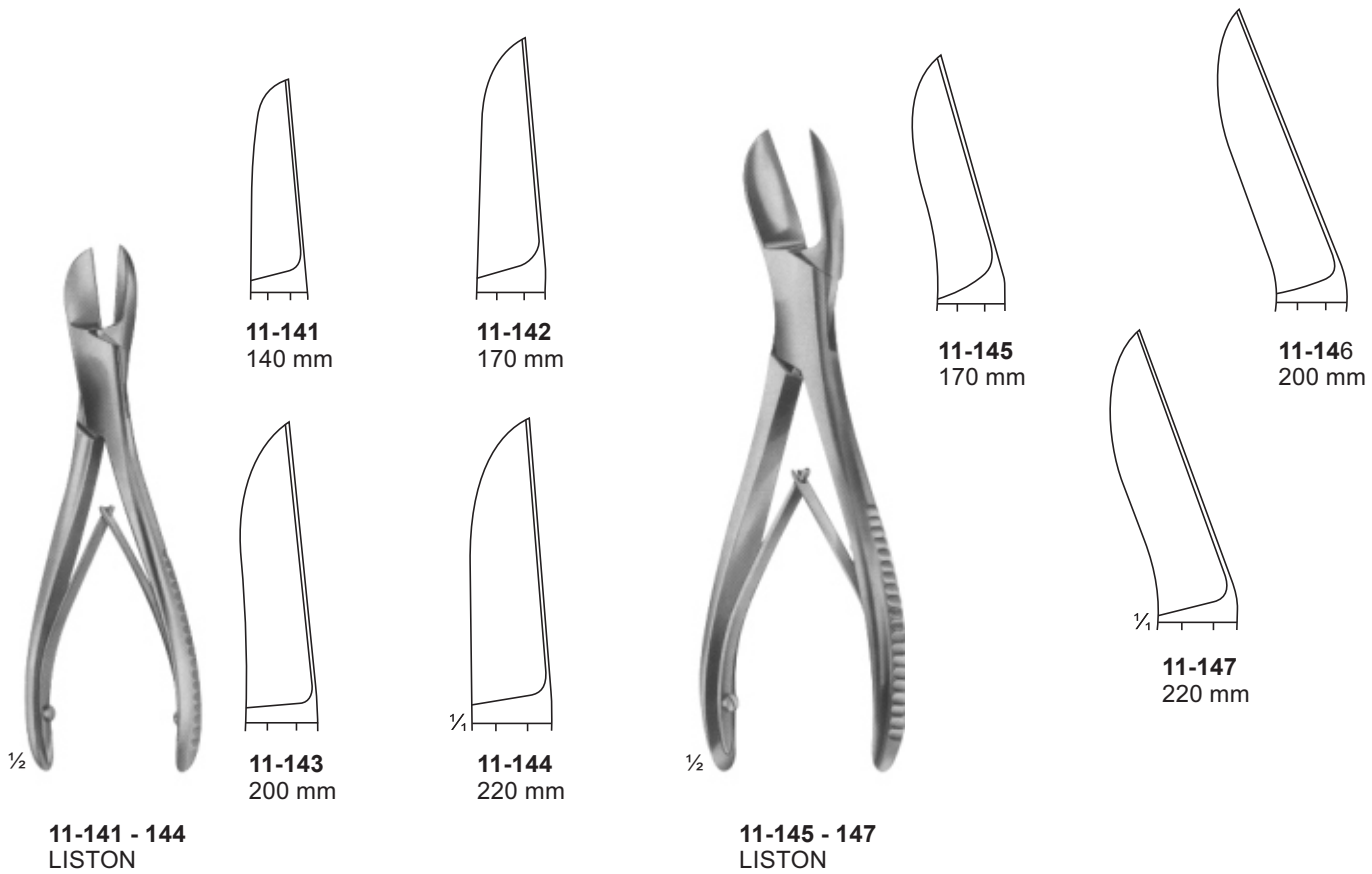



11-148
BOHLER
145 mm

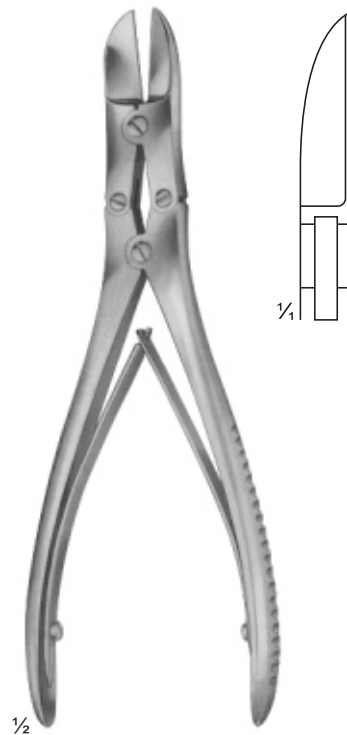

11-149
RUSKIN-LISTON
190 mm

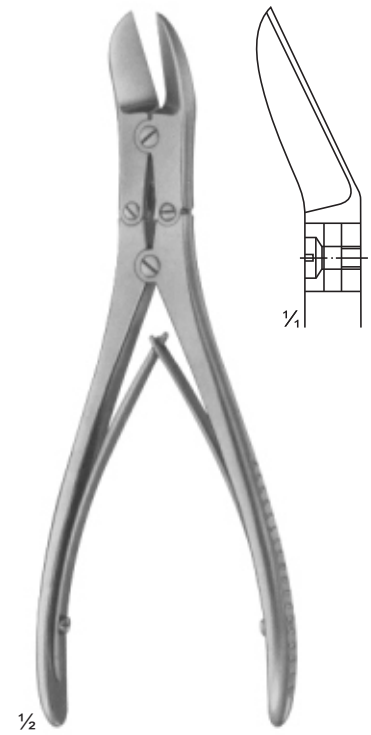

11-150
RUSKIN-LISTON
190 mm

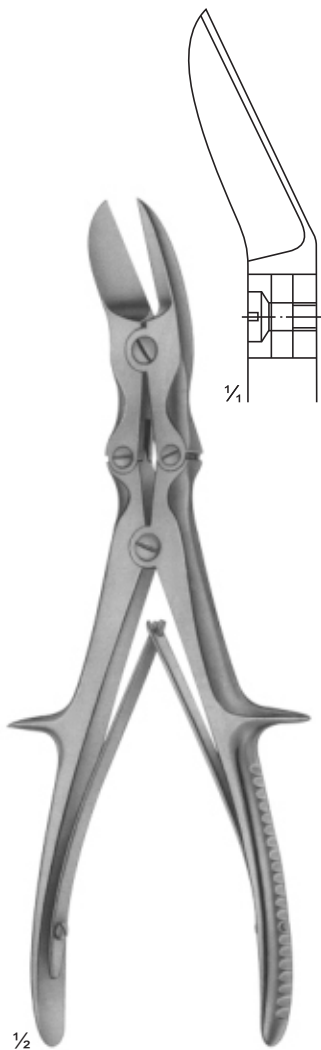

11-151
LISTON
 curved on flat
 240 mm

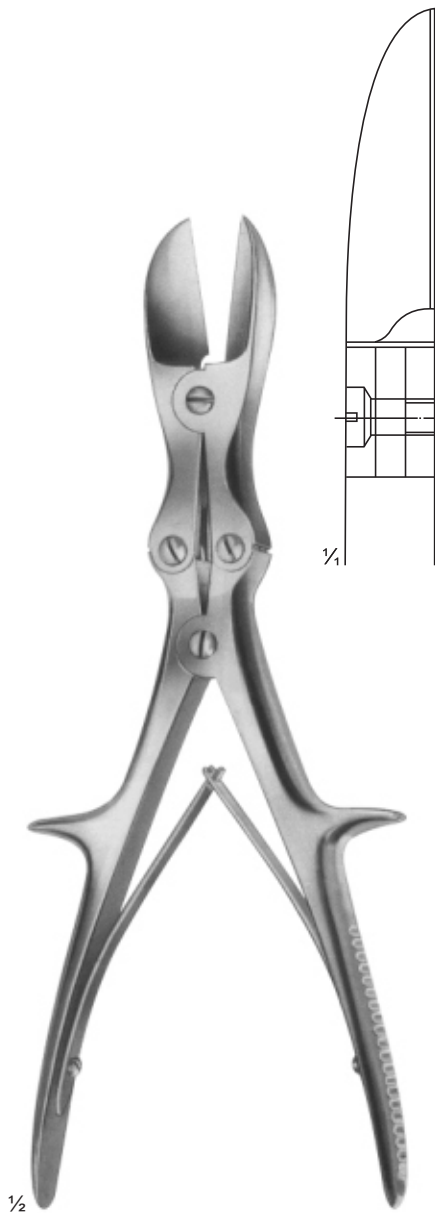

11-152
LISTON
 straight
 280 mm

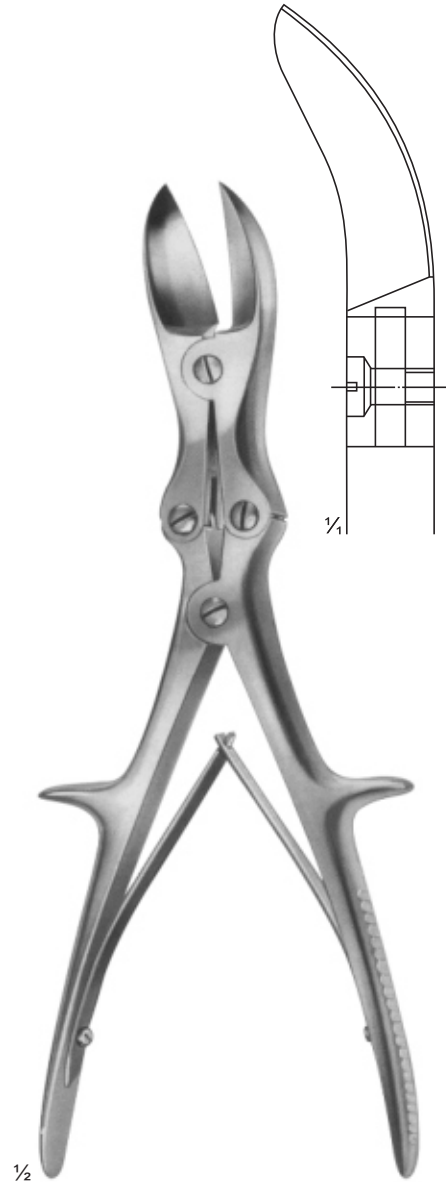

11-153
LISTON
 curved on flat
 280 mm



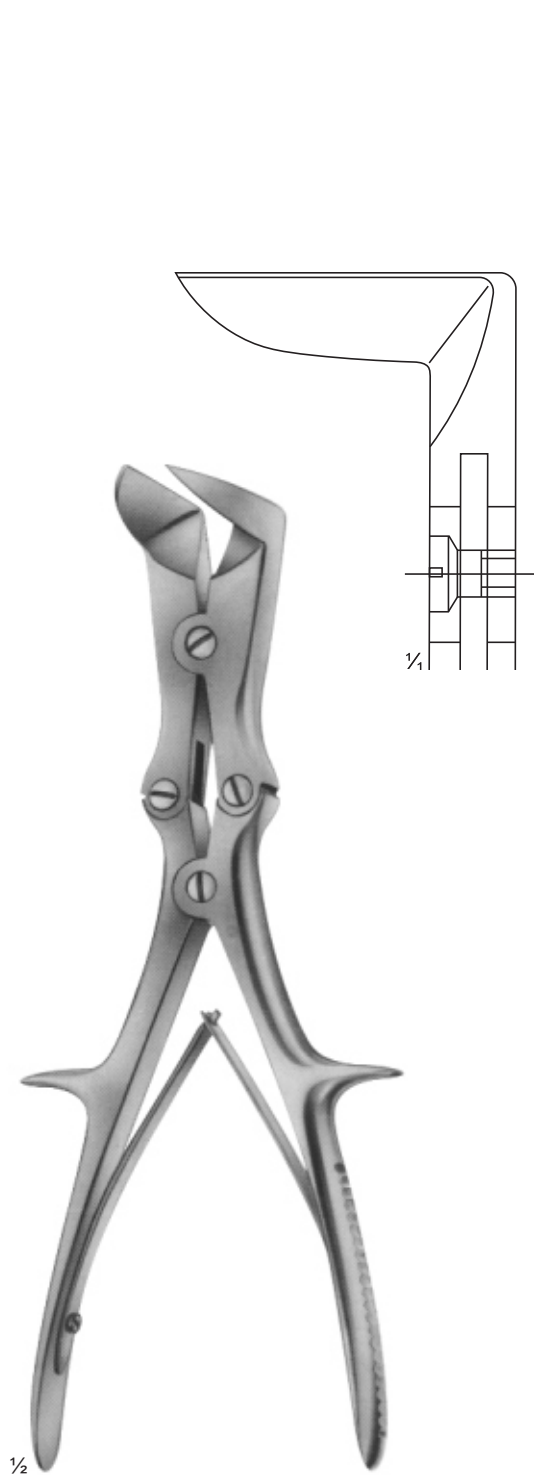

11-154
LISTON-STILLE
265 mm

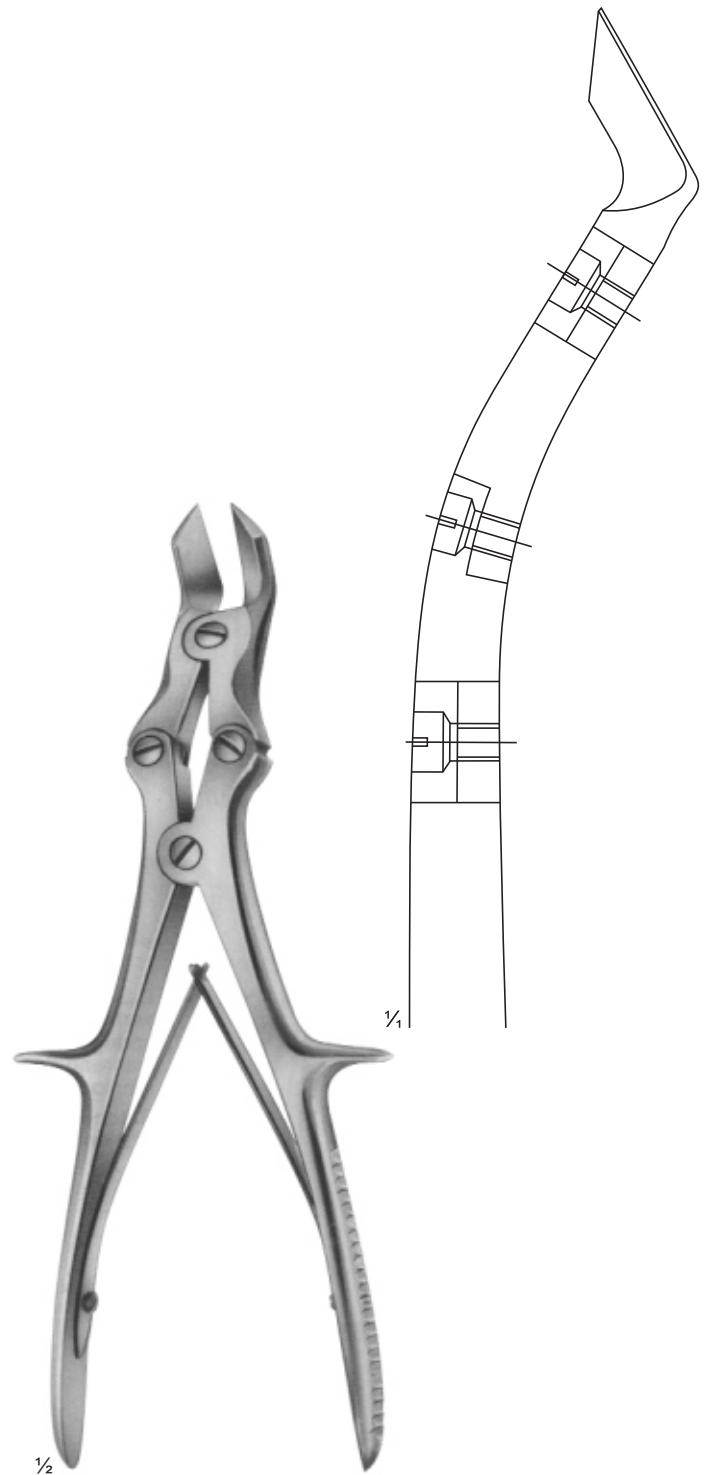

11-155
LISTON-KEY-HORSLEY
(TUDOR EDWARDS)
255 mm

Scissors With Tungsten Carbide Inserts
 Scheren Mit Hartmetall-wendeplatten
 Tijeras Con Insertos De Carburo De Tungsteno



STANDARD
 14-101 - 103

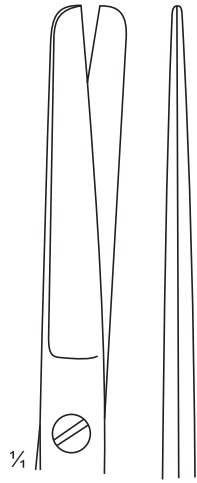

14-101
 145mm



14-102
 165 mm

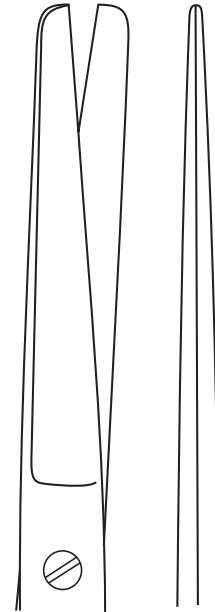

14-103
 185 mm



STANDARD
 14-104 - 106



14-104
 145 mm



14-105
 165 mm



14-106
 185 mm

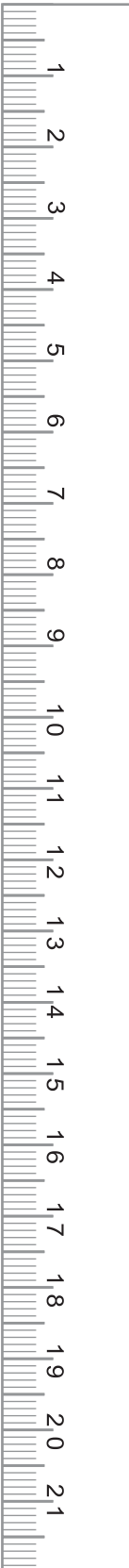

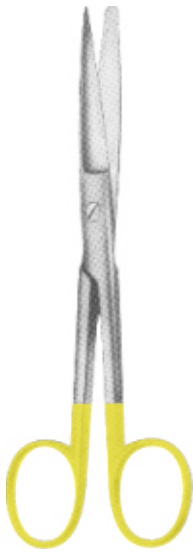

STANDARD
14-107 - 109

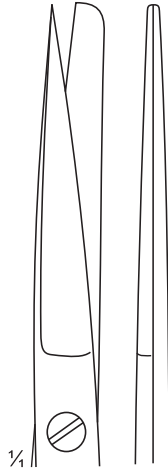

14-107
145 mm

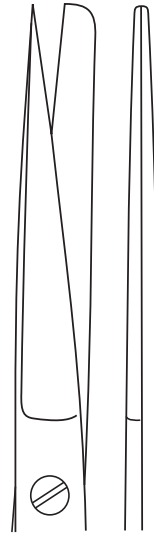

14-108
165 mm



14-109
185 mm

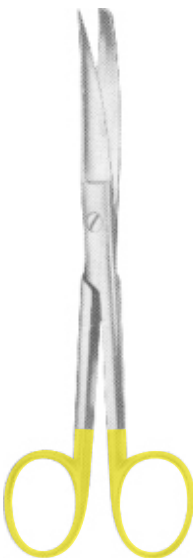

STANDARD
14-110 - 112



14-110
145 mm



14-111
165 mm

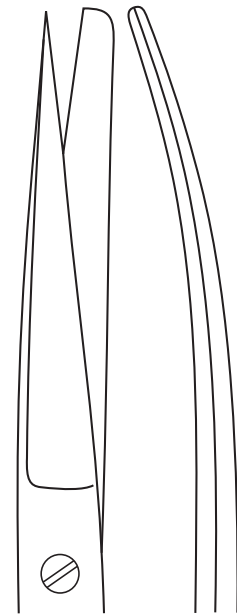

14-112
185 mm

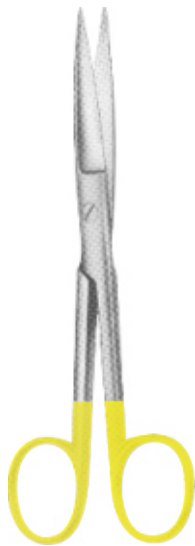

STANDARD
 14-113 - 115

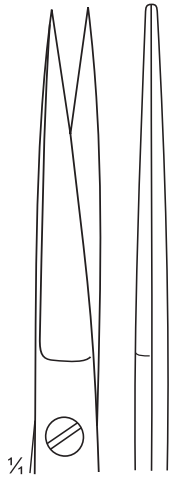

14-113
 145 mm



14-114
 165 mm



14-115
 185 mm



STANDARD
 14-116 - 118

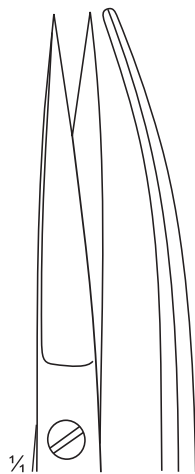

14-116
 145 mm



14-117
 165 mm



14-118
 185 mm



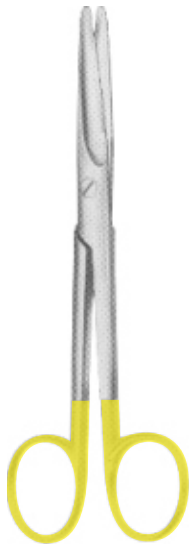

MAYO
14-119 - 121



14-119
145 mm

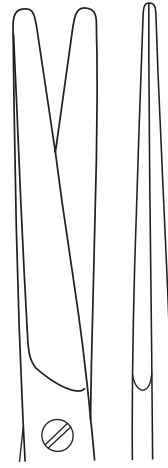

14-120
170 mm

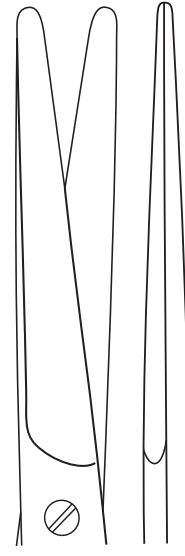

14-121
230 mm



MAYO
14-122 - 124



14-122
145 mm



14-123
170 mm



14-124
230 mm

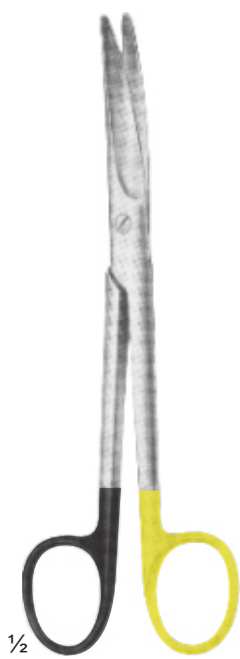

MAYO
14-125 - 127



14-125
140 mm



14-126
170 mm



14-127
230 mm





MAYO-STILLE
14-128 - 129

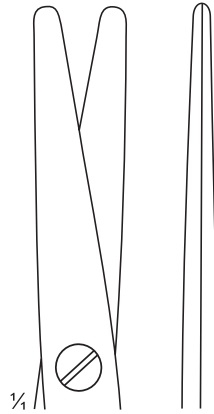

14-128
150 mm

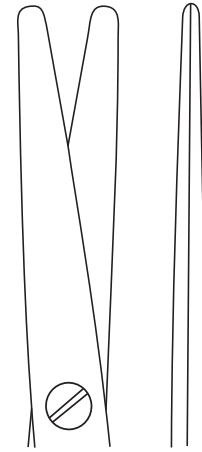

14-129
170 mm

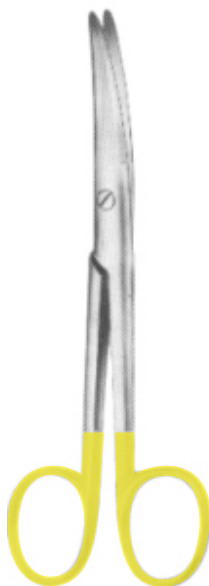

MAYO-STILLE
14-130 - 131

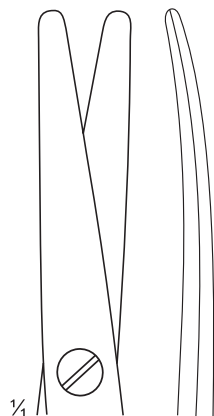

14-130
150 mm

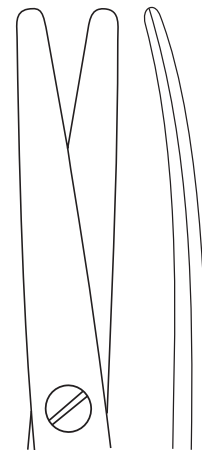

14-131
170 mm



METZENBAUM
 14-132 - 133

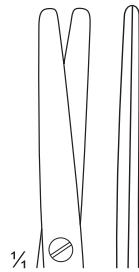

14-132
 115 mm

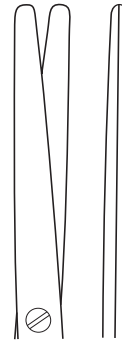

14-133
 145 mm



METZENBAUM
 14-134 - 135



14-134
 115 mm

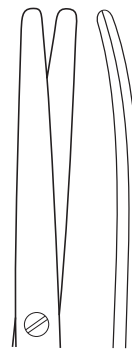

14-135
 145 mm





METZENBAUM
14-136 - 141

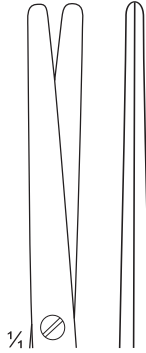

14-136
180 mm

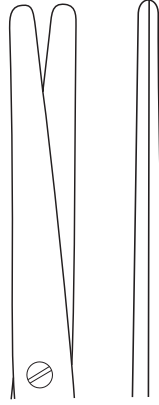

14-137
200 mm



14-138
230 mm

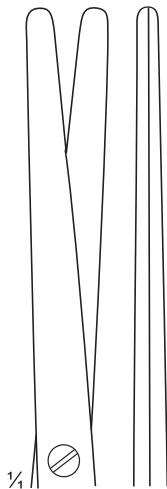

14-139
250 mm

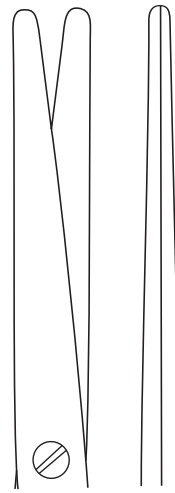

14-140
280 mm

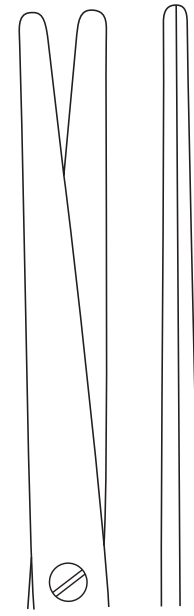

14-141
300 mm

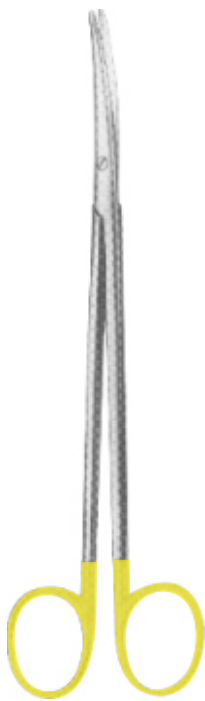

METZENBAUM
 14-142 - 147

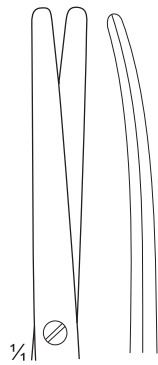

14-142
 180 mm



14-143
 200 mm



14-144
 230 mm



14-145
 250 mm

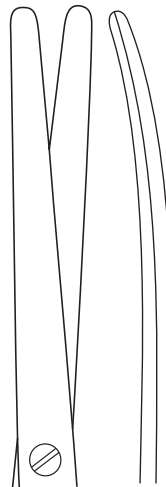

14-146
 280 mm



14-147
 300 mm



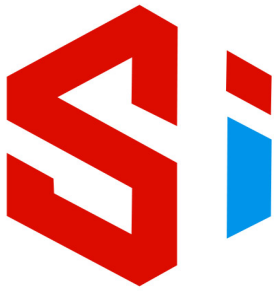

SNAZAN
INTERNATIONAL

SURGICAL INSTRUMENTS

Life Saving Instruments

Inquiry now Today Call us!
WhatsApp# +92 306 7524947

for Email
info@snazanintl.com

Contact address
New Adalat Garha
Sialkot 51310, Pakistan

